



Jefferson County Sheriff's Office

Columbine Documents

JC-001-025923
through
JC-001-026859

Stuart Hall

ERIC

60

steno. book

60 sheets • 6 x 9 in.
gregg rule white



Stuart Hall co., inc. KANSAS CITY, MO. 64108 no. 6239

JC-001-025923

2/28 Randy? Brown 972-0602

believing Eric vs wife

in his face

damages not there yesterday

sure it wasn't there before $\frac{1}{2}$ "

yelling, yanking on car door

4th hr

Eric talking

3 other kids

husband talked to Dean

being little bully

Zach's parents incident

3 pushes, yelling

crack in windshield

aggression

disrespect

idle threats of physical harm, property damage

overreaction to minor incident

JC-001-025924

3/3

Columbia H.S.

982-4400

Mr. ^{Craig} Place - Dean

Brooks Brown

- Eric wants to talk to

Brooks with an adult present

- Acquisitions

- Snow boots
- damage to Brooks car
- windshield damage

- plotting against friends
house - other boys involved
including Brooks

- alcohol -

- ~~denial~~ -

we have to
take care of
off school
property

Would talk to Eric today &
other boys poss. together. Very
concerned about alcohol acquisition
would get police involved if necessary

- Talked to ERIC: Basically finished
leave each other alone
don't talk about it.

1) Snow
Boots
and stuff

agreed,
all discussion
is over

3/4

Denial of ~~own~~ ^{Subject} knowledge
about alcohol ^{subject} between
he & me. Didn't
know what Mr. Place
was talking about.

- Problem of common friends
- Brooks most concerned
about his car

Told Mr. Place 3" crack
in windshield

- Over & done - don't discuss
c friends

3/3

Zack Heckler - 978-0098

~~Veronika~~ Veronika

Brook + Nick - Zack's sister

Damage to Brooks car

Damage to

Nick's house -

Zack told Nick
about Brooks + Eric

that Brooks would
leave Eric there.

Shoe was I.P. and 1999
at Nick's

Sue . 972-1131

Nick -

Bonnie Baumgarten -

JC-001-025927

4/18

Bonnie Baumgard - 973-9536

- Has not contacted Police
- No tree damage
- glued door
- T.P.

post
problems

- Did not find out
- who did above

Does not know of problems between Eric & Rick

Veronica Hackler - 978-0098

- No complaints about Eric
- Knows nothing

JC-001-025928

4/19 Police Officer - Jeffco. Co.
Deputy A.D. Walsh - 271-5685

Jeffco Co. - 271-0241 (number he called from)

- Tree Damage - Did you see?
- Talk directly to Brooks Brown?
- We feel victimized, too.
- Brooks Brown is out to get Eric
- Suggestions? Talk to Browns? 3rd party
- Dean of Students
- We don't want to be accused ^{supposedly} ~~ever~~ ~~of~~ ~~something~~ ~~happening~~. Eric ~~caused his losses~~ is not at fault

Not available until 4/23 -

Brooks had problems in other loop
Manipulative + Con Artist

4/24 If
deputy returned my
call

Future problems - Mediator?
lawyer?
(@both)

"mediation services" thru
Jeffco County

4/27 - called left mess -

no return

Judy?
Brown - 972 - 0602

Follow-up call
Any further problems between
Eric + Brooks?

Eric hasn't broken promise
to Mr. Place - the Dean - about
leaving each other alone.

You told me of past problem
= another but have you
checked = his parents?

We feel victimized, too

Manipulative
Con Artist

JC-001-025930

1/29/98

Dept T.S. Walsh, Dept Phil Lebeda

Dispatch 277-0211

1st degree criminal trespass

Class V felony 1-3 yrs \$1,000-100,000

Bob's Towing 500 W. Yale 789-2593

\$130.25

Juvenal Assessment Center 271-4567

Nora

1st offense

Jervinelle

admitted guilty

willing to do community service & counseling

Plead guilty

- Necessary to be represented in court?

JC-001-025931

1/31

271-4555 730-2400

Kelly - Family Adolescent Crisis Team

Insurance - mental health

Jericho Road - 8 Wbr

Fed Corr. Ctr

Anger Management

Life Management 940-8103

anger management

Therapist Stu Bredy 233-1440

Lakewood - adolescent counseling

mental Health Center 425-0300

sliding fee scale

School counselor?

Juvenile Assessment Center - 6mo contract

Diversion - comm. service

Probation

271-4567 Justin til 10pm Thurs-Sun

call to have him explain ramifications

what to expect in court

JC-001-025932

1/31

probation

from
Justin &
Eric talked

take any chances for

~~reformation~~ or diversion

refer to

asse. center

talk to DA and Deputy

2/1/98

Don Jacobs (Sasha's dad)

See psychologist for evaluation

- see what's going on
- determine treatment

Craig Rose 220-0577

Colo Blvd & Arapahoe

Mark Suyeishi 399-0888 290-0860

Orchard & I-25

cheaper?, sliding scale

called back 2/3 2200

seemed OK, would see Eric 1-3 times

to evaluate

\$100/50 min session

notigna

- I should call back to notify of going with another dr.

2/7 Suggested by Sandy

Gary Bergeron PhD

989-1100

3190 So. Wadsworth

Sgt Investigator

John Healy 271-5614

lmtc 2/2 1627, 2/3 0930, 1430

VIDEO, CD'S + CASE, glasses case, flashlight

Δ Attorneys for Zack Heble

FR 1
Date 1/30
to Crime

^{2/13} Attorney - Jerry Cardwell - 388-2104
Cherry Creek
owner of
Q. Van 5 (Arline Knows)

✓ talked to Dave LAW
see notes
→

Fees?

Δ Christopher Kenney - 753-4545
1225 17th 296-2828

Δ Troy Ciccarelli - 759-9669
950 So. Cherry #330

2/3 \$150/hr \$750 retained

hand-holding, comfort, explanations of process

Stu Brady 233-1440

Imtc 1207 2/3

Passage Ways Counseling 1901 Kipling

not Aigna

* Kevin Albert 794-7761

26 W. Dry Creek Cir #500

appt 3:00 mon 16 Feb

Auth No?

Behind Marie
Callendar
tall Bldg.

2/3

Dennis
Det Healy 271-5614

to finish his work by end of week

DA to notify by registered mail

\$100 - window

1718 - property

1st degree Crim. Tres - mis

Felony Theft

Crim. mischief - mis

Lic Psychologist \$100 / session :50

Cigna X2

diversion

2/12 4:30

Bob Miller Evidence - Impounded Property

271-5656

CR # 982218

call him at noon Fri

he will try to call Healy in AM.

7/13

Talked to Miller, said he needed a release note from Healy to release stuff. Miller currently has my stuff. left message with Healy.

D.A.

Courtlisters & in charge of filing

Public defenders - represent indigents

JC-001-025937

§ 213

Juvenile Division - 271-6866

Get copy of charges
from wherever he was
picked up + taken to.

D.A. + Judge decide on
Diversion - discussed after
court appearance. Have to
have a clean record for this.
Community service + classes

Police → file (reports) → D.A. office
evaluate + decide charges →
will go to court or diversion or
assessment center. Probably go to
court or diversion.

2/13 kmtc
Anderson, Grant

- 798-5053

26 W. Dry Creek Circle

\$ 500⁰⁰ retained
lv. 100⁰⁰

Q: call who to start Diversion?

2-3 months initial formal charge
petition received person

By pass court system

1) Diversion: Juvenile
informal procedure ^{of how to handle the case} vs. probation
Not meet c DA first

- 1) arraignment - advise of rights
1st appearance in court - ^{Don't} plead guilty
to all charges → pleads not guilty →
- 2) pre-trial conference c D.A. is scheduled.
- 3) Plea is reached juvenile assessment report.
- 4) sentencing

2/13

amount? Dave Law
Retainer: Non-Refundable 300 So. Jackson
125 per hr. ① Diversion — Sb. #530

call probation
for diversion plan
immediately

② restitution

5th Amendment

Civil case - "Sealing of records"

Bad choice to tell all that
evening

Filing Done?

Be careful what we said

Age 16 - Not contract - with attorney
Need Parents

yo - Representation at time of D.A.

yo - Preliminary hearing - poss. charges

Plead not guilty + speedy trial -
Pre-trial

Allen Karpelowitz - 271-6958
Diversion - Nikki - 271-6950

Need to be accepted into program

Alternative to court (Court fees \$ 250.00)

D. B. office screens case - decides
for diversion or court

- Receive petition of delinquency
in mail

(or)

diversion - notify by
phone call by
counselor

Supervised contract 6mo. - 1 yr.
classes - fee

Counseling, community
service (non-profit organization
church, schools)

Pay restitution to victim
thru diversion office

After time frame and if all is
done well - dismissed

3/3/98

Andrea Sanchez 271-6952 D.A. Office
~~Juvenile Diversion Office~~ in Jefferson County

Appt for interview - 3/19/98 3:00

main courthouse, ask front desk - diversion mtg
juvenile + at least 1 parent

Court date - probably within 1 mo.

plead guilty

enter diversion

Appt for orientation - 4/21/98 5:30-8:00

juvenile + at least 1 parent

One additional meeting requiring at least 1 parent

TBD

diversion program - 1 yr

charges held unless removed from program

charges can be expunged in 1 additional year

Bob Krehauser
Andrea
Kevin

Eligibility for Diversion

Limited Immunity

Answer truthfully

Not usable in court (ex. violence)

No weapons

Policy

JC-001-025943

4/7/98 - Andrea Sanchez

individual counseling - being

anger management 1 time

MADD victim panel 1 time 2 hrs

letter of apology to victim

Gov. Justice class 1 time

5 hrs. + parent, Saturdays

45 hrs com. ser.

4/27 - Diversion Orientation w/ Andrea

Day planner

JC-001-025944

KEVIN
HARRIS

1. unwilling to control sleep habits
2. unwilling to control study habits
3. unmotivated to succeed in school

we can deal with 1 and 2
TV phone computer job social
lights out

you must deal with 3

prove to us your desire to succeed
by succeeding, showing good
judgment, giving extra effort,
pursuing interests
seeking help, advice

phone
 not after 10
 not while studying
 computer 4 hrs
 interim report
 from Rockwell,
 miller
 assignment book
 bed 10:00
 unless studying

JEdwards

End	L	Eq	Rt	Quantity	Unit Amount
7:00 C WK				1.00 HR	
Transfer Action 1					
Subledger					
2292				CO	
Tax Rate/Area					
Transfer Number 274					
1:00 H WK HR					
Transfer Action 1					
Subledger					
5952				25	
Tax Rate/Area					
Transfer Number					

The document described below
has been removed

Description of Document: Eric Harris'
Childhood Medical Records

Date of Document: N/A

Reason for Removal

- Copyright
- Bomb-making instructions
- Medical Records
- Other

Comments: _____

#248

Correct ✓

Uylan/CUBO/d
P. 4, LA

The town, even at 1:00 AM, was still bustling with activity as the man dressed in black walked down the empty streets. The moon was barely visible, hiding under a shield of clouds, adding a chill to the atmosphere. What was most recognized about the man was the sound of his footsteps. Behind the conversations & noises of the town, not a sound was to be heard from him, except the dark, monotonous footsteps, combined with the jingling of his belt chains striking not only the two visible guns, in their holsters, but the large bowie knife, slung in anticipation of use. The wide-brimmed hat cast a pitch-black shadow of his already dimly-lit face. He wore black gloves, with a type of metal spiked-band across the knuckles. A black overcoat covered most of his body, small lines of metal & half-inch spikes layering upper portions of the shoulders, arms, and back. His boots were newly-polished, and didn't look like they had been used much. He carried a black duffel bag in his right hand. He apparently had parked a car nearby, & looked ready for a small war with whoever came across his way. I have never seen anyone take this mad-max approach in the city, especially since the piggies had been called to this part of town for a series of crimes lately. Yet, in the midst of the night life in the center of the average-sized town, this man walked, fueled by some untold purpose, what Christians would call evil. The guns slung on his belt & belly appeared to be automatic hand-guns, which were draped above rows of magazines & clips. ~~A~~ thin cigar, almost a sweet clovesque scent, emanated from his aura. He stood about six feet and four inches, and was strongly built. His face was entirely in shadow, yet even though I was unable to see his expressions, I could feel his anger, cutting thru the air like a razor. He seemed to know where he was walking, and he noticed my presence, but paid no attention, as he kept walking toward a popular bar, The Watering Hole. He stopped about 30 feet from the door, and waited. "For whom?" I wondered, as I saw them step out. He must have known their habits well, as they appeared less than a minute after he stopped walking. A group of college-preps, ~~about~~ nine of them, stopped in their tracks. A couple of them were mildly drunk, the rest sober. They stopped, and stared. The streetlights illuminating the bar & the sidewalk showed me a clear view of their stares, full of paralysis & fear. They knew who he was, & why he was there. The second-largest spoke up "Whatre you doin man..... why are you here...?" The man in black said nothing, but even at my distance, I could feel his anger growing. "You still wanted a fight huh? I meant not with weapons, I just meant a fist fight....cmon put the guns away, Fuckin pussy!!" said the largest prep, his voice quavering as he spoke these works of attempted courage. Other preps could be heard muttering in the backround "Nice trench coat dude, thats pretty cool there...." "Dude we were jus messin around the other day chill out man..." ... "I didn't do anything, it was all them!!" ... "cmon man you wouldn't shoot us, were in the middle of a public place..." Yet, the comment I remember the most was uttered from the smallest of the group, obviously a cocky, power hungry prick. "Go ahead man! Shoot me!!! I want you to shoot me!! Heheh you wont!! Goddam pussy...." It was faint at first, but grew in intensity and power as I heard the man laugh. This laugh would have made Satan cringe in Hell. For almost half a minute this laugh, spawned from the most powerful place conceivable, filled the air, and thru the entire town, the entire world. The town activity came to a stop, and all attention was now drawn to this man. One of the preps began to slowly move back. Before I could see a reaction from the preps, the man had dropped his duffel bag, and pulled out one of the pistols with his left hand. Three shots were fired. Three shots hit the largest prep in the head. The shining of the streetlights caused a visible reflection off of the droplets of blood as they flew away from the skull. The blood splatters showered the preps buddies, they were paralyzed to run. The next four preps were not executed so systematically, but with more rage from the man's hand cannon than a controlled duty for a soldier. The man unloaded one of the pistols across the fronts of these four innocents, their instantly lifeless bodies dropping with remarkable speed. The shots from ~~the~~ gun were felt just as much as they were heard. He pulled out his other pistol, and without changing a glance, without moving his death-stare from the four other victims to go, aimed the weapon out to the side, and shot about 8 rounds. These bullets mowed down what, after he was dead, I made out to be an undercover cop with his gun slung. He then emptied the clip into two more of the preps. Then, instead of reloading & finishing the task, he set down the guns, and pulled out the knife. The blade loomed huge, even in his large grip. I now noticed that one of two left was the smallest of the band, who had now ~~wet~~ his pants, and was hyperventilating in fear. The ~~prep~~ tried to lunge at the man, hoping that his football tackling skills would save his life. The man sidestepped, and made two lunging slashes at the ~~other prep~~. I saw a small trickle of blood cascade out of his belly and splashing onto the concrete. His head wound was almost as bad, as the shadow formed by the bar's lighting showed blood dripping off his face. The last one tried to run. The man quickly reloaded, and shot him thru the lower leg. He instantly fell, and cried in pain. The man then pulled out of the duffel bag what looked to be some type of electronic device. I saw him tweak the dials, and press a button. I heard a faint, yet powerful explosion, I would have to guess about 6 miles

He smoked a

white

prison

the smallest one,

away. Then another one occurred closer. After recalling the night many times, I finally understood that these were diversions, to attract the cops. The last prep was bawling & trying to crawl away. The man walked up behind him. I remember the sound of the impact well. The man came down with his left hand, right on the prep's head. The metal piece did its work, as I saw his hand get buried about 2 inches into the guy's skull. The man pulled his arm out, and stood, unmoving, for about a minute. The town was utterly still, except for the faint wail of police sirens. The man picked up the bag and his clips, and proceeded to walk back the way he came. I was still, as he came my way again. He stopped, and gave me a look I will never forget. If I could face an emotion of god, it would have looked like the man. I not only saw in his face, but felt emanating from him power, complacency, closure, and godliness. The man smiled, and in that instant, thru no endeavor of my own, I understood his actions.

^
—

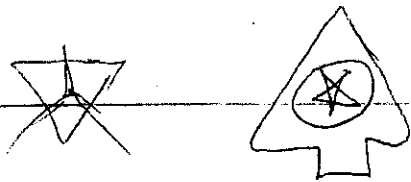

Gunpowder. The room smelled of gunpowder among other combustible chemicals, sacs of buckshot, messily piled up along the desk, & spilling out onto the floor, there to trip the unwary visitor. The black powder-scented air covered the room & made a fine black dust settling over the Federal Shotgun shells & the shell-making machine, on the bed the unmade, unmade, old tired bed, near his tools the AR-10, the Uzi lying ~~there~~ here in hibernation. Back on the desk as I ~~was~~ ^{was} ~~there~~ 9mm bullets and magazines ~~scattered~~ onto the floor. I found among the chemical stains & burn marks, an ancient photo album, open to pages of people at the beach. ~~There~~ These people were in the midst of a vacation I presumed, ~~yet there was~~ a hint of happiness. Yet, on these pictures a withered black X than some people's faces. The scent of ammonia & gunpowder overwhelmed me, as I went to a window to let some air and light into the dank, abandoned room. The blinds didn't work, so old, and I eventually cut them down with a large knife, one I found sitting by the bed, set as to guard the ~~room~~ almost. There was dried blood along the tip of the blade, cobwebs caked over gallons of ~~deep~~ deep rock & the canned goods, stockpiles of green beans, chiles, soup, beer, and corn.

skells ^{militant}

powder

pallots

clips

bullets

fuses

timers

shotgun

AR-10

VZi 9m

Calico Lib. 3

Photo album w. XS

pictures of famous ppl.

lighters

matches

potassium-nitrate

NO₃

gasoline

keosene

thermite

canned food

~~water~~ water

beer

sniper rifle

shotgun shells - line

old

unused

dead

I.S.A.E.

(Institute for Substance Abuse Education & other court related programs)
2480 West 26th Avenue Suite 4-B • Denver, Colorado 80211 • (303) 433-1900 / Fax 455-6012 • Toll Free 1-888-565-1900

Name Eric Harris D.O.B. 4/9/81 Phone# 932.8881

Court/Agency Jirco District Case # 98JD336

Date Referred 8/3/97 Deadline to Complete 12/1/97

As a condition of your sentencing you are hereby ordered to attend and complete the following:

<input type="checkbox"/> Alcohol Drug Class	\$50.00	9am-4pm	2 day seminars (Saturday/Sunday same weekend) (Pre-registration required)
<input type="checkbox"/> Defensive Driving	\$50.00	9am-5pm	<input type="checkbox"/> Intensive Alcohol Drug Program \$95.00 9am-4pm
<input type="checkbox"/> Discovery Class	\$50.00	9am-4pm	<input type="checkbox"/> Adult Offender <input type="checkbox"/> Juvenile Offender/Parent must attend
<input type="checkbox"/> Petty Theft Class	\$50.00	9am-4pm	<input type="checkbox"/> Petty Theft Repeat Offender Program \$95.00 9am-4pm
<input type="checkbox"/> Teens and Tobacco	\$30.00	10am-2pm	<input type="checkbox"/> Adult Offender <input type="checkbox"/> Juvenile Offender/Parent must attend
<input checked="" type="checkbox"/> Violence is Preventable	\$60.00	9am-4pm	<input type="checkbox"/> Violence Intervention Program (VIP II) \$95.00 9am-4pm
			<input type="checkbox"/> Adult Offender <input type="checkbox"/> Juvenile Offender/Parent must attend

Class Date: _____ Class Location: _____

You must contact I.S.A.E. within 48 hours to register for a class if no date has been assigned.

Cost: **MONEY ORDERS ONLY due on the day of class.** (NO cash or checks please!)

Upon completion of class you are ordered to complete a 300 word essay to the satisfaction of the court.

Essay Due Date: 12/8/98 Essay to be turned into agency who referred you.

**\$10.00 Rescheduling fee for failure to give notice by 9 am the Friday prior to your class.

Parent or Legal Guardian Signature _____ Client Signature _____

White copy to Court/Agency. Canary Copy to I.S.A.E. Pink copy to Client Court Agency/Signature _____

R e c e i p t

District Attorney - First Judicial District

Diversion Services

10/20/98

13:40:32

No. 9539

Received From: Harris, Eric

Case No. : 30 98JD00336

Amount Paid : \$12.50 Type of Payment: MO

Description : 10-15-98

Received By : RIEDELP

Counselor :



Account Description	Amt Applied	Balance Due
-----	-----	-----
VALE Fund	.00	.00
Victim Compensation	.00	.00
Court Costs	.00	.00
Scans & Insurance	12.50	-.50
-----	-----	-----
Statement Totals:	12.50	-.50



Where you belong.

FOR INFORMATION: 689-7800
TELEPHONE: 689-7990

TRANSACTION DESCRIPTION

TRANSFER FROM
FOR AMOUNT OF \$33,550.75 ON
ON 101598 EFFECTIVE 101598
TLR:6 VE TESS C- 13:55:00
ACCOUNT NUMBER

BELLE U HARRIS
LITTLETON CO 80128

ACCT DESCRIPTION	NEW-BALANCE	FEE INT-PAID NXT D
S 1 S1-SAVINGS 2.96% APR	415.19	0.00
MONEY ORDERS	72.50	
		4.00

LEGEND: S1 - Primary Savings S4 - Checking S7 - Money Market S8 - IRA S9 - Christmas Club L4 - Line - of - Credit Loan

TEXACO
 6798 W. OTTAWA
 LITTLETON, CO 80123
 Store: 2106

04-20-1999 Register: 2
 CLERK:004 Sale no:222955
 09:12:22

Item	Sz	Qt	Total \$
Propane No	SIN	1 T	49.99

Sub Total.....\$	49.99
Tax.....\$	2.40
Total.....\$	52.39
Cash.....\$	53.00
Change.....\$	8.61

Thank you!

THANK YOU FOR SHOPPING CONOCO
 7540 W. CHATFIELD
 PHONE 948-8916
 Please come again

2 PROPANE BOTTLE
 @ 37.95 ea. 75.90T

SUBTOTAL: 75.90

TAX: 3.26

TOTAL: 79.16

CASH 80.00

CHANGE: 0.84

0538795 04/20/99 08:36:45

By: KLT Drawer: A

Top Copy - Merchant
 Bottom Copy - Customer

THANK YOU FOR SHOPPING CONOCO
 7540 W. CHATFIELD
 PHONE 948-8916
 Please come again

2 PROPANE BOTTLE
 @ 37.95 ea. 75.90T

SUBTOTAL: 75.90

TAX: 3.26

TOTAL: 79.16

CASH 80.00

CHANGE: 0.84

0538795 04/20/99 08:36:45

By: KLT Drawer: A

Top Copy - Merchant
 Bottom Copy - Customer

Dylan Klebold
10.6.98
LA., Per. 6

The Mind and Motives of Charles Manson

- I. Biography and Opinion.
 - A. Brief biography.
 - 1. As a kid.
 - 2. As a teen.
 - 3. As an adult.
 - B. Brief Biographies of his family members.
 - 1. Pat Krenwinkle
 - 2. Leslie Van Houten
 - 3. Others
 - C. Description of his control over his family.
 - 1. Structure of their family.
 - 2. Why his family followed him.
 - D. Relation to his and his followers' beliefs, actions, and their crime and punishment.
 - E. Thesis.
- II. His Beliefs.
 - A. Regarding himself.
 - 1. Compared to Jesus.
 - 2. Compared to Satan.
 - B. Regarding his family.
 - 1. Their place in life.
 - 2. Their journey toward him.
 - C. Regarding nature and the earth.
 - 1. Its place in life.
 - 2. Its deserved respect.
 - D. Regarding other people.
 - 1. Their ignorance.
 - 2. Their disrespect to ATWA.
 - E. Regarding the media and the law.
 - 1. Their supposed lies.
 - 2. What they 'tried' to do to him.
- III. His Actions.
 - A. Where they lived.
 - 1. Location(s).
 - 2. How they got their living space.
 - B. How they lived.
 - 1. What they did.
 - 2. Drug influence and consumption.
 - C. Who and why they killed.
 - 1. Who they killed.
 - 2. Why they killed.
 - 3. Strange cult-oriented additives.
- IV. His Crime and Punishment.

- A. How they were caught.
 - 1. Their arrests.
 - 2. Evidence.
 - B. Summary of his victims.
 - C. His trials, verdicts.
 - 1. Manson's court history.
 - 2. The court history of Manson's family.
- V. Today's Thoughts
- A. Today's involvement with society.
 - B. His views/beliefs today.
 - C. His family's views/beliefs today.

good revision

Dylan Klebold
10.6.98
LA., Per. 6

omit intro & conclusion

The Mind and Motives of Charles Manson

I. Introduction.

A. Brief biography.

1. As a kid.
2. As a teen.
3. As an adult.

1) Part
2) Leslie
3) others

B. Brief Biographies of his family members.

1) Main family members.

C. Description of his control over his family.

1. Structure of their family.
2. Why his family followed him.

D. Relation to his and his followers' beliefs, actions, and their crime and punishment.

1) Overview of II, III, and IV.

E. Thesis. 1 - overview of III

II. His Beliefs. 3 - overview of IV

A. Regarding himself.

1. Compared to Jesus.
2. Compared to Satan.

B. Regarding his family.

1) Their place in life. 2 - Their journey toward him

C. Regarding nature and the earth.

1. Its place in life.
2. Its deserved respect.

D. Regarding other people.

1. Their ignorance.
2. Their disrespect to ATWA.

E. Regarding the media and the law.

1. Their supposed lies.
2. What they 'tried' to do to him.

III. His Actions.

A. Where they lived.

1) Location(s). 2 - How they got the living space

B. How they lived.

1. What they did.
2. Drug influence and consumption.

C. Who and why they killed.

1. Who they killed.
2. Why they killed.
3. Strange cult-oriented additives.

IV. His Crime and Punishment.

A. How they were caught.

1. Their arrests.
2. Evidence.

needs 2

- B. Summary of his victims.
 - 1. Complete lists of ALL victims, who they were.
 - 2. What charges were pressed, what laws were broken.
 - 1. ~~All the charges involved.~~
 - 2. ~~What counts of murder.~~
- D. His trials, verdicts.
 - 1. Manson's court history.
 - 2. The court history of Manson's family.
- 3. Where he and family are today.
 - 1. ~~Where Manson is.~~
 - 2. ~~Where his family is.~~

- ~~on~~
 - A. ~~Sum up information.~~ 2-III 3-IV
 - 1. ~~Sum up charges, I, II, and IV.~~
 - B. Today's involvement with society.
 - 1. Attempted followers.
 - C. His views/beliefs today.
 - 1. Views about his past, present, and future.
 - D. His family's views/beliefs today.
 - 1. His family's views about his past, present, and future.

~~THE~~
 MANSON'S
 influence
 today

The Mind and Motives of Charles Manson

I. Introduction.

Family's biographies
synthesizes

- A. Brief biography. - 1. As a kid, 2. As a teen, 3. As an adult
- B. Relation to his beliefs.
- C. Relation to his and his followers' actions.
- D. Relation to his crimes and punishments.
- E. Thesis.

C. Explain his control over family

II. His Beliefs.

- 1. Regarding himself. - 1. Comparing to Jesus, 2. compared to Satan
- 2. Regarding his family.
- 3. Regarding nature and the earth.
- 4. Regarding other people.
- 5. Regarding the media and the law.

1. Their place in life
2. Its deserved respect
1. Its place in life
1. Their disrespect to him
2. What they tried to do to him

III. His Actions.

- 1. Where they lived. - Location
- 2. How they lived. - 2. what they did
- 3. Who and why they killed! - 1. who, 2. why

IV. His Crime and Punishment.

- 1. Summary of his victims. - Lists, 3. strange things
- 2. What charges were pressed, what laws were broken. - 1. all charges, 2. what courts of law
- 3. His trials, verdicts. - Lists of trials for Manson, trials for family
- 4. Where he and family are today.

How they were caught

V. Conclusion

- 1. Sum up part II
- 2. Sum up part III
- 3. Sum up part IV
- D. Today's involvement w. his family (90's days)
- E. His views today
- F. Family's views today.

him Family members

Outline format

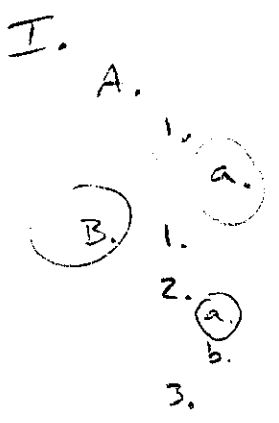

Senior Predictions

Great font - what is it?

Dylan Klebold

8-20-98

KA, per. 6

@ C.C.B, Mr. Webb

Really - is the paper you do need to use a standard font

STATE WORKS... policy. All major essays must be printed on...

8	8
6	7
D	6
C	6

29/40

Tyler Gelert
8-26-98
LH, per. 6

Senior Predictions

~~The~~ Senior year approaches for the class of 1999. As this year is just beginning, I, as well as most other seniors, am unsure as to what to expect in our last curricular school year. However, there are some things I do expect from this upcoming year. Those being having more fun for a year than previous years, college preparation, & the need for decision making about my future (career & living).

I predict that myself, as well as everyone other senior, will have more fun this school year than any others in the past. I will have more freedom, with the same basic guidelines, meaning more time for less responsibilities. (i.e. Having a later curfew, but not having to get up on weekends, like many employed adults do.) Also, the fewer hard classes on my schedule add to the non-difficulty. That, in comparison, would be 5 classes vs. 6 or 7 in previous years. Those are two of many factors that would make this year more enjoyable than years before.

This stands out

awk in class

Another foreshadowed ^{awk} aspect of my senior year would be deciding about colleges. My predicted major is in the computer field, which helps me since the demand for knowledgeable computer technicians, network administrators, & programmers is high. With that being my major, picking colleges with an acceptable technology program might prove difficult. Visiting campuses is one part of preparation. I expect to take at least two road trips around Colorado, just for looking at colleges & deciding where I would want to go. Another part of preparation would be filling out applications, & possibly taking exten extensions to the SAT & ACT. I do not have any colleges in mind at this point in time, but I have not yet begun to



Printer
screwed
up

redundant

look at specific colleges yet. These & other college-oriented activities are foreseen & usually necessary within the next year.

The crucial need for decision making within the next year is definitely foreseen. I (probably) will be deciding what the rest of my life looks like. In these decisions are where I would want to live. About this I have no idea yet. Another one of these decisions will be what my career will be, & where I want to pursue that career. This partially ties in with college preparation, unless I have an unseen change in college majors. These & other important decisions await my response within my senior year.

repeated

(cut off
3rd page)

In conclusion, senior year poses many new factors. Those being the change in my social life, the college preparation, & the need for decision making that might tell me what my future will look like. Although these are things that are predictable, there will still be questions.

repeated

#262

The Nazi Culture

by

Eric Harris

Mr. Webb

Composition for the College Bound

November 13, 1998

JC-001-025964

Nazism was a form of government unlike any other in history. Led by Adolf Hitler, the Nazis had distinct beliefs and policies, severe racism and hatred, strong, new family values, and plans for future Germany and the world. The Nazi party came to power in the early 1930s, thanks to Adolf Hitler. Hitler was loved and admired by all of his followers. The Nazis derived many symbols from ancient runes and made code names for things like their concentration camps. They also formed several new laws and restrictions. Racist beliefs and violent actions were all part of everyday life in Nazi Germany. Concentration camps killed millions of people using gas chambers and firing squads. The Jewish race was considered inferior, and therefore extremely and harshly discriminated against by law. Family values were encouraged, education was reformed, the women's roles were outlined, the Aryan race was to be the only race, and law controlled breeding. Education was reformed in order to benefit the state, not the individual. The woman's main role was to bear children, cook, and clean. The Aryan race was the only "superior" race, so therefore Hitler wanted Germany to have all Aryan citizens. Only the elite would reproduce and inferior races were restricted from breeding with the superior race. Hitler had several plans for his new Germany, and for the world as well. Hitler wanted leaders in Germany. He also wanted to control what everyone saw and heard to maintain a working state. The youth of the world was to be under Nazi control, and Europe and Russia were to be conquered. Approximately eleven million people died as a result of the Nazis. The Nazis were one of the most racist forms of government ever.

wow

The Nazi Culture

Thesis: Nazism was a form of government unlike any other in history, with their beliefs and policies, their racism and hatred, their very strong family values, and the plans they had in store for the rest of the world.

- I. The Nazis
 - A. How they came to power
 - 1. Hitler
 - 2. Love for Hitler
 - 3. Energy
 - B. Who they were
 - 1. Runes
 - 2. Code words
 - C. Policies
 - 1. Censorship
 - 2. Control
 - 3. Euthanasia
 - 4. Aliens
- II. Racism and violence
 - A. Concentration camps
 - 1. Doctors and wives
 - 2. Shootings
 - 3. Gas chambers
 - 4. Reinforcement of hatred
 - B. Jews
 - 1. Insults and racist comments
 - 2. Inferior race

III. Family values

A. Education

1. What education would benefit
2. Textbooks
3. Science in racism

B. Women

1. Children
2. Discrimination

C. Aryan race

1. Mental
2. Physical

D. Breeding

1. Only the elite would reproduce
2. Jews as inferiors

IV. Future Plans

A. Europe

1. Leaders
2. Freedoms
3. Censorship of the nation

B. World

1. Youth
2. Russia
3. Space

The Nazi Culture

How many people can a football stadium hold? Can it hold fifty, sixty thousand? Most stadiums can. Now, picture a stadium filled, not just seats but the field and all the air above it, with dead men, women, and children. That is just a fraction of the casualties inflicted by the Nazis, also known as the Third Reich. Through the 1920s and 1930s ideas from the past and basically anything that seemed interesting to Adolf Hitler was added into the government policies. Nazism was a form of government unlike any other in history, with their beliefs and policies, their racism and hatred, their very strong family values, and their plans for the rest of the world.

interesting opening

The word "Nazi" itself is synonymous with "racist." The Third Reich, in its early years, was a form of government that was like a magnet, sucking in anything that could build on the racist foundation laid out by Hitler. Theories and policies from the past were resurrected to go alongside the growing power of the nation. A perfect nation was their goal. With Hitler leading the National Socialists, or Nazis, with his astonishing political skills, they adopted symbols from the past and made policies to turn Germany into a National Socialist country.

* good section intro

Some people ask, "How did such an evil empire come to be?" The answer is simple. Germany needed a leader and Hitler was the best leader Germany had. His persuasive, manipulative speeches and his promises for a great nation were enough to get almost the entire German community to strongly support him (Nyomarkey 12). The Germans wanted something to be proud of, and Hitler was able to provide it for

them. With Hitler saying things like, "The common interest before self interest," and "Love Germany more than anything, and your fellow Germans more than yourself!" the German people felt like they were part of something special and exciting (Remak 39). His orders, whether written or oral, "cancelled all written law" (Nyomarkey 12). The German people accepted this and loved their leader. They were glad to see Germany being brought out of the economic depression it was in. Germany, under the Nazi regime, was overcoming the effects of the great depression (Remak 75). This boosted the community's moral. Hitler got the Germans moving again and gave them something to strive for. A certain energy, "...a feeling that things were moving again, that a new energy had been infused into German life," as described by one citizen, was moving through Germany (Remak 71). A new social structure was being formed, with Hitler and his ideas at the top.

good concept

The Nazis used several ancient runes in their flags and military signs, along with special code words used by officers. The swastika itself, a symbol now imbedded into many minds as a symbol of evil, was derived from an ancient rune known as a *Hakenkreuz*. It was a pagan Germanic symbol of the god of thunder known as Donnor or Thor ("History"). Its red background indicated the "social idea of the movement," and the white circle indicated its "nationalism" (Thornton 25). The Nazi's "SS" symbol was also an ancient pagan rune, known as a *sig-rune*. By itself the sig-rune was only one large lightning bolt-type "S" which symbolized victory ("History"). A badge manufacturer, who just put two of the *sig-runes* together, invented the "SS" symbol. Code words, such as Aktion T4 and KZ were used often by Nazi officers. Aktion T4 was the code name of the euthanasia program

really? I didn't know there was a connection

this is interesting

that led to the killing of approximately 100,000 lives that were “not worth living.” Aktion T4 was named after the relevant government department of the Reich chancellery located on Tiergarten Strasse 4 in Berlin (“History”). KZ stood for Konzentrationslager, which means concentration camp. It was used constantly by Nazi officers and soldiers to somewhat lessen the idea of the camps, and what they were used for (“History”). The Third Reich was definitely a unique government, using symbols from ancient pagan runes and coming up with entirely new and extremely racist laws.

Racism was rooted into the Nazi government just like freedom is rooted in America’s government. Laws for censorship, foreigners, and duties of citizens were all intended to protect the state. Hitler once stated that “We have to put a stop to the idea that it is a part of everybody’s civil rights to say what he pleases” (Remak 83). Strong censorship was imposed in Germany against books, articles, magazines, films, and even art. Nazi rulers had complete control over what they wanted their citizens to see, hear, and read. They indeed “...had a free hand to determine[,] if it could, every man’s attitude toward life,” (Moose xxi). Euthanasia is a current topic in today’s American society, but in Nazi Germany, all mentally disabled people or “incurable mental defectives” were killed due to the Aktion T4 project (Thornton 28). A citizen had strict duties and at the top of their list was working for the good of the state (Thornton 24). Aliens, on the other hand, were to be discriminated against. The German people wanted only pure Germans in their country. Any others were to be “disposed of.” Therefore, foreigners had few rights, and Jews in particular were to be

instead
use (sic)
to show
there was
an error
in the
original

quotes?
where's the context?

hated (Thornton 24). The concepts of racial superiority, national community, and leadership were most popular in the Nazi's *weltshauung*, or world view.

Hitler made almost everyone in Germany have a sense of national pride. Policies were made to strengthen the pride and weaken resistance. Strong propaganda techniques using intimidating symbols allowed the Nazis to rule in Germany. With Hitler's ideas and the racism involved in the Third Reich, the killing of millions of people from "inferior races" was deemed necessary. The number of deaths the Nazis are responsible for will never be known ^{C.S.} however it is believed that from the concentration camps alone, over eleven million people lost their lives. The Third Reich almost completely wiped out the Jewish population in Europe in the late 1930's and early 1940's. ~~Now~~ in our minds, that is utterly inhumane, immoral, and evil, but in the Nazi's minds, it was perfectly fine to exterminate an entire race. The majority of the world's population considers the Nazis evil because of the concentration camps and the treatment of the Jewish race. *incredible*

The Nazis had a distinct hatred for the Jewish race. They wanted the entire race exterminated and the most efficient way of doing this was to make concentration camps. Nazi doctors controlled life and death in most of the concentration camps. Prisoners considered one doctor, Joseph Mengele, as "... a non-human, evil force... the lord of life and death" (Lifton 345). The wife of a high-ranking Nazi officer near Buchenwald was known to have collected "lampshades, book covers, and gloves made of human skin from murdered concentration camp inmates" (Infield 75). *why? why strike out Jews*
yuk

In the earlier years, shootings were the more "popular" way of disposing of Jews. The shootings were very secret though, and since almost all "shootings took place beyond

Germany's borders," it was easier to keep shootings out of the news (Remak 154). Sometimes twisted Nazi officers would line up prisoners and fire a rifle round into the first just to see how many chests it would go through. As time passed, gas chambers and crematoriums became responsible for most of the killing. An SS guard once said, "the killing way easy...they just went in expecting to take showers and instead of water we turned on poison gas" (Infield 76). Gassing was indeed the most efficient method. Because of "...occasional emotional difficulties encountered by the executioners, who might balk at shooting children, for instance, gassing proved by far the most efficient method," (Remak 158), says an SS guard in regards to gas chambers. Methods of killing did vary. In a city called Riga, convicts were released, given iron bars, and ordered to kill Jews (Remak 152). The hatred was constantly reinforced through speeches from people like Hitler and Himmler. Himmler once said "whether or not 10,000 Russian women collapse from exhaustion while digging... interests me only in so far as the ditch is completed for Germany," ("History") which implies that all he cares for, and all he wants everyone else in Germany to care for, is Germany. Millions of people died as a result of the concentration camps.

good quote usage
Wow - I've never heard this one before

The amount of hatred for the Jewish race was incredible. The Nazi's hatred "was symbolized for them by the Jews," who very often became targets, scapegoats, and the usual suspects (Thornton 10). Nazis constantly insulted the Jewish race. They were not even regarded as human beings, only "an appearance of putrescence" (Moose 336). It helped them to build the hatred for the Jews. Public speeches like "the Jew is... a parasite, a sponger... a pernicious bacillus... his presence is also like

that of a vampire; for whenever he established himself [.] the people... are bound to be bled to death..." (Thornton 10) were also used to boost the hatred in Germany. It was all part of their beliefs and they saw nothing wrong with it. "The inhuman persecution of the Jews that the Nazis carried out was firmly based on their view of life," and therefore, in their own minds, killing was right (Thornton 5). In order to maintain their government, the Jewish race had to be forced out of the picture.

Many people today have a hard time picturing the overall impact of the concentration camps. One of the largest goals of the Third Reich was to destroy the Jewish race, and they almost did. The Nazis killed approximately six million Jews using gas chambers and firing squads. While the "inferior" Jewish race was being exterminated, the "superior" Aryan race was striving to become stronger workers and families. Family values in Nazi Germany were very strong. Germans wanted to keep their families strong, healthy, and active. Education was revised, the woman's role was changed, and the overall Aryan racial elements were outlined in order to have a more perfect, flawless community.

good transcription

Education was not made to benefit the individual, but to benefit the state. It was very important for Hitler's youth. He wanted the highest task of education to be the preservation, care, and development of the best racial elements (Pine 1). It was also used to make a more perfect generation of Germans, who were strong and prepared to sacrifice and undertake responsibilities towards [?] the nation community (Pine 1). In order to do this, textbooks and schools were reformed. Nazi symbols were often used within domestic themes in order to make them "familiar and more accessible to children" (Pine 2). Swastikas were inserted into books, pictures of

Hitler with children were posted in schools, and eventually school children were putting swastikas in their homes (Pine 2). Scientific and arithmetic examples in textbooks also helped the youth with their racial superiority education. Craniology, the study of the skull, was used to distinguish the "inferior" races from the "superior" races (Pine 4). Arithmetic was used to show how "wasteful" the mentally challenged were and how much money could be saved by euthanasia (Pine 5). These ideas were then transferred to German homes where parents could learn about their roles in the Third Reich.

wow - this is scary. we are very susceptible as a species.

don't transition here

The woman's role, in particular, was very unique. Throughout time women have tried to be treated as equals to males. Eventually they did win their rights in America, but in Nazi Germany, the women were supposed to be "glad" to stay home and cook and clean all day long. They were to be "beautiful and to bring children into the world" (Moose 41). It was said that motherhood was in the "front rank of patriotic as well as moral virtues" (Schoenbaum 188). Women were required to raise the children, cook, clean, and look after the house. It was also "good morals for a woman to have several children" (Moose 37). However, they were still discriminated against. Women who had "many miscarriages, or who brought deformed, sick, or sickly children into the world" were considered inferior (Moose 37). They could not join in politics nor serve in the armed forces. This was all part of the "superior" Aryan race and was considered to be the law.

increases pop.

don't transition at end of Ps

how about reintergrating?

Those of the Aryan race considered themselves to be members of the superior human race. All others were inferior and were constantly criticized. Extreme racism was used to show the Nazi's superiority. The personal characteristics of the Aryan

race included honor, courage, love of freedom, and a strong spirit of scientific research (Thornton 5). Physically, the Aryans were tall, strong, and long-headed. They had blue eyes and blond hair, with a fair skin complexion (Thornton 5). Many attempts were made to increase the "pure" German blood population, such as stealing children who matched the physical requirements of the Aryan race from their homes. Himmler once responded to a question that asked "How can we be so cruel as to take a child from its mother," by saying "How much more cruel [is it] to leave a potential genius with our natural enemy?" (Infield 138). The Nazis were very determined in forming a perfect German nation.

Breeding became a controlled issue in the Third Reich. Only the elite would reproduce (Pine 1). It became against the law for a pure German person to breed with someone who was not. The goal was to bring together a high-grade heredity stock and to eliminate all inferior races from the German people (Moose 35). They believed that because of inferior races, like the Jews, many true German families were ruined by the result of only one "low-grade" person coming into the family. Once again, it was the Jews' fault for Germany's problems.

Family values in Germany were strengthened during the Third Reich. Education, along with the woman's role, was reformed according to Nazi beliefs. The Aryan race and breeding guidelines were also outlined as a result of new policies. Despite these reforms and new policies, the Nazi regime was defeated. Most of the leaders fought until the end, turning out new plans for the Third Reich. Hitler had many plans for his nation and the world that he would never see accomplished.

Hitler's main goals were to conquer Europe and form a perfect Aryan nation. A nation would be created that would thrive on National Socialism. Hitler wanted leaders, but he also wanted all of his citizens to feel equal. "No one should think himself superior to his fellow man" and even leaders should be "devoted to service and responsibilities" (Moose xxxvii). He was afraid that "intellectuals would feel superior to others because of their knowledge and thus form a separate group within the people which would be difficult to control" (Moose xxxvii). As Americans, we consider the freedom of the press as a right. Nazis, on the other hand, only allowed the freedom of the press to be permitted "within a framework conducive to the national welfare" (Thornton 24). A "strict censorship" was also placed on the publishing industry (Pine 1). Hitler wanted the people of his nation only to see what he wanted them to see, in order to have them remain loyal to the Third Reich.

Hitler had plans for Europe, as well as the world. A theory the Nazis believed was that "if youth could be captured by their world view, the future was assured" (Moose xxxii). This means the youth of the world would grow up believing in Nazism whether living in Germany or not. A large plan of Hitler's was to conquer Russia and use the land for farming and for more Germans to live on. There were going to be several "population transfers" (Remak 127) in Europe and Asia, because space was needed for the German people. Space was to be made in several ways, such as "low rations, shootings, an expulsions" (Remak 122). The people would be able to live free, just as long as the Germans were their rulers. In case of a revolution, they would "drop a few bombs on their cities and the affair will be over" (Remak 128). Judaism was also to be "destroyed" since they believed it posed an

international threat to Germany (Smith 255). This would allow more room for the German people and exterminate the main "inferior" race in Europe. Those types of events show the care, or lack thereof, for the people of other nations besides Germany. Eventually, if Hitler had won the war, the Third Reich would have spanned over the whole globe and tens of millions or more people would have been eliminated.

Scary thought

The Third Reich, at its prime, posed a great threat to the well being of all of the European nations and indeed the whole world. Germany would have been a nation in which all citizens were equal, at least all of the Aryan citizens, and anyone who opposed the Nazis would be killed. Nearby lands would have been conquered and the Jewish population would have been even more diminished. Millions more people would have been killed as a result of the "population transfers" the Germans had in store for their conquered territories.

The Third Reich, led by Adolf Hitler, was one of the most evil and racist forms of government ever. The goals of the Third Reich were to make a perfect Aryan nation, destroy the inferior races, and conquer enough land to accommodate the German people. After Hitler came to power he reformed laws, policies, and family values, and set goals for the future of his nation. Reformations of education and of laws allowed the Third Reich to carry on for years. The concentration camps killed millions. The racist views brainwashed the society into believing the Aryans were superior to all other races. They were responsible for the deaths of at least eleven million people. These things were all part of Hitler's master plan of creating a perfect Aryan race to rule Germany.

abit too repetitive

Works Cited

"History." Online. Available: ↗

(it's ok to split the address line)

<http://www.geocities.com/Vienna/Strasse/8514/history.html>. 25 October 1998.

Infield, Glenn B. Secrets of the SS. Stein and Day. Braircliff Manor, NY. 1981.

Lifton, Robert Jay. The Nazi Doctors. Robert Jay Lifton, 1986.

Moose, George L. Nazi Culture. New York: Grosset and Dunlap, 1966.

Nyomarkay. The Nazi Party. University of Minnesota, 1967.

Pine, Lisa. "Nazism in the Classroom". History Today April 1997: 22-28.

Remak, Joseph. The Nazi Years. Prentice-Hall Inc. Englewood Cliffs, NJ. 1969.

Schoenbaum, David. Hitler's Social Revolution. Doubleday Company, Inc., Garden City, New York, 1966.

Smith, Woodruff D. The Ideological Origins of Nazi Imperialism. New York: Oxford University Press, 1986.

Thornton, M. J. Nazism. Pergamon Press Ltd., 1966.



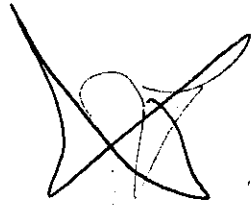

K W A F D

12g.
Browning cutoff 5/s crack shotgun : 300 pellet 12g. shells
Uzi 9mm, short barrel : 10 35 rd. ~~mag.~~ mags.
(2) Calico Liberty III 9m semi-auto 4 100rd. clips
Wilkey .45 magnum semi-auto 30 12rd. clips

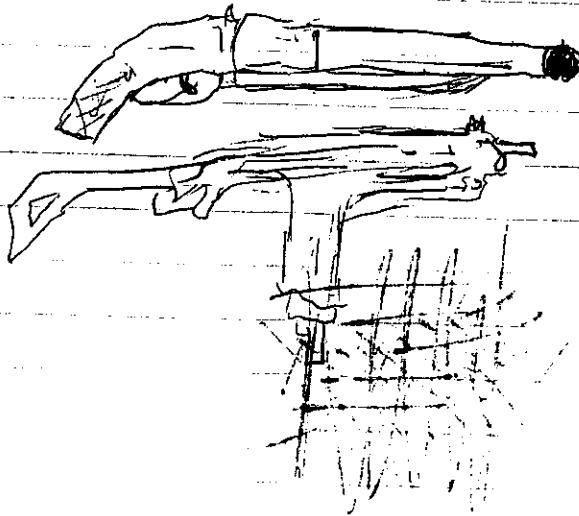

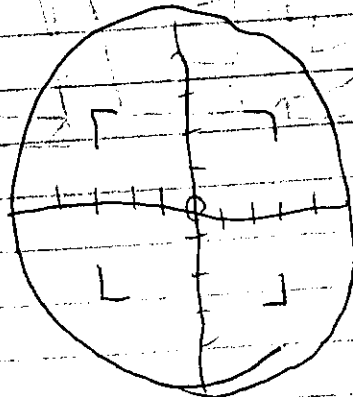
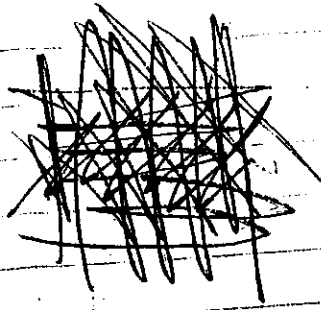

where is she

forever I will wait for,
need her, love her, be with
her, (search for me) which gets

Godness pain,
eternal denial is known
when she doesn't love me...

inspiring



Sorry



Sadness
NIN
X

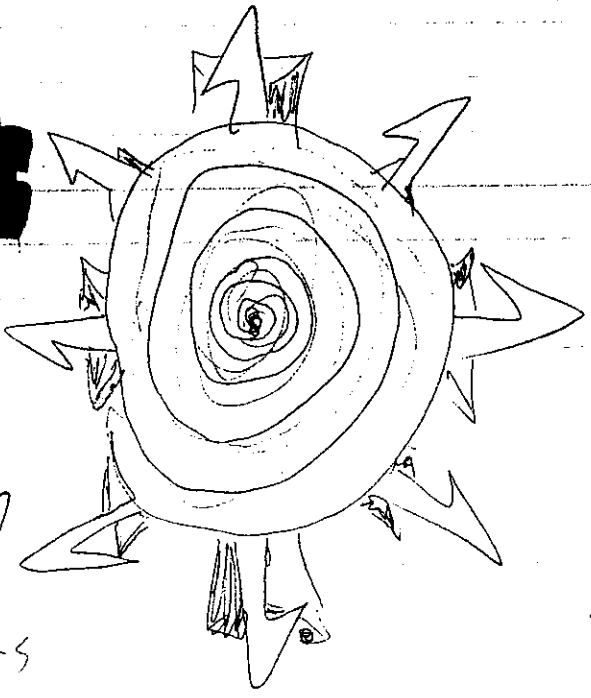

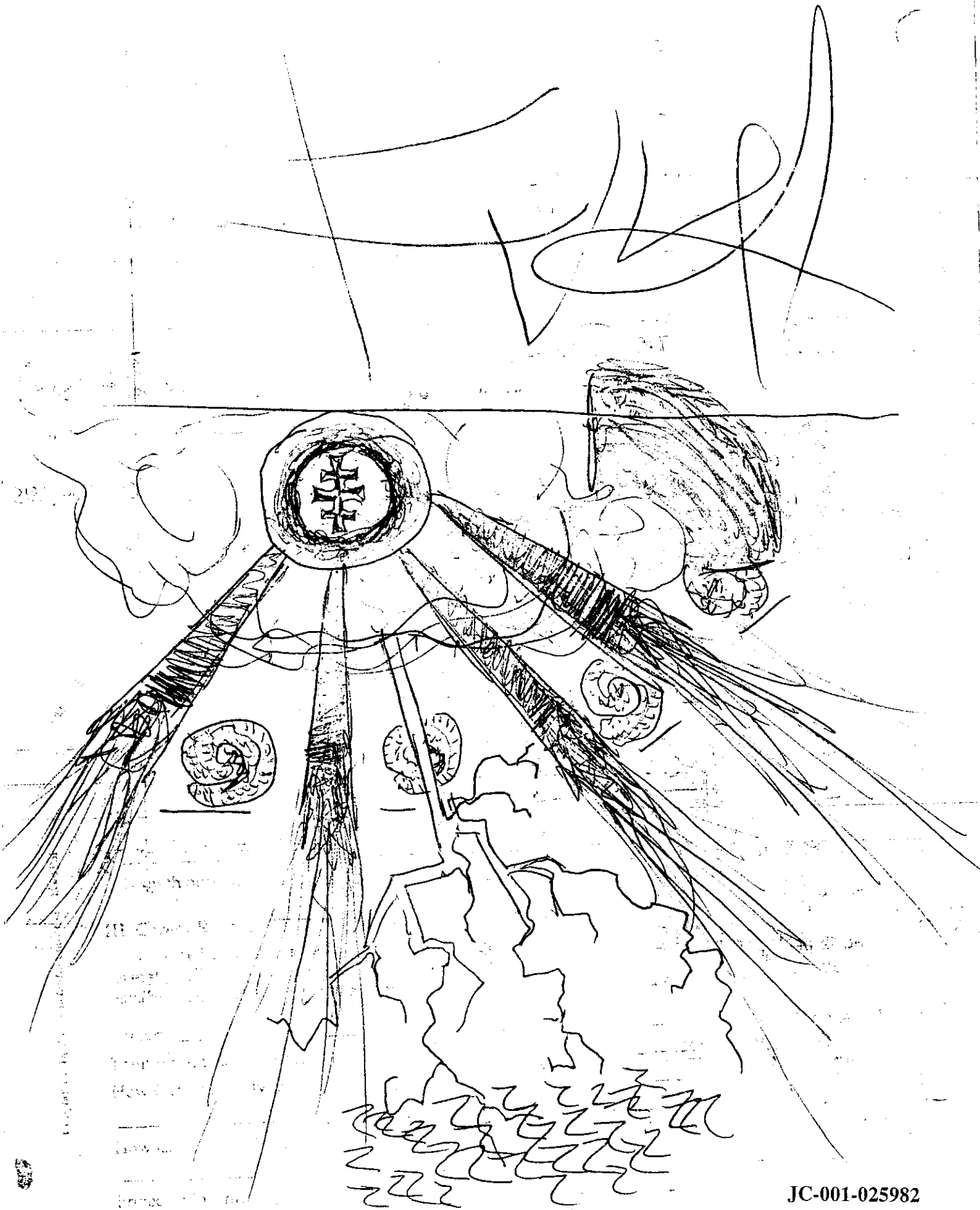

Research Paper

- Pick a Topic: interests, ^{you} & available
- avoid overused topics.
 - do something ~~that~~ that you can find something on
 - needs intellectual importance.
 - objective, not subjective.

Narrow the Topic

Limit to part of life, one section, one belief (some)

Possible:

"The minds and motives of Charles Manson and other serial killers"

Before notes, make outline - editable ~~copy~~ copy.

what are the most important ideas

what are the questions you ask

what is background info necessary

what are the points, how do they relate

- advantageous to create an outline revise it later

take notes off the outline's guidelines

Notes: 2 types: works cited card, note cards

Book

Mamma, Jo Fat. Wheat Thicks were Fater
Nigeria: Eggrolling Books, 1991.

#2

all
note
cards
w. that
num.

Mag

Mamma, Jo. "old money is owed to Moses"
Stick Choppers Quarterly Feb 1990. 12+

#3

Int

"Title of Niggaz." On-line. Available: www.Fuckheads.com
9 September 1999.

Date of find

JC-001-025983

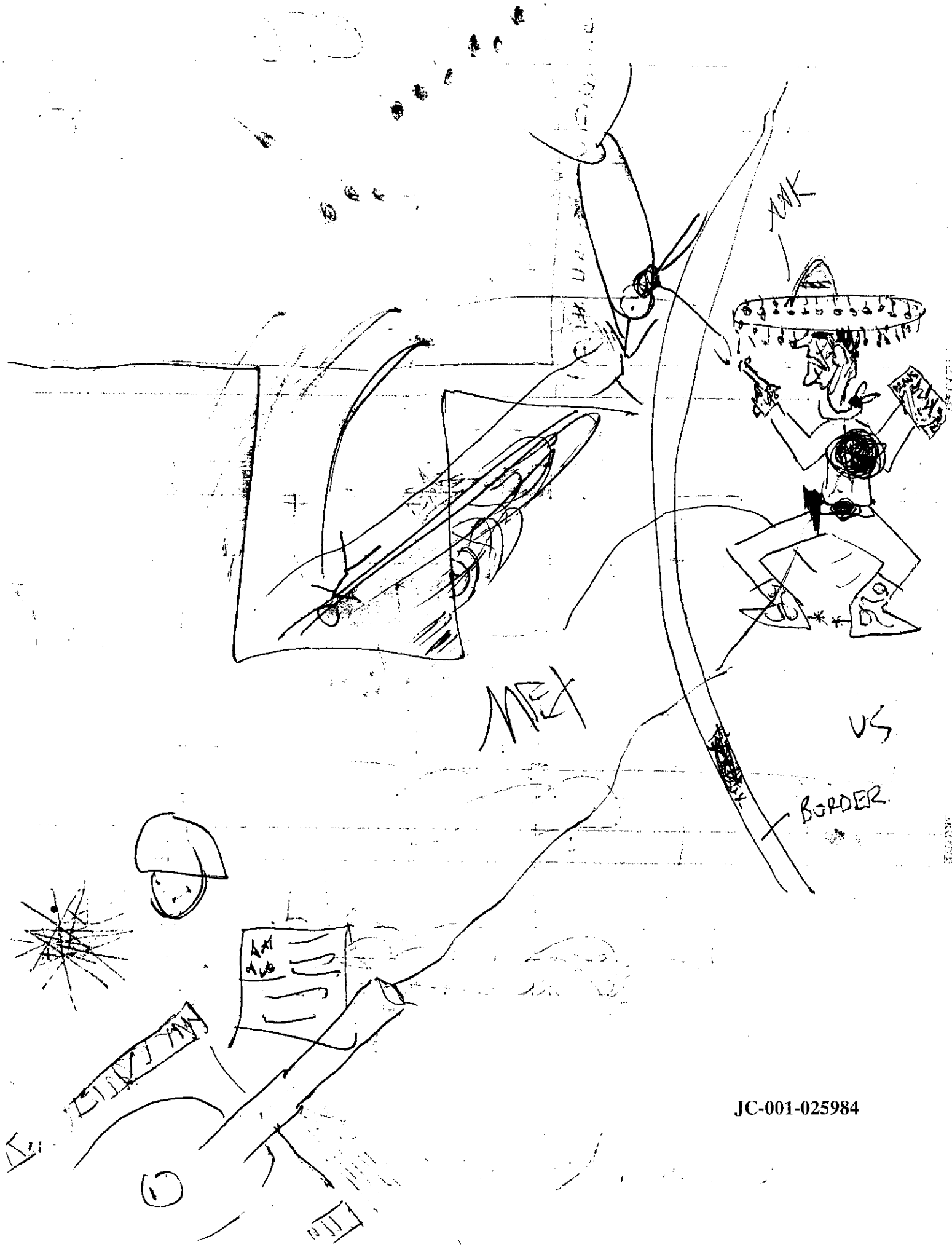

JC-001-025984

Handwritten text at the top of the page, possibly a name or title, written in a cursive style.

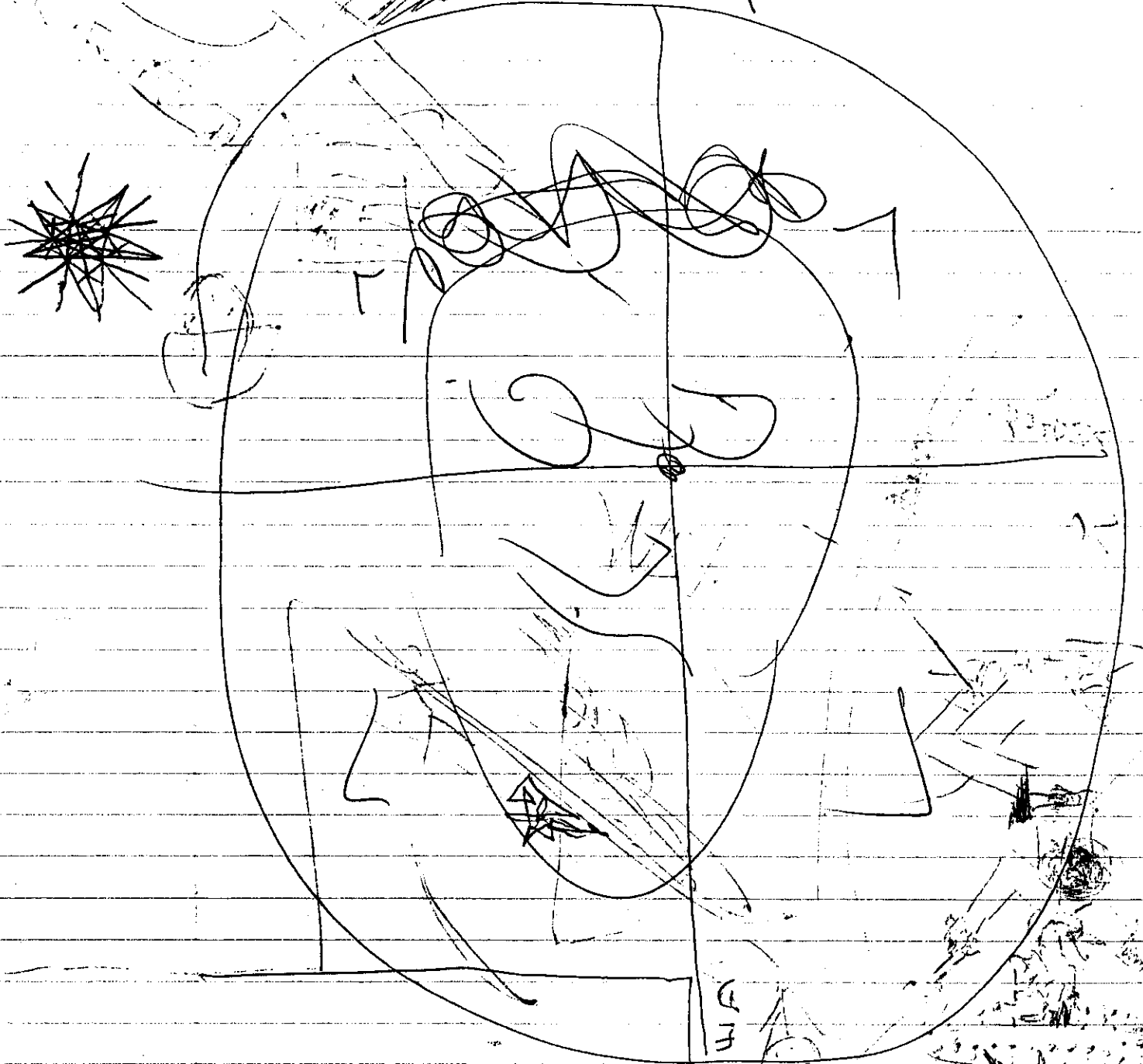

Handwritten notes and symbols at the bottom left of the page, including a large '9' and several small, dark, irregular shapes.

Vertical handwritten text on the right side of the page, possibly a list or index of items.

Dylan
Eric Harris

[REDACTED]

Fried
Fried
Fried

[REDACTED]

desks - wood, metal

fr - manufacturing parts

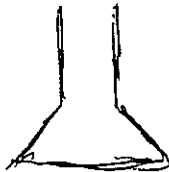

JC-001-025987

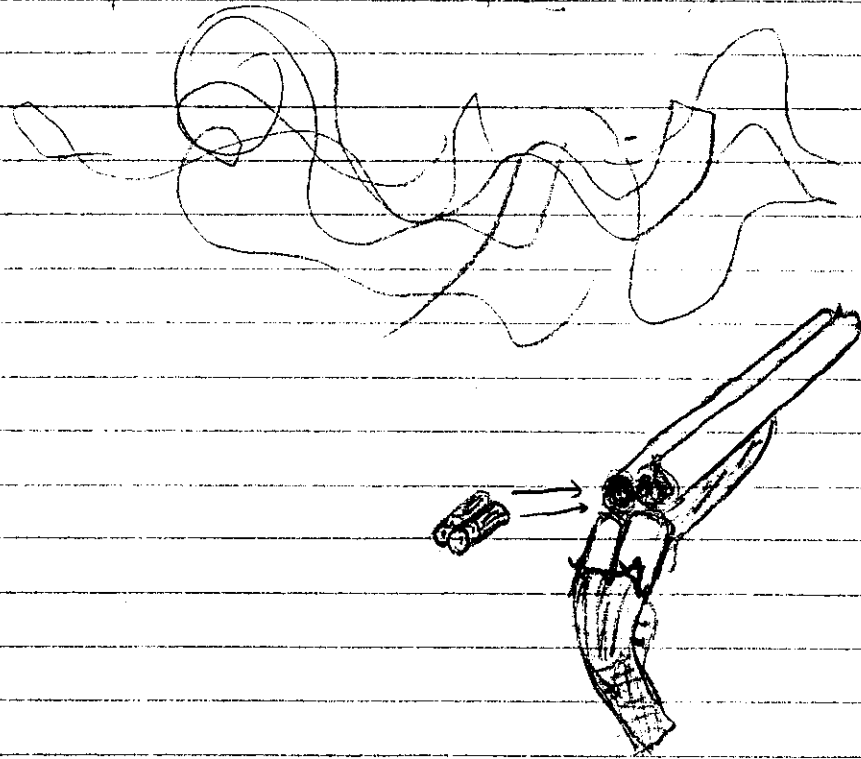

JC-001-025988

Ctg
AOL
Puffy

AOL
Haxor

~~boom~~
~~haxor~~

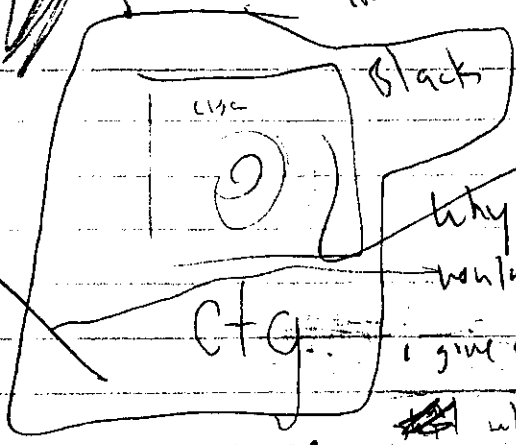
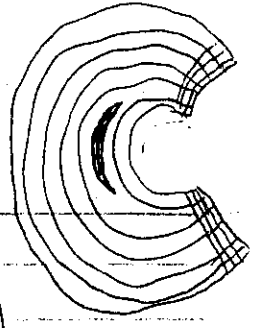

why
would
i give a

~~what~~
fxxk Jesus would
do???

Shit
Gj
The client
Bools



~~haxor~~

DR. Green,
AOL: white text
WHERE KEWLz
Haxorz ARE
Aollet
D dood!
Puffy

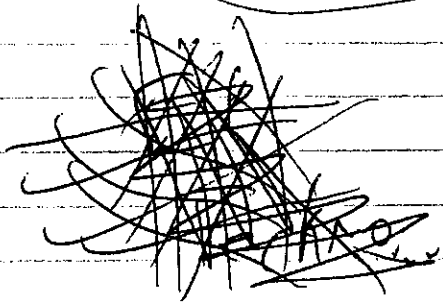
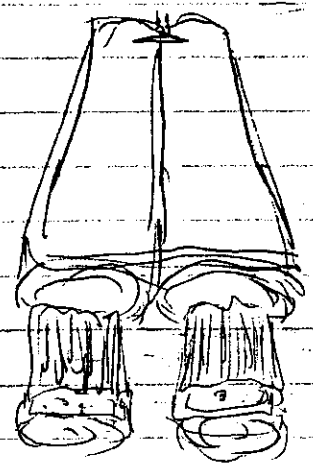

AOLlet

Mamma
so.....

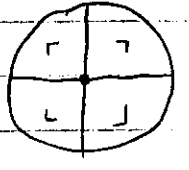
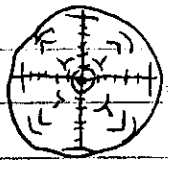

--VooDooMFA

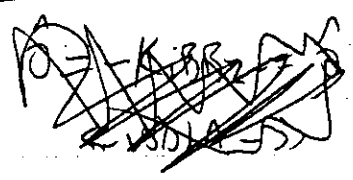

The true
haxor

AOL:
WHERE ~~ARE~~
KEWLz Haxorz
~~ARE~~
stay

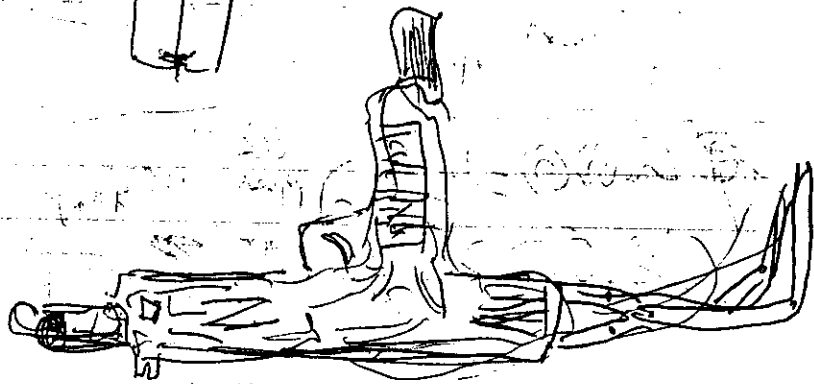
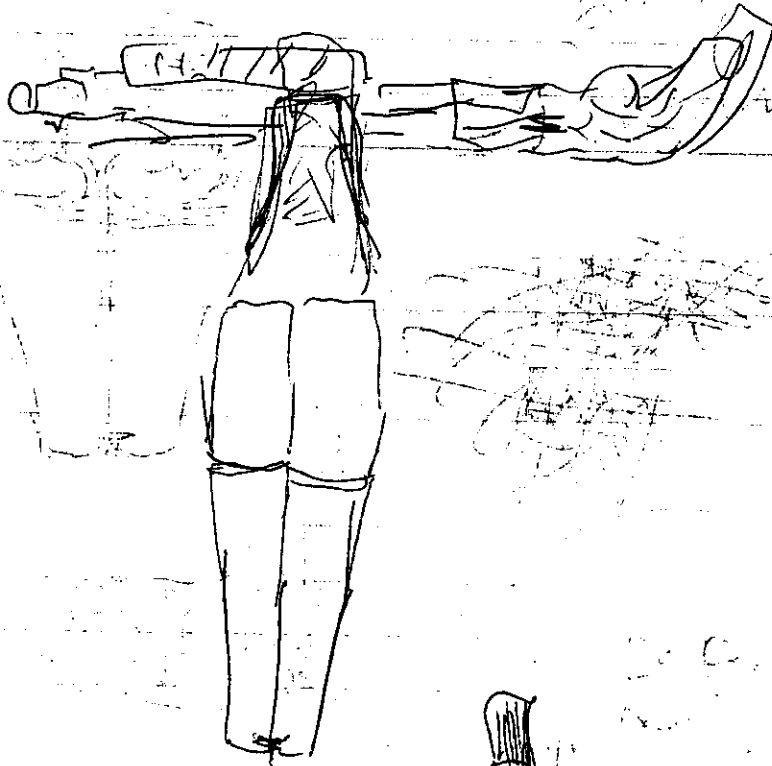

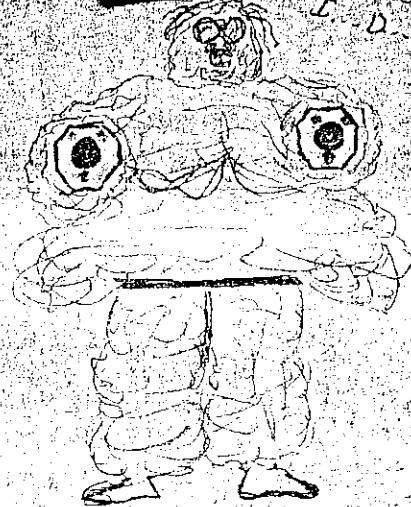
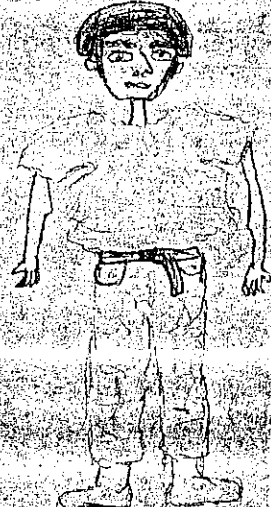
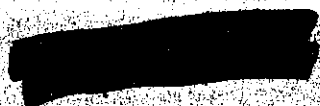
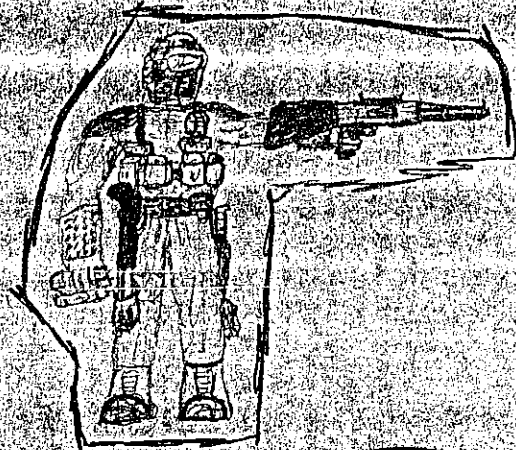

Simone de la
I. D. CARDU

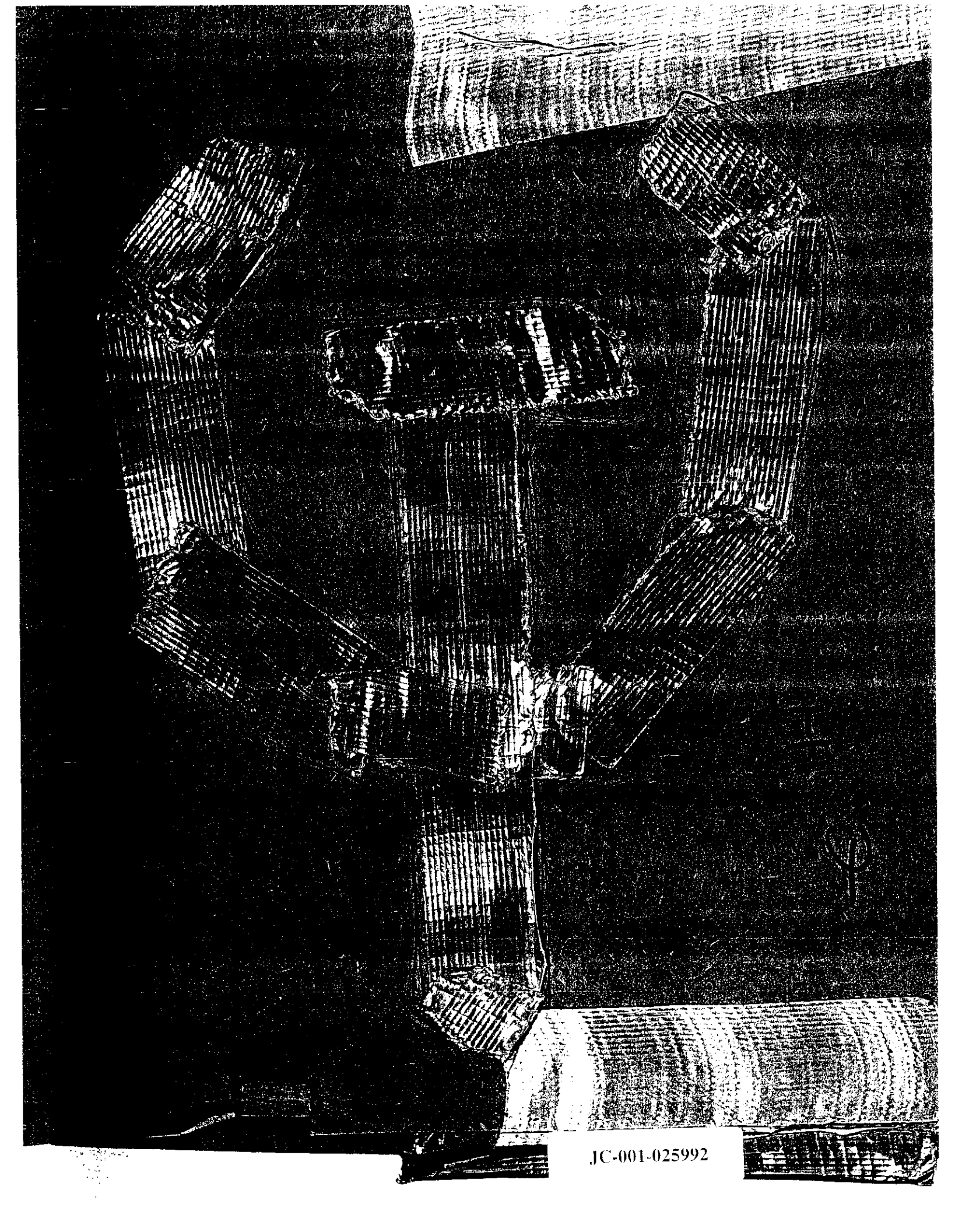

JC-001-025992

AFTER SCHOOL PLANNING
 4 5 6 7 8 9

ASSIGNMENTS
 4 5 6 7 8 9

BANG

BANG

4 5 6 7 8 9

optimism

Your outlook determines your ability to overcome any challenge.
Stay positive and focus on solutions, not problems.

optimism 204h → 11:10

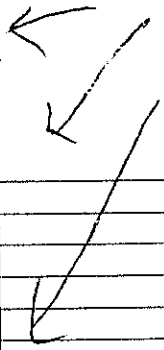
	THURSDAY	FRIDAY	SATURDAY
make TODAY count	13 Death (Afraid?)	14 Get nails Get gas cans Get duffel bags Get propane Fill my clips	15 Armed Forces Day
		finish fuses finish crickets finish T-bombs Get → in BPs Fill gas cans Get PBs in BPs	
ASSIGNMENTS			SUNDAY
			16
AFTER SCHOOL PLANNING	4 5 6 7 8 9	4 5 6 7 8 9	

SUNDAY

9

Mother's Day

4 5 6 7 8 9

* if put gas
tanks in crawl
space or garage
somewhere
empty

I ~~to~~ The ~~gun~~ ~~AA~~ ~~AA~~ ~~AA~~
 5! 10 2 spots

I am A gun. A Willey 45 semiautomatic. I am god.

I kill people I was never made for hunting just
 to kill humans. When someone needs to die, I kill them.

There was this bald guy once. He was gay &
 arrogant & superficial & had ~~power~~
 a false sense of power. I blew off half his head
 with 1 shot. I am god. He died.

~~BLACK~~ BLACK

I am purity, Darkness, Romanticism, Professionalism,
 Existence, Complacency, Power, Pain. Everything is
 black. I am everything.

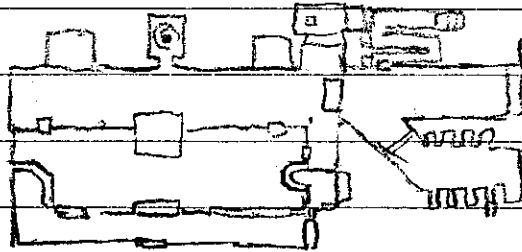
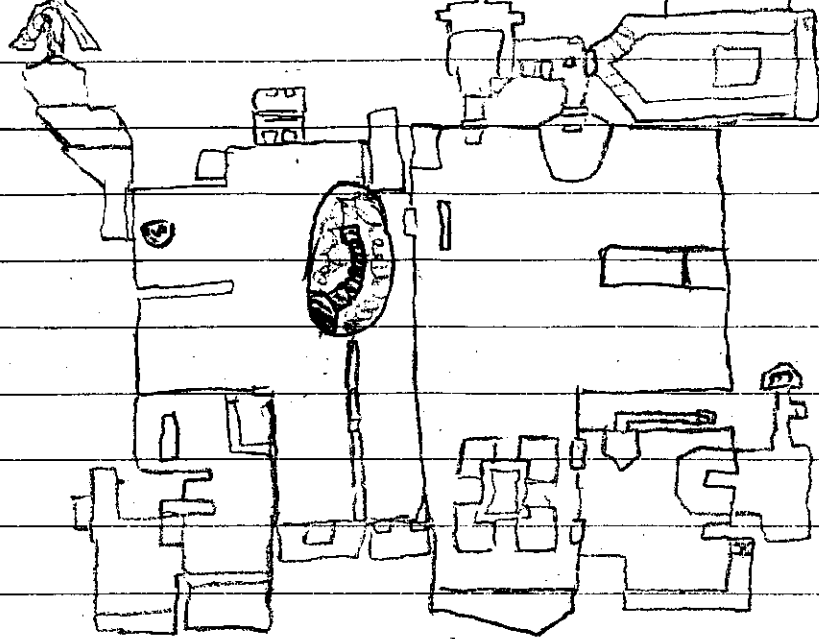
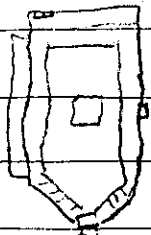

JC-001-025997

The document described below
has been removed

Description of Document: The Anarchist
Cookbook, "Chart of Household
Substitutes for Chemicals"

Date of Document: N/A

Reason for Removal

- Copyright
- Bomb-making instructions
- Medical Records
- Other

Comments: _____

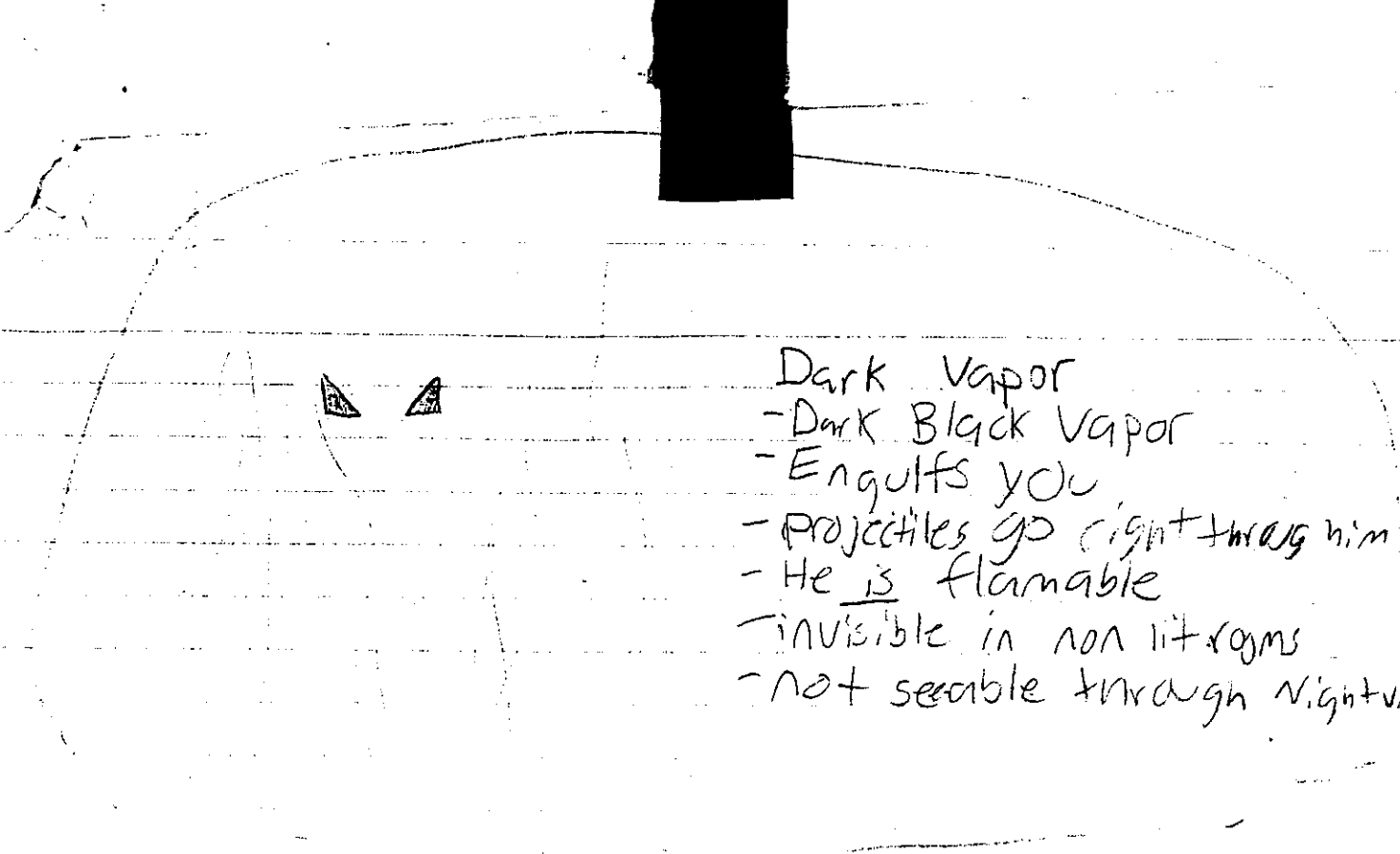
- 
- Dark Vapor
- Dark Black Vapor
 - Engulfs you
 - Projectiles go right through him
 - He is flammable
 - invisible in non lit rooms
 - not seeable through night vision

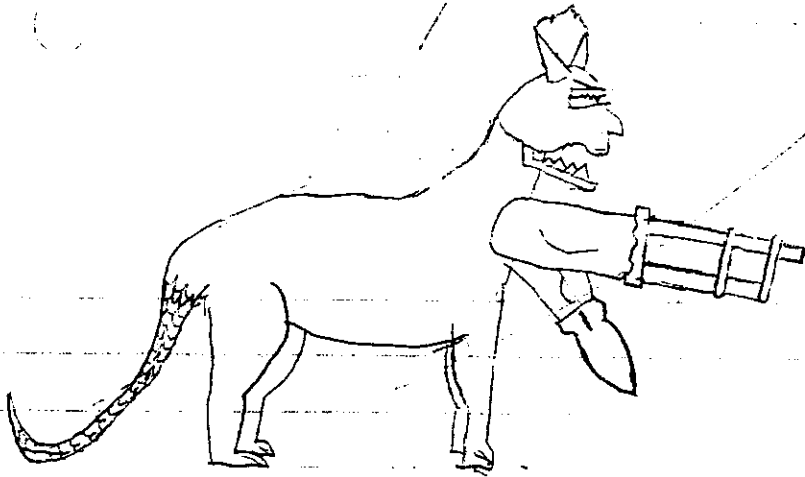

- Hell Dog
- Chain gun for hand
 - Rocket for other that regenerates
 - Flesh ripping jaws
 - Electric charge from spikes on head

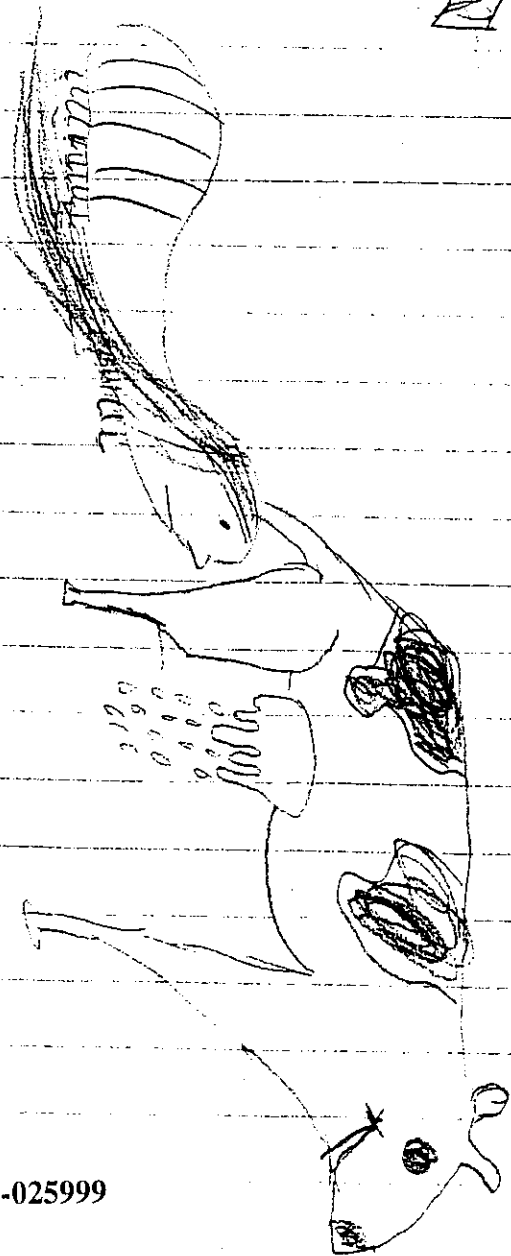
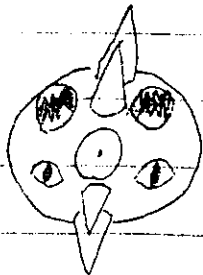
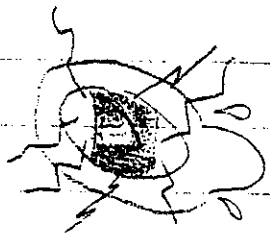
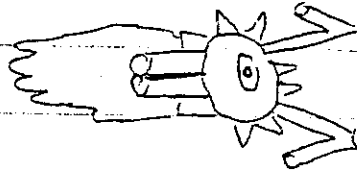
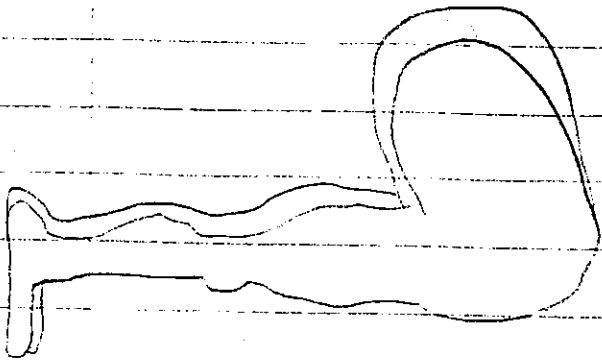

subject organizer

Wald THE
DAS WERE
IN FLAMMEN
STHEN?



TEST DATE	TEST SCORE	ASSIGNMENT	DUE DATE	ASSIGNMENT	DUE DATE

Use what you need. Save what you can.

NOTES:



CLASS SCHEDULE

TIME:					
Monday					
Tuesday					
Wednesday					
Thursday					
Friday					
Saturday					

Please return to:

My NAME REB

& Address REB



Telephone Numbers

Name and Number	Name and Number	Name and Number

Important Dates

Metric Conversions

LENGTH

millimeter	(mm)	0.04 inch
centimeter	(cm)	0.39 inch
decimeter	(dm)	3.94 inches
meter	(m)	39.37 inches

WEIGHT

milligram	(mg)	0.015 grain
centigram	(cg)	0.154 grain
decigram	(dg)	1.543 grains
gram	(g)	0.035 ounce
dekagram	(dag)	0.353 ounce
hectogram	(hg)	3.527 ounces
kilogram	(kg)	2.2046 pounds
quintal	(q)	220.46 pounds
metric ton	(t)	1.1 tons

LIQUID CAPACITY

milliliter	(ml)	0.27 fluid dram
centiliter	(cl)	0.338 fluid ounce
deciliter	(dl)	0.21 pint
liter	(l)	1.057 quarts
dekaliter	(dal)	2.64 gallons

TEMPERATURE

To convert Fahrenheit temperatures to Centigrade temperatures, subtract 32 from °F and divide by 1.8.

To convert Centigrade temperatures to Fahrenheit temperatures, multiply °C by 1.8 and add 32.

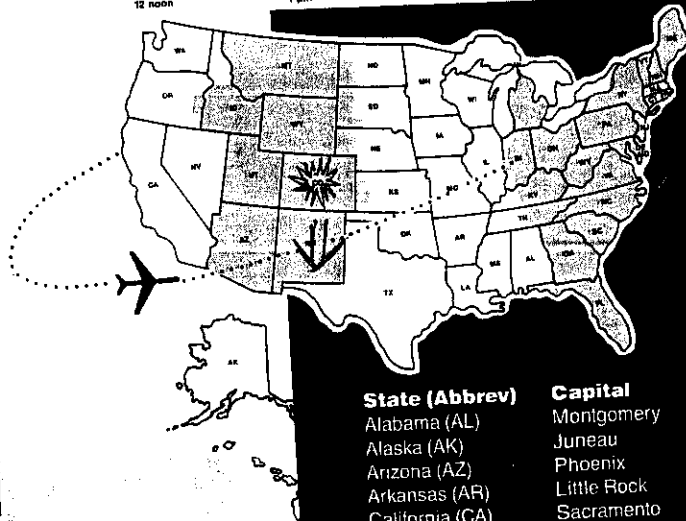

Louisiana (LA)	Baton Rouge
Maine (ME)	Augusta
Maryland (MD)	Annapolis
Massachusetts (MA)	Boston
Michigan (MI)	Lansing
Minnesota (MN)	St. Paul
Mississippi (MS)	Jackson
Missouri (MO)	Jefferson City
Montana (MT)	Helena
Nebraska (NE)	Lincoln
Nevada (NV)	Carson City
New Hampshire (NH)	Concord
New Jersey (NJ)	Trenton
New Mexico (NM)	Santa Fe
New York (NY)	Albany
North Carolina (NC)	Raleigh
North Dakota (ND)	Bismarck
Ohio (OH)	Columbus
Oklahoma (OK)	Oklahoma City
Oregon (OR)	Salem
Pennsylvania (PA)	Harrisburg
Rhode Island (RI)	Providence
South Carolina (SC)	Columbia
South Dakota (SD)	Pierre
Tennessee (TN)	Nashville
Texas (TX)	Austin
Utah (UT)	Salt Lake City
Vermont (VT)	Montpelier
Virginia (VA)	Richmond
Washington (WA)	Olympia
West Virginia (WV)	Charleston
Wisconsin (WI)	Madison
Wyoming (WY)	Cheyenne

State (Abbrev)

Alabama (AL)
Alaska (AK)
Arizona (AZ)
Arkansas (AR)
California (CA)
Colorado (CO)
Connecticut (CT)
Delaware (DE)
Florida (FL)
Georgia (GA)
Hawaii (HI)
Idaho (ID)
Illinois (IL)
Indiana (IN)
Iowa (IA)
Kansas (KS)
Kentucky (KY)

Capital

Montgomery
Juneau
Phoenix
Little Rock
Sacramento
Denver
Hartford
Dover
Tallahassee
Atlanta
Honolulu
Boise
Springfield
Indianapolis
Des Moines
Topeka
Frankfort



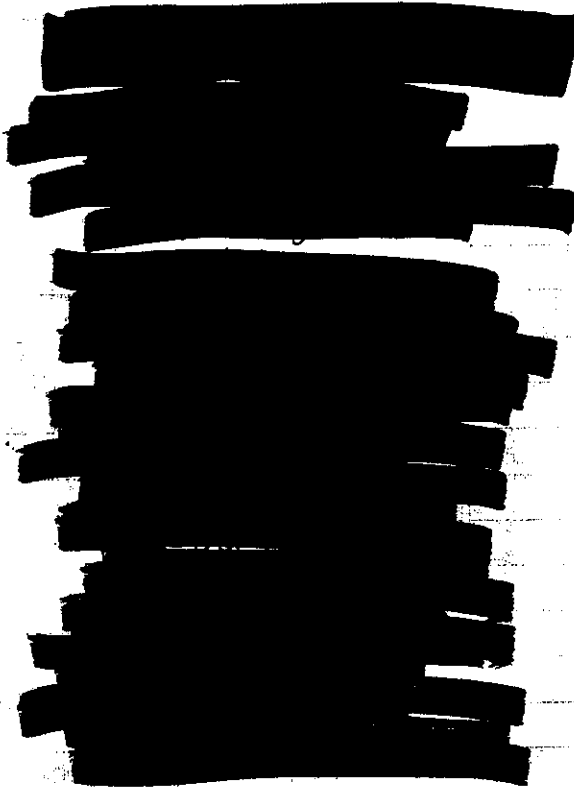

Class of 98,
top of the
"Should have died"
list.

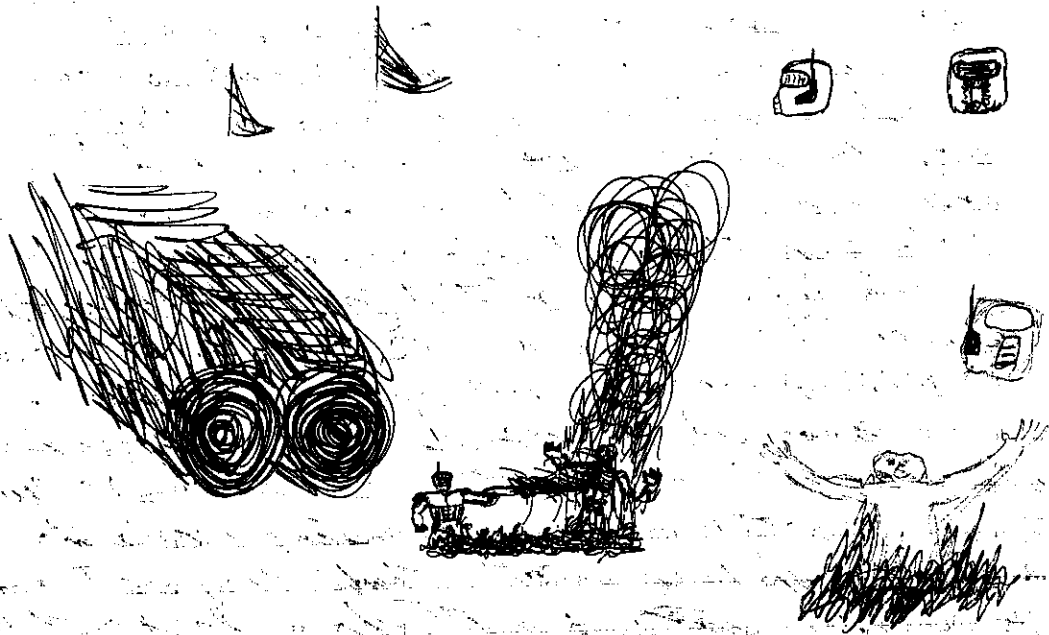

I hate this fucking world, too much
god damn fuckers in it, too many thoughts
and different societies all wrapped up together
in this fucking place called AMERICA, everyone
has their own god damn opinion on every god
damn thing, and you may be saying "well
what makes you so different?" because I have
something only me and I have, SELF AWARENESS,
call it egotism or whatever the fuck I
want, we know what we are to this world
and what everyone else is, we learn more
than what caused the civil war and how to
simplify quadratic in school, we have been
watching you people, we know what you
think and how you act, all talk and
no actions, people who are said to be
brave or courageous are usually just STUPID.
then they say later that they did it on purpose,
cause they are brave, when they did or fucked up
accident, GOD everything is so corrupt and
so filled with opinions and points of view
and people's own little agendas and schedules
there isn't a world anymore it's H.O.F. and
(one) knows it, self awareness is a

wonderful thing, I know I will die soon,
so will you and everyone else. maybe we will
be lucky and a comet will smash us back to day 1
people say it's immoral to follow others, they
say be a leader. well here is a fuckin news flash
from you stupid shits, everyone is a follower! everyone
who says they aren't followers and then dresses diff.
or acts diff. ... they got that from something they
saw on TV or in film or in life. NO ORIGINALITY, how many
JO MAMMA votes are there and how many do I think
are original and not copied. KENT. It's a fuckin filthy
place we live in. all these standards and laws and
Great Expectations (wobb) are making people into robots
even though they might "think" they aren't and try
to deny it. ~~It's~~ no matter how hard they
try NOV copy someone I still AM! except for
that fuckin piece of paper right here, and BTW.
spelling is stupid unless I say I say spell it how
it sounds, its the fuckin easiest way! hug try
this sometime, when someone tells you something
ask "why?" eventually they will be stumped and can't
answer any more. that's because they only know
what they need to know in society and school, not
real life science. they will end up saying words
= to this "because! just shut up!" people ^{that} only know
stupid facts that aren't important should be shot,
what fuckin use are they. NATURAL SELECTION.
Kill all retards, people w/ brain fuck ups, drug
addis, people who can't figure out how to use a fuckin
lighter. Geez awd! people spend millions of dollars
on saving the lives of retards, and why I don't buy
that shit I like "oh, hes my son though!" so the fuck
what's he aint normal, kill him w/ them out of his misery
he is only a waste of time and money, then people say
"but he is worth the time, he is human too" no he
isnt, if he was then he would swallow a bullet
cause he would realize what a fuckin waste and
burden he was. 4/10/95



as I said before, self awareness is a wonderful thing. I know what all you fuckers are thinking and what to do to piss you off and make you feel bad. I always try to be different, but I always end up copying someone else. I try to be a mixture of different things and styles but when I step out of myself I end up looking like them or others. **THINK** I am copying. One big fucking problem is people telling me what to fuckin do, think, say, act, and everything else. I'll do what you say IF I feel like it. But people (i.e. parents, cops, teachers) telling me what to do just makes me not want to beeping do it. That's why my fucking name is **REB!!** no one is worthy of shit unless I say they are, I feel like God and I wish I was. Having everyone being **OFFICIALLY** lower than me. I already know that I am higher than almost anyone in the fucking world in terms of universal intelligence, and here we stand in the universe compared to the rest of the UNIV. and if you think I don't know what I'm talking about then you can just "PUK DICH" and sagen mein Hund! Isn't America supposed to be the land of the free? how come, if em bree, I can't deprive a stupid fucking dumbshit from his possessions if he leaves them sitting in the front seat of his fucking van out in plain sight and in the middle of fucking nowhere on a Fri fucking day night. **NATURAL SELECTION**. fucker should be shot. same thing with all those rich snobby toddlers at my school. fuckers think they are higher than me and everyone else with all their \$ just because they were born into it? Ich denk NEIN. BTW, "sorry" is just a word. It doesn't mean SHIT to me. everyone should be put to a

test and ~~THE~~ ULTIMATE DOOM test: see who can survive
in an environment using only smart and military skills.
Put them in a doom world, no authority, no refuge, no
BS copout excuses. If you can't figure out the area
of a triangle or what "cation" means, you die!
if you can't take down a demon w/ a chainsaw or
kill a hell prince w/ a shotgun, you die! fucking
snotty rich fuckheads ~~who~~ who ~~but~~ rely
on others or on sympathy or ~~to~~ to get them through,
life should be put to this challenge, plus it would
get rid of all the fat, retarded, crippled, stupid, dumb,
ignorant, worthless people of this world, no one
is worthy of this planet, only me and who would do good,
there is just no respect for anything higher than
your fucking boss or parent; everyone should be
shot out into space and only the people I say should
be left behind. 4/12/98

ever wonder why we go to school? besides getting a so-called
education, it's not so obvious to most of you stupid fucks but
for those who think a little more and deeper you should realize
it's the societies way of turning all the young people into
good little robots and factory workers, that's why we sit
in desks in rows and go by well schedules, to get prepared
for the real world cause "that's what it's like" well god
damnit no it isn't! one thing that separates us from other animals
is the fact that we can carry on actual thoughts. so why don't
we? people go on day by day, rote shit, why can't we learn in school
how we want to, why can't we sit on desks and on shelves and put
our feet up and relax while we learn? cause that's not what
the "real world is like" well hey fuckheads, there is no such thing as an
actual "real world", it's just another word like justice, sorry, pity, religion,
faith, luck and so on. we are humans, if we don't like something we
have the fucking ability to change! but we don't, at least I don't, I would
just whine bitch throughout life but never do a goddam
thing to change anything. "man can eat, drink, fuck, and hunt and
anything else he does is madness" - Based on Lem's quote. boy oh fuckin boy
is that true, when I go NPK, and people say things like, "oh it was so
tragic," or "oh he is crazy!" or "fo was so bloody!" I think so the fuck what, you,

think that's a bad thing? just because your mommy and
daddy told you blood and violence is bad, you think it's a
fucking law of nature? wrong, only science and math are true,
everything, and I mean every fucking thing else is Man made.
my doctor wants to put me on medication to stop thinking
about so many things and to stop ~~being~~ angry. well, I
think that anyone who doesn't think like me is just
bullshitting themselves. try it sometime if you think
you are worthy, which you probably will you little white,
drop all your beliefs and ideas and ideas that ~~you~~ have
been burned into your head and try to think about why
you're here, but I bet most of you fuckers can't even think
that deep, so that is why you must die. how dare you
think that I and you are part of the same species when
we are soooooo different. you aren't human, you are a Robot.
you don't take advantage of your ~~to~~ capabilities given to you
at birth, you just drop them and hop onto the boat and head down
the stream of life with all the other fuckers of your type.
well god damnit I won't be a part of it! I have thought
to much, realized to much, found out to much, and I am
to self aware to just stop what I am thinking and go
back to society because what I do and think isn't "right" or
"morally accepted" NO, NO, NO. God Fucking damnit NO!
I will sooner die than betray my own thoughts. but before
I leave this worthless place, I will kill who ever I deem
unfit for anything at all, especially life. and if you pissed
me off in the past, you will die if I see you. because you
might be able to piss off others and have it, eventually
all blow over, but not me. I don't forget people who wronged
me, like ~~_____~~ he will never get a chance
to read this because he will be dead ~~by~~ by me before
this is discovered. — 4/21/98

The human race sucks. human nature is smothered out
by society, jobs, and work and school. instincts are deleted
by laws. I see people say things that contradict themselves,
or people that don't take any advantage to the gift of human
life. they waste their minds on memorizing the stats of every
college basketball player or how many words should be
in a report when they should be using their brain on

more important things. The human race isn't worth fighting for anymore. WWII was the last war worth fighting and was the last time human life and human brains did any good any made us proud. now, with the government having scandals and conspiracies all over the fucking place and lying to everyone all the time and with worthless pointless mindless disgraceful TV shows on ~~the~~ and with everyone obsessed with hollywood and beauty and fame and glamour and politics and anything famous, people just aren't worth saving. Society may not realize what is happening but I know, you go to school, to get used to studying ~~the~~ and learning how you "supposed to" so that drains or filters out a little bit of human nature. but that's after your parents taught you what's right and wrong even though you may think differently, you still must follow the rules. after school you are expected to get a job or go to college, to ~~be~~ have more of your human nature blown out your ass. society tries to make everyone act the same by burying all human nature and instincts. that's what school, laws, jobs, and parents do. if they realize it or not and then, the few who stick to their natural instincts are casted out as psychos or lunatics or strangers or just plain different. crazy, strange, weird, wild, these words are not bad or degrading. if humans were let to live how we would naturally, it would be chaos and anarchy and the human race wouldn't probably last that long, but hey guess what, that's how it's supposed to be!!!! society and government are only created to have order and calmness, which is exactly the opposite of pure human nature. take away all your laws and morals and just see what you can do. if the government was one entity it would be thinking "hey, lets make some order here and calm these crazy fucks down so we can be constructive and fight other governments in our own little so called self created "civilized world" and get rid of all those damn instincts everyone has!" well shit I'm too tired write it anymore tonight, so until next time, fuck you all
-5/6/98

JC-001-06008

It has been confirmed, after getting my yearbook and watching people like [redacted] and [redacted] the human race isn't worth fighting for, only worth killing. give the Earth back to the animals, they deserve it infinitely more than we do. nothing means anything anymore, most quotes are worthless, especially the rearranged ones like "don't fight your enemies, make your enemies fight" you know, quotes that use the same phrase, just rearranged, dumb fuck shit, ~~to be so sharp~~ wear its funny, people say "you shouldn't be so different." To me, and IST I say fuck you don't tell me what I should and should not be and IAD mother fuckers different is good, I don't want to be like you or anyone which is almost impossible this day w/ all the little shits trying to be "original-copy cats", I expect shits like you to criticize anyone who isn't one of your social words, "normal" or "civilized" → see: Tempest and Caliban: all you degrading worthless shits. all caught up and brainwashed into the 90s society. "what? you AREN'T going to college, are you crazy?" holy ~~shit~~ that is one fucking B I quote that just proves my point. step back and look at yourself fuckers, I dare you, maybe I'll get lucky and you'll step back to far like Nick in E/M3. w/ the same consequences.

—5/9/98

wooh, different pen. HA! alright you pathetic fools listen up; I have figured it out. the human race strives for excellence in life and community. always wanting to bring more "good" into the comm. and nullify "bad" things. anyone who thinks differently than the majority ~~or~~ or the leaders is deemed "unusual" or weird or irrag. people want to be a part of something, a family, a service, a club, a union, a community, whatever. that's what humans want. who cares what you as an individual thinks, you must do what you are told, whether it's jump off a bridge or drive on the right side of the road. protesters in the past protested because the human race that was dominant (Ghandhi and the Brits or the King and the Americans) ~~wasn't~~ wasn't working out = they had fault = they failed = their ideas didn't work. humans don't change that much, they only get better technology to do their work quicker/easier. people always say we shouldn't be racist. why not? Blacks ARE different. like it or not they are. they started out on the bottom so why not keep em there. it took the centuries to convince us that they are equal but they still use their color as an excuse, or they just ~~do~~ discriminate us because we are white. Fuck you, we should ship yer black asses back to Africa-fucking-ca where you came from. we brought you here and we will take you back. America = white. Gays... well all gays, ALL gays, should be killed. m.t freine fragen. lesbians are fun to watch if they are hot but still, its not human. its a fucking disease. you don't see bulls or roosters trying

Here's something to chew on... today I saw a program on the discovery channel about satellites and radar and aircraft and stuff, and at the end of the show the narrator said some things that made me think "damn, we are so advanced, we kick ass, america is awesome, we have so many things in our military, we would kick anyone's ass." for a minute I actually had some pride in our nation... then I realized, "hey, this only the Good things that I am seeing here. only the Pros, not the cons. maybe that's what people see, only the Pros, and that's why they are under control, but me, I see all... you can only blind me for so long. but alas, I have realized that Yes, the human race is still indeed doomed. It just needs a few kicks starts, like me, and hell, maybe even [redacted] if I can whip a few cities off the map, and even the fuckhead holding the map, then great. hmmm, just thinking if I want All humans dead or maybe just the quote-unquote "civilized, developed, and known-of" places on Earth, maybe leave little tribes of natives in the rain forest or something, hmmm. I'll think about that. eh, done for tonight -RFB- 6/13/85

As part of the human race, and having the great pleasure of being blessed with a brain, I can think. Humans can do whatever they want. There are no laws of nature that prevent humans from making choices. maybe from actually GOING some of those choices, but not from making the choices. If a man chooses to speed while driving home one day, then it is his fault for whatever happens. ~~That's~~ if he crashes into a school bus full of kiddies and they all bruen to death, it's his fault. It's only a tragedy if you think it is, and then it's only a tragedy in your own mind. so you shouldn't expect others to think that way also. it could also be a miracle for another person, maybe that bus stopped the car from plowing into a little old lady walking on the sidewalk, one could think it was a "miracle" that she wasn't hit. you see, anything and everything that happens in our world is just that, a HAPPENING. anything else is relative to the observer, but yet we try to have a "universal law" or "code" of what is good and bad and that just isn't function correct. we shouldn't be allowed to do that, we aren't GODS. just because we are at the top of the food chain with our technology doesn't mean we can be "judges"

of nature, sure we can think what we want, but you can
"think" and "believe" you can judge people and nature
all you want, but you are still wrong. ~~when~~ should
your morals apply to everyone else. "morale" is just
another word and that's it. I think we are all a waste
of natural resources and should be killed off, and since
humans have the ability to choose, and I'm human
I think I will choose to kill and damage as much
as nature allows me to, so ~~take that~~ fuck you,
and eat napalm & lead! HA! only nature can stop me.
I know I could get shot by a cop after only killing a single
person, but hey guess the fuck w/HAT! I choose to kill
that one person so get over it! it's MY fault, not my
parents, not my brother, not my ~~friends~~, not my favorite
bands, not computer games, not the media, FT is MINE!
so shut the fuck up!

-KLB- 7/29/98

someones bound to say "what were they thinking?" when we
go NPK ~~or~~ when we were planning it, so this is what I
am thinking. "I have a goal to destroy as much as possible
so I must not be sidetracked by my feelings of sympathy,
mercy, or any of that, so I will force myself to believe
that everyone is just another monster from Doom like FT
or FS or demons, so it's either me or them, I have to turn
off my feelings." keep this in mind, I want to burn the world,
I want to kill everyone except about 5 people, who I will
name later, so if you are reading this you are lucky you escaped
my rampage because I wanted to kill you. It will be very
tricky getting all of our supplies, explosives, weapons, ammo, and
then hiding it all and then actually planting it all so we can
achieve our goal. but if we get busted any ~~at~~ time, we start
killing them and there, just like Wilks from the ALIENS books,
I ain't going out without a fight.

Once I finally start my killing, keep this in mind, there are probably about 100 people max in the school alone who I don't want to die, the rest, MUST FUCKING DIE! If I didn't like you or if you pissed me off and lived through my attacks, consider yourself one lucky god damn NIGGER. Pity that a lot of the dead will be a waste in some way, like dead hot chicks who were still virgins, they could have been good fucks. Oh well, two fucking bad-life isn't fair... not by a long fuckin' shot when I'm at the wheel, too, God I want to torch and level everything in this whole fucking area but bombs of that size are hard to make, and plus I would need a fuckin' fully loaded A-10 to get every store on Wadsworth and all the buildings downtown. heh, I imagine THAT ya fuckers, picture half of Denver on fire just from me and vodka. ~~napalm~~ napalm on sides of skyscrapers and car garages blowing up from exploded gas tanks... oh man that would be beautiful. - 10/23/98

You know what, I feel like telling about lies, I lie a lot, almost constant, and to everybody, just to keep my own ass out of the water. and by the way ^(side note) I don't think I am doing this for attention, as some people may think. Let's see, what are some big lies I have told; "yeah I stopped smoking," "for doing it not for getting caught," "no I'm haven't been making more bombs," "no I wouldn't do that," and of course, countless of other ones, and yeah I know that I hate liars and I am one myself, oh fucking well. It's ok if I am a hypocrite, but no one else, because I am higher than you people, no matter what you say, if you disagree I would shoot you. And I am one racist mother fucker too, fuck the niggers and spics and chinks, unless they are cool, but sometimes they are so fucking retarded they deserve to be ripped on. some people go through life begging to be shot, and white fucks are just the same. if I could rule the world I would, because so far I hate you all. there are probably around 10 people I wouldn't want to die, but hey, who ever said life is fair should be shot like the others too. - 11/1/98

KKK

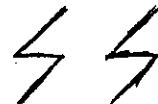

JC-001-026013

heh heh heh. I sure had fun this weekend. Let's see, what really happened. Before going to Rock n bowl we stopped by King Soopers and some and [redacted] picked up some big ass stoggs. We then went to Rock n bowl and I had a few cigarettes and one of my brand new cigars. We then went back to [redacted] house where her mom had previously bought us all a fuck load of liquor. personally, I had asked for Tequilla and Irish cream, vodka got his vodka, and there was beer, whiskey, schnapps, suckers, scotch, and of course, orange juice! so we had some fun there playing cards and making drinks. we eventually made it to bed at about 5 AM. got up at 10, went to safeway got some donuts and then I took ~~the~~ vodka home. The bottle of Tequilla is almost full and is in my car, right by my spare tire and right by the bottle of Irish cream. heh heh. I'll have to find a spot for those. and by the way, this mag's report is boosting my love of killing even more. like the early Nazi government, my brain is like a sponge, sucking up everything that sounds cool and leaving out all that is worthless, that's how Nazism was formed, and that's how I will be too! 11/8/98

Fuck you Brady! all I want is a couple of guns, and thanks to your fucking bill I will probably not get any! come on, I'll have a clean record and I only want them for personal protection, it's not like I'm some psycho who would go on a shooting spree... fuckers. I'll probably end up nuking everything and fucking robbing some gun collectors house. Fuck, that'll be hard. oh well, just as long as I kill a lot of fucking people. Everyone is always making fun of me because of how I look, how fucking weak I am and shit, well I will get you all back! ultimate fucking revenge here. you people could have shown more respect, treated me better, asked for my knowledge or guidance more, treated me more like a senior, and maybe I wouldn't have been so ready to tear your fucking heads off. Then again, I have always hated how I looked, I make fun of people who look like me, sometimes without even thinking sometimes just because I want to rip on myself. That's where a lot of my hate grow from, the fact that I have practically no self-esteem, especially concerning girls and looks and such. Therefore people make fun of me... constantly... therefore I get no respect and therefore I get fucking PTSD as of this date I have enough explosives to kill about 100 people, and then if I get a couple bayonets, swords, axes, whatever I'll be able to kill at least 10 more. and that just isn't enough!

Guns! I need guns! Give me some fucking firearms!
11/12/98

HATE! I'm full of hate and I Love it. I HATE PEOPLE, and they better fucking fear me, if they know what's good for em. ~~yes~~ I hate and I guess I want others to know it, yes I'm racist and I don't mind. Niggs and spies bring it on to them selves, and another thing, I am very racist towards white trash p.o.s.s like [redacted] and [redacted] they deserve the hatred, otherwise I probably wouldn't hate them. It's a tragedy, the human nature of people will lead to their downfall. Peoples human nature will get them killed. whether by me or vodka, it's happened before, and not just in school shootings like those pussy dumbasses over in Minnesota who squeaked throughout history, it's our fucking nature! I know how people are and why and I can't stand it! I love the nazis too... by the way, I fucking can't get enough of the swastika, the SS, and the iron cross. Hitler and his head boys fucked up a few times and it cost them the war, but I love their beliefs and who they were, what they did, and what they wanted. I know that form of gov couldn't have lasted long once the human equation was brought in, but damn it sure looked good. every form of gov leads to downfalls, everything will always fuck up or yeah something it's all Doomed. god damn it. this is beginning to make me get in a corner. I'm showing too much of myself, my views and thoughts, people might start to wonder, smart ones will get nossey and something might happen to fuck me over, I might need to put on one helluva mask here to god you all some more. fuck fuck fuck it'll be very fucking hard to hold out until April. If people would give me more compliments all of this might still be avoidable... but probably not. whatever I do people make fun of me, and sometimes directly to my face. I'll get revenge soon enough. fuckers shouldn't have ripped on me so much huh! HA! Then again it's human nature to do what you did... so I guess I am also attacking the human race. I can't take it, it's not right... true... correct... perfect. I fucking hate the human equation. Nazism would be fucking great if it weren't for individualism and our natural instinct to ask questions, you know what maybe I just need to get laid. maybe that'll just change some shit around that's another thing, I am a fucking dog. I have fantasies of just taking someone and fucking them hard and strong. someone like [redacted] were I just ~~pick~~ pick her up, take her to my room, tear off her shirt and pants and just eat her out and fuck her hard. I love flesh... weisses fleisch! dein weisses fleisch erregt mich so... Fch 6. in dich nur ein Gigito! I want to grab a few different girls in my gym class, take them into a room, pull their pants off and fuck them hard. I love flesh... the smooth legs, the large breasts, the ~~flawless~~ flawless body, the eyes, the hair, jet black, blond, white, brown, ahhh I just want to fuck! call it teenage hormones or call it a crazy fuckin racist rapist... es ist mir egal

I just want to be surrounded by the flesh of a woman, someone like [redacted] who I wanted to just fuck like hell, she made me practically drool, when she wore those shorts to work... intout hard on. - I couldn't stop staring. and others like [redacted] in my gym class, [redacted] or whatever in my gym class, and others who just want to ~~over~~ power and engulf myself in them. mmm I can taste the sweet flesh now... the salty sweet, the animalistic movement... - Facchhh... lizebe... - - - fleiscchhhhh... who can I trick into my room first? I can sweep someone off their feet, tell them what they want to hear, be all nice and sweet, and then "fuck em like an animal, feel them from the inside" as Pezner said. oh - that's something else... that one NIN video I saw, broken or closer or something, the one where the guy is kidnapped and tortured like hell... actual hell. I want to do that too. I want to tear a throat out with my own teeth like a pop can. I want to get someone with my hand, to tear a heart off and rip out the heart and lungs from the neck, to stab someone in the gut, shove it up to the heart, and yank the fucking blade out of their rib cage! I want to grab some weak little freshman and just tear them apart like a fucking wolf. show them who is god. strangle them, squish their head, bite their temples into the skull, rip off their jaw. rip off their collar bones, break their arms in half and twist them around, the lovely sounds of bones cracking and flesh ripping, ahh... so much to do and so little chances. - 11/17/98

"weisses
Fleisch"
- perfect
- song
- for
- me.

well folks, today was a very important day in the history of K. Today, along with vodka and someone else who I won't name, we went downtown and purchased the following; a double barrel 12ga. shotgun, a pump action 12ga. shotgun, a 9mm carbine, 250 9mm rounds, 15 12ga slugs, ~~and~~ 40 shotgun shells, 2 switch blade knives, and a total of 4-10 round clips for the carbine. we... have... **GUNS!** We fucking got em you sons of bitches! HA!! HAHAAA! neener  Booga Booga, heh. its all over now, this capped it off, the point

of no return, I have my carbine, shotgun, ammo and knife all in my trunk tonight and they'll stay there till tomorrow... after school you know, its really a shame. I had a lot of fun at that gun show, I would have loved it if you were there dad. we would have done some major ~~bonding~~ bonding. would have been great. oh well. but, alas, I fucked up and told [redacted] about my flask that really disappoints me [redacted]. I know you thought it was good for me in the long run and all that shit, smart of you to give me such a big raise and then eat me out, you figure it was supposed to cancel ~~each other~~ each other? god damn flask, that just fucked me over big time. now you'll will be on my ass even more than before about being on track. I'll get around it though, I have to cheat and lie to everyone from that fine. THIS is what I am motivated for, THIS is my goal, THIS is what I want "to do with my life". you know what word, I don't feel like punching through a door because of the flask deal, probably can't

I am fucking armed ~~now~~. I feel more confident, stronger, more God-like. I have confidence in my ability to deceive people, hopefully I'll make it to April, but that might not happen. U9, It's been a busy weekend, I need to sleep, I'll continue tomorrow.

11/22/98

Yesterday we fired out first actual firearms ever. 3 rounds from the carbine. taught that ground a thing or 2. I even had the 2 clips in my pocket while talking to vodka's dad about senior ditch day, God it felt great firing off that bad boy, and hopefully I'll be able to get more than just 4 clips for it. I dubbed my shotgun "Ariene" after Arlene Sanders from the Doom books. She always did love the shotgun. Vodka's DB is looking very fucking awesome, all cut down to the proper lengths. This is a bitch trying to keep up on homework while working on my guns, bombs, and lying. ~~by~~ by the way, I bought that flask in the mall and I had a friend fill it up w/ scotch whiskey, only had about 3 swigs in the 3 weeks I had it. plus monday I gave my T and IC to Vodka, just in case. I never really did like alcohol, just wasn't my thing, but it felt good to ~~just~~ have around. That argument on the 22nd was a real bitch, but I think I should have won a fucking oscar. I even quoted a few movies, remember "what the hell am I gonna do now man?! what am I gonna do!?" that's good ole Hudson from aliens. Sounded good too. and hey god damnit I would have been a fucking great marine, it would have given me a reason to do good. and I would never drink and drive, either. It will be weird when we actually go on the rampage. hopefully we will have plenty of clips and bombs. I'm gonna still try and get my calico 9mm. just think, 100 rounds without reloading... hell yeah!

we actually may have a chance to get some machine pistols thanks to the Brady bill. If we can save up about 2000 real quick ~~too~~ and find someone who is 21+ we can go to the next gun show and find a private dealer and buy ourselves some bad-ass AB-10 machine pistols. clips for those things can get really fucking big too.

12/3/98

Woohoo, I'll never have to take a final again! feels good to be free. I just love Hobbes and Nietzsche. Well tomorrow I'll be ordering 9 more 10 round clips for my carbine. I'm gonna be so fucking loaded in about a month. the big things we need to figure out now is the time bombs for the commons and how we will get them in ~~the~~ and leave them there to go off, without any fuckin Jews finding them. I wonder if anyone will write a book on me. sure is a ton of symbolism, double meanings, themes, appearance vs reality shit going on here. oh well, it better be fuckin good if it is writtin.

12/17/98

uh, get this. KMFDM's new album is entitled "Adios" and its release date is April. how fuckin appropriate, a subliminal final "Adios" tribute to Reb and Vodka, thanks KMFDM... I ripped the hell into the system.

12/20/98

JC-001-026017

gens christ that was fucking close, fucking shitheads at the gun shop almost dropped the whole project. Oh well, thank god I can BS so fucking well. I went and picked up those babies today, so now I get 1305 those niggers WOAH.

The stereo is very nice, but having no insurance payments to worry about so I could concentrate on BOMB'S would have been better. Oh well, I think I'll have enough. now I just need to get vodka another gun.

12/29/98

Months have passed. Its the first Friday night in the final month. much shit has happened. vodka has a Tec 9, we test fired all of our babies, we have 6 time clocks ready, ~~39~~ 39 crickets, 24 pipe bombs, and the napalm is under construction. Right now I'm trying to get fucked and trying to finish off these time bombs. NPK came quick, why the fuck can't I get any? I mean, I'm nice and considerate and all that shit, but nooooo. I think I try to hard. but I kinda need to considering NPK is closing in. The amount of dramatic irony and foreshadowing is fucking amazing. Everything I see and hear I incorporate into NPK somehow. Either bombs, clocks, guns, napalm, killing people, any and everything finds some tie to it. feels like a Goddamn movie sometimes, I wanna try to put some mines and trip bombs around this town too maybe. Get a few extra frags on the scoreboard. I hate you people for leaving me out of so many fun things. And no don't fucking say "well thats your fault" because it isn't, you people had my phone#, and I asked and all, but no, no no no don't let the wierd looking Eric KID come along, ooh fucking nooo.

4/3/99

video

FE

aud

FB

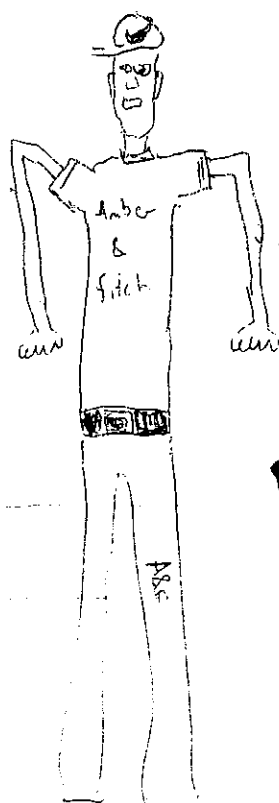
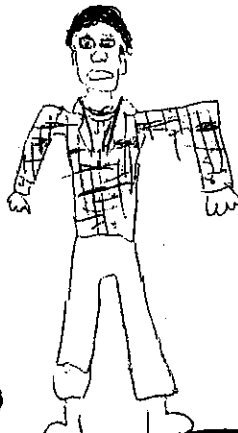

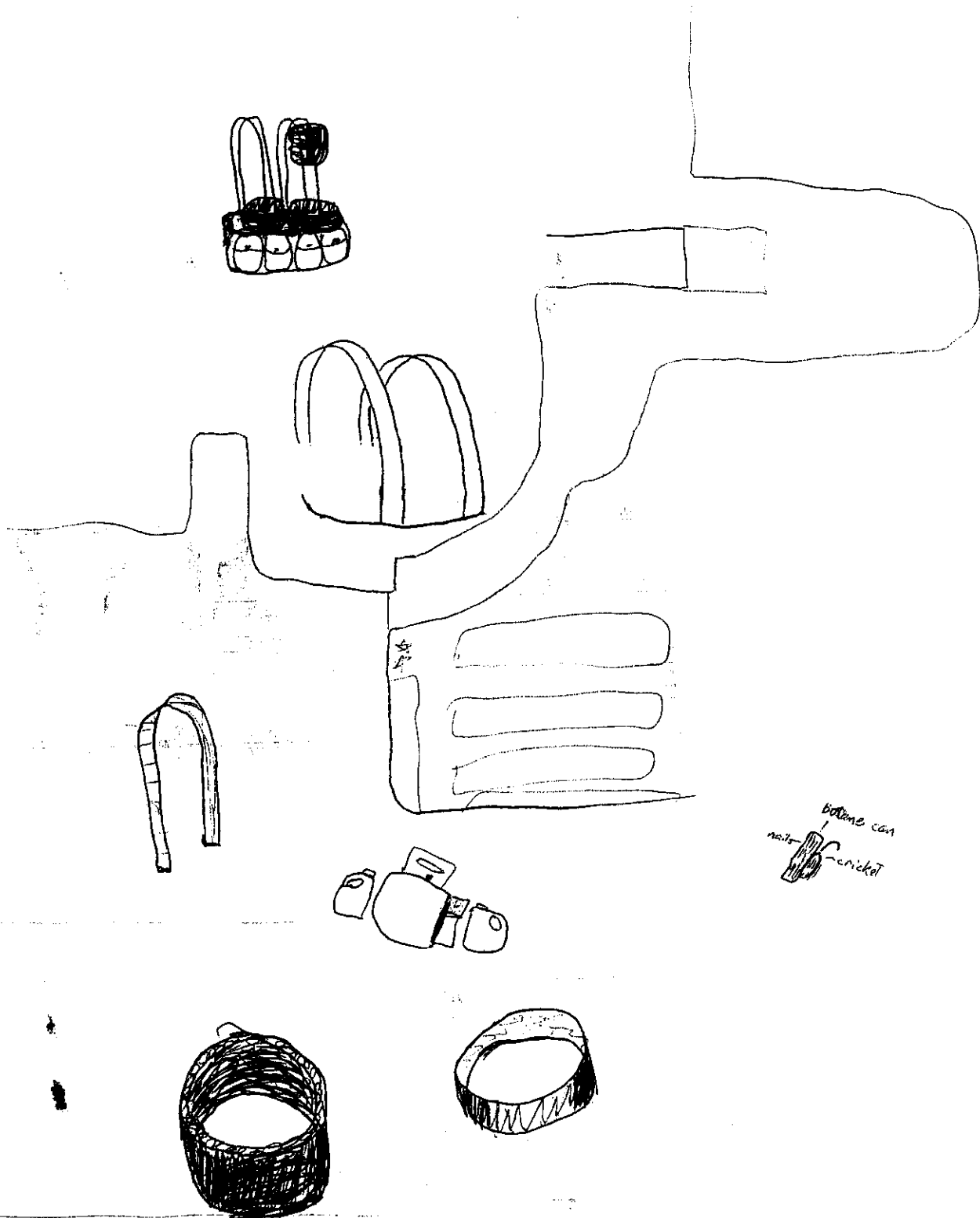

JC-001-026021

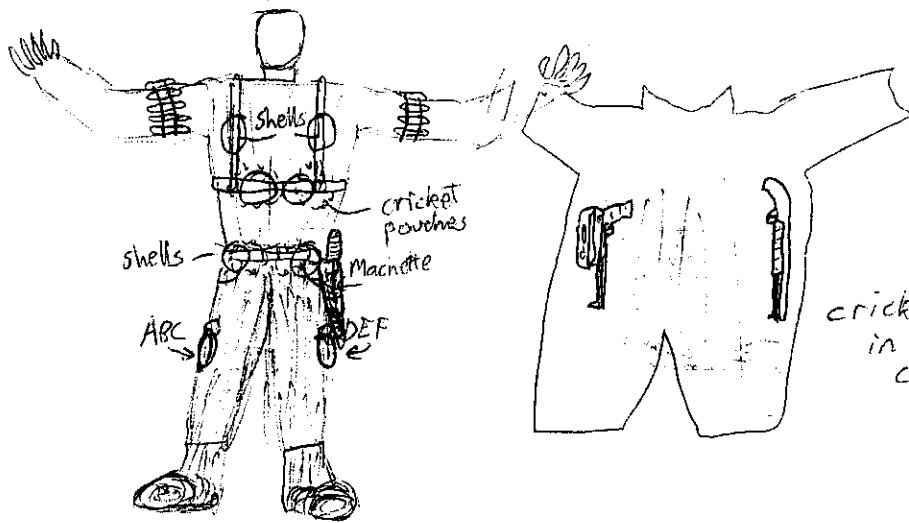

crickets + propyn.
 in all pockets,
 called clip in 1 though

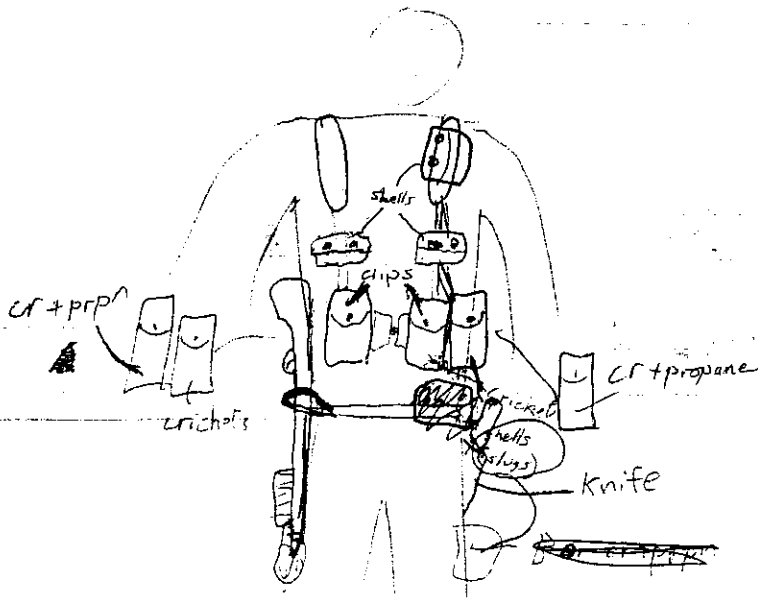
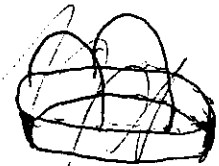
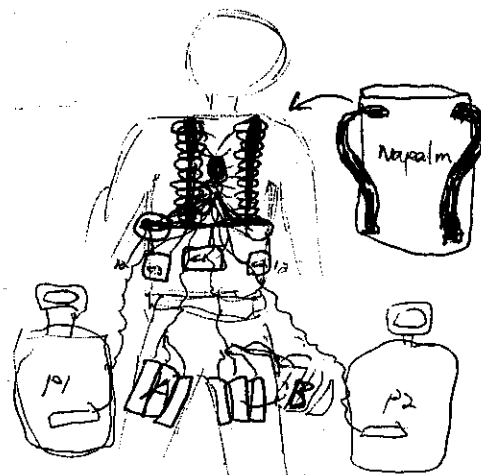
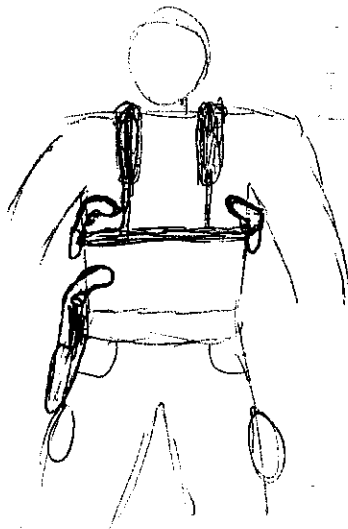

Cricket
 Alpha batch
 Beta batch
 Charlie batch

Size shrapnel loads # of bombs made

				272
		20	9	100
48	36	260	-	50
10	36	86		122
50	50	40		
Charlie = 12.5 lbs	108	295		22

~~Alpha 12.5 lbs~~

✓ 142+1
 ✗ 128+1

272

Batch	Size	Powder load	Shrapnel load	# made to date	Total made	Rating
Cricket	[REDACTED]	[REDACTED]	[REDACTED]	10-10/22/98 4-12/18/98 4-1/3/99 13- 9-2/8/99 2/0/99	39 used-1	excellent
Alpha	[REDACTED]	[REDACTED]	[REDACTED]	3-10/22/98	3	OK
Beta	[REDACTED]	[REDACTED]	[REDACTED]	1-10/22/98 6-10/23/98	6	good
Charlie	[REDACTED]	[REDACTED]	[REDACTED]	3-10/31/98	3	excellent
Delta	[REDACTED]	[REDACTED]	[REDACTED]	3-1/9/99 5-3/29/99	8	excellent
Echo	[REDACTED]	[REDACTED]	[REDACTED]	2-3/19/99	2	excellent
Foxtrot	[REDACTED]	[REDACTED]	[REDACTED]	2-3/29/99	2	excellent
Super Crickets	[REDACTED]	[REDACTED]	[REDACTED]	14-4/14/99		excellent

Have
~~\$300~~
 200 money
 order
 wise
~~\$200~~ 46 CDs
~~\$200~~ - 4-6mmth. ~~AT~~
 300 - at 3/26
 +
 200 - at 4/9
 +
 80 \$ P

Need
~~\$500~~
~~\$100~~ (ammunition)
~~\$50~~ shells
~~\$100~~ patches, ~~ammunition~~ ~~things~~
~~\$200~~
 \$20 - Gasoline
~~\$100~~
 \$200+ Explosives (Propane tanks, camping fuel tanks, etc)
 16-18 + 4 clips - holster
 (machine pistol)
 suspenders

150-R-25

\$50 per tank

shit left
 to do at 3/22/99

~~* figure out napalm
 recipe + storage
 area.~~

~~Shotgun~~ ~~patches~~ ~~clips~~
~~Shotgun~~ ~~shells~~ ~~assault weapon~~
 Explosives: ~~Bullets~~ ~~time Bombs~~

- time schedule
 the commons/
 people patterns

- 9mm ammo (150-200)
 - shells (50-100)
 - practice in-car
 gear up

560

~~Lasers for carbine~~
 - get laid X
 - prepare explosives
 ~ distractions
 ~ commons
 ~ cars
 - grenades

230 - Propane (14) + refill
 25 - 9mm ammo (100)
~~200 - rock (20)~~
 15 - Gas (10-13 gal)
~~30 - lasers (2)~~

shotgun
 36 shells + 5 loaded
 carbine
 10 clips + 1 loaded
 switch blade
 boot knife
 long knife

3.8



Napalm Tests:

- ✓ [redacted] — shitty but in a fix would do ok
- ✓ [redacted] — good burning, very slick.
- ? [redacted] —
- ✓ [redacted] — worthless
- ✓ [redacted] — needs to be heated, no time
- ✓ [redacted] — worthless
- ✓ [redacted] — ok, needs more experiments (need to allow it to soak it and dissolve)
- ✓ [redacted] — worthless
- ✓ [redacted] — good but need larger testing boil
- ✓ [redacted] — heated? no time
- ✓ [redacted] —
- ✓ [redacted] —

CONTINUOUS

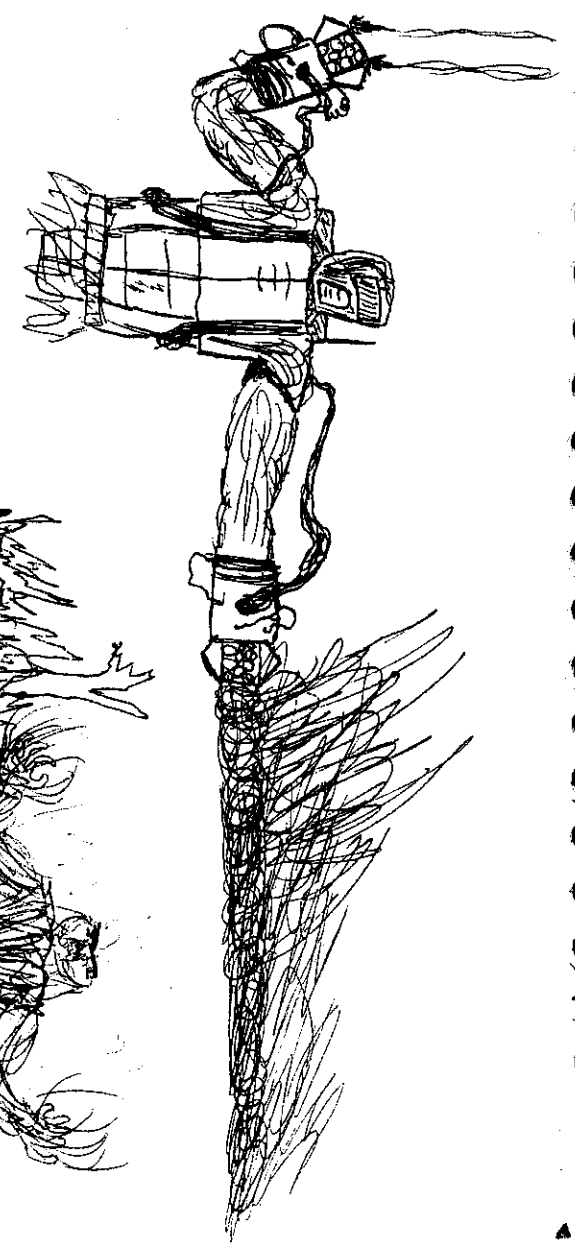
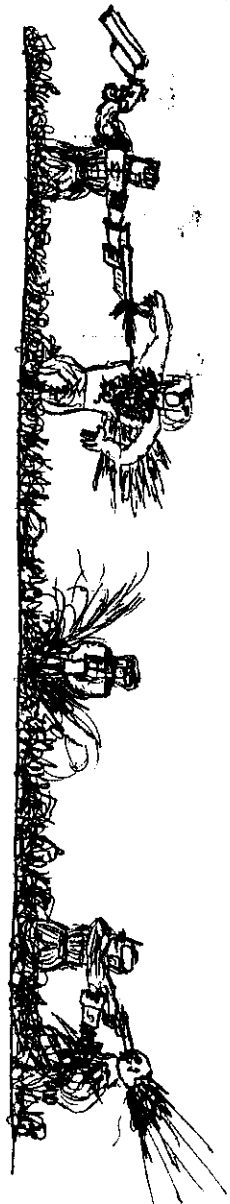
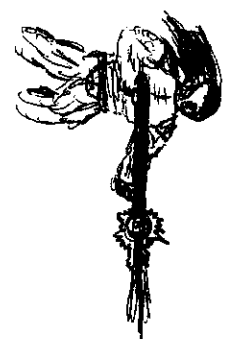

JC-001-026026

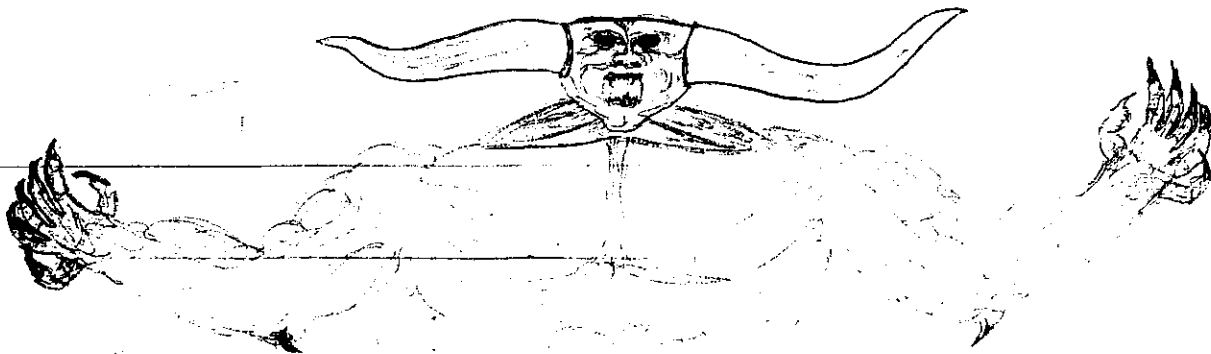

JC-001-026027

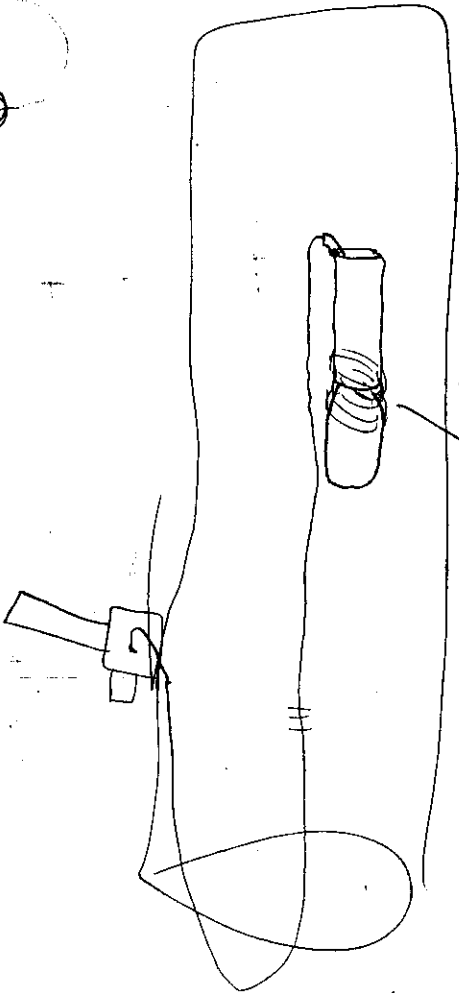
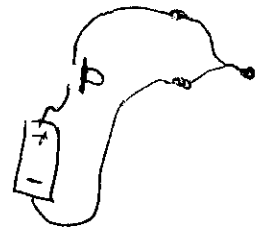
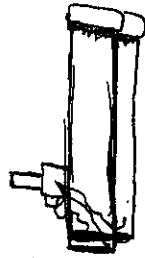
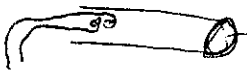
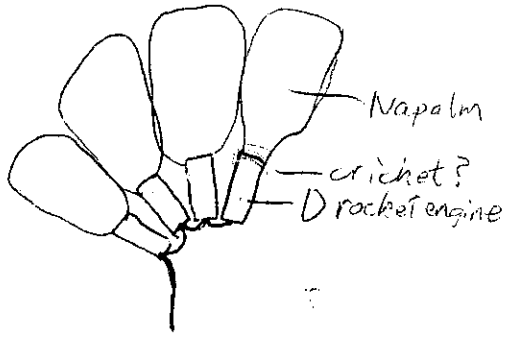
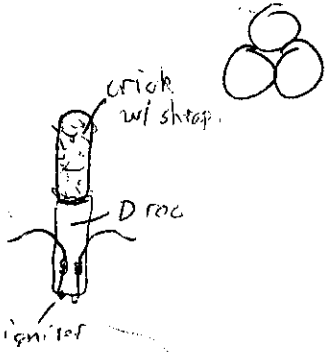

tape will cz exp. bef. main chng

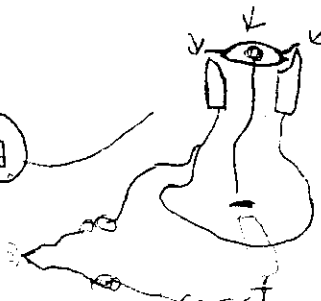
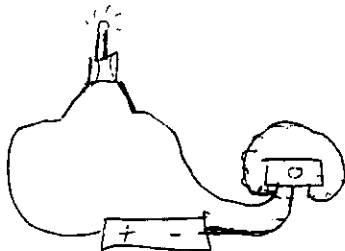
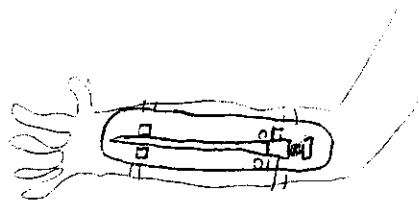
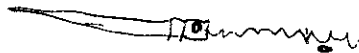
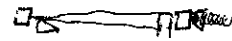

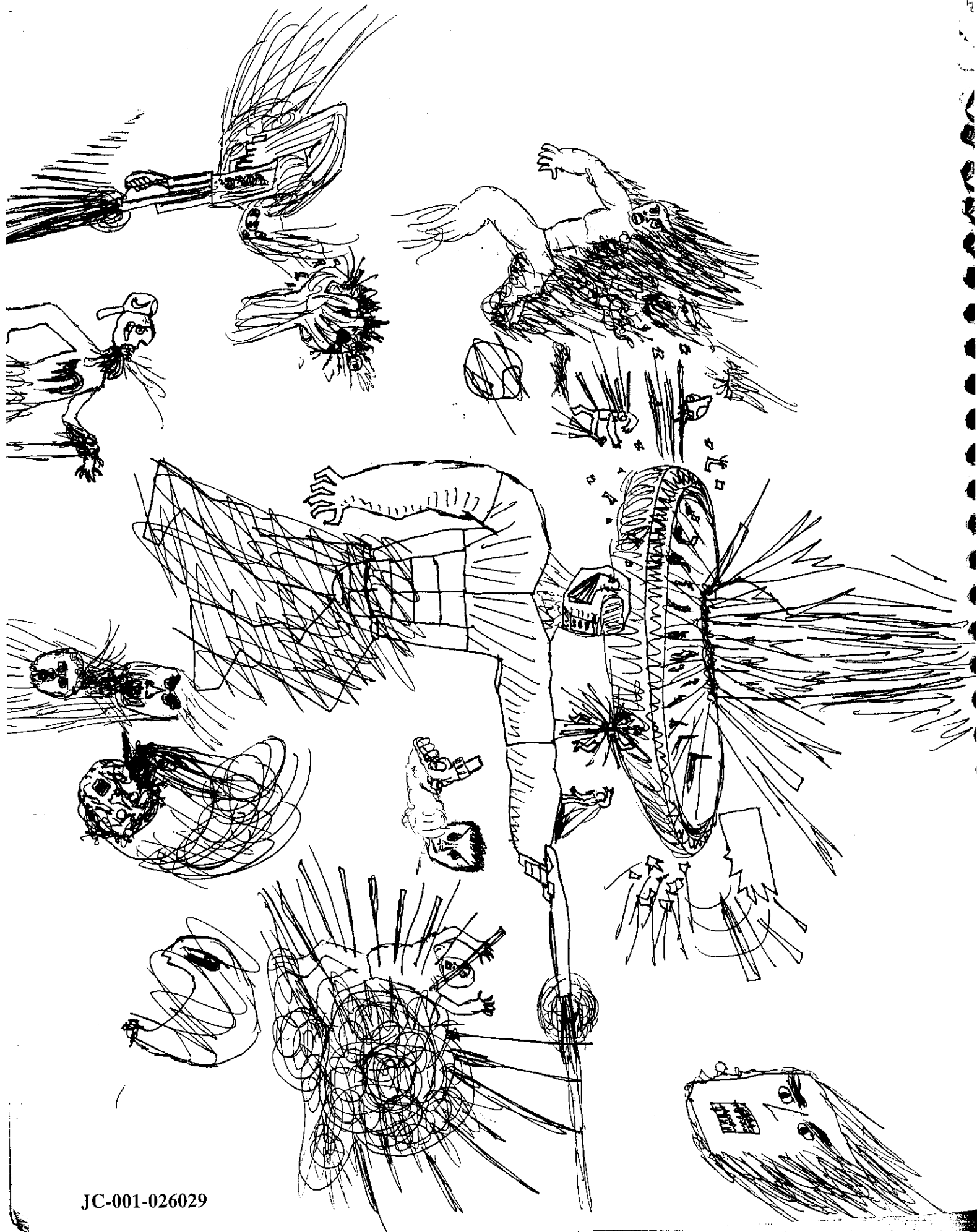

JC-001-026029

BUNKER; whiskey

4 MGs (mortar grenades)

1 cricket (black)

3 (Alpha Batch)

+ 10 crickets

18 explosives

NOTE CARD BOX

29 crickets

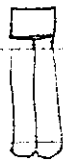

⊙ Demon spawner

code - 787-~~789~~
789 - normal
790 - ent 00-NORTH
code

sound - one of boss shooters (TIER 1)

Death - metallic clang

Frame - 787 (cube) - 789

Death Frame - ~~789~~ 790

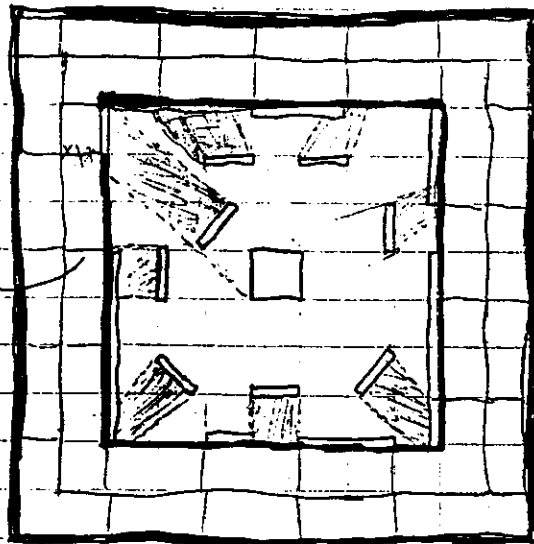
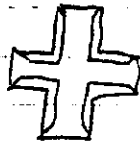
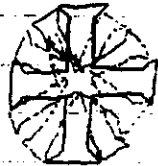

last raise
should be
2.5c high

2
33
8
264

achtung
bricks
champt (2)
dchronix
doom333
idmap01
realdoom
station
thrasher
truchamp
uac labs
whiskey
killer
Gravity
orbit4
assault
techout

Fava
lost episodes
Hacx
obtic
BSP
Deh
Edmap
wintex

- 1 - Elm1
- 2 - D-Elm2
- 3 - map16 (D-Dead2)
- 4 - map9.mid
- 5 - map1
- 6 - nin8 - ^{map 8, 20, 28, 31} _{13, 14, 2-1}
- 7 - D-victor

~~map9.mid~~
Ethereal
Engel
~~Arma~~
D-victor
map16
Elm1

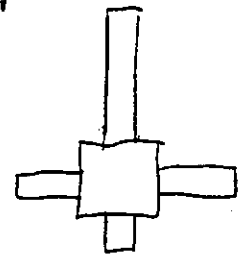
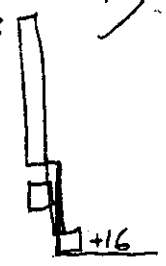

nin-2, 8, 12

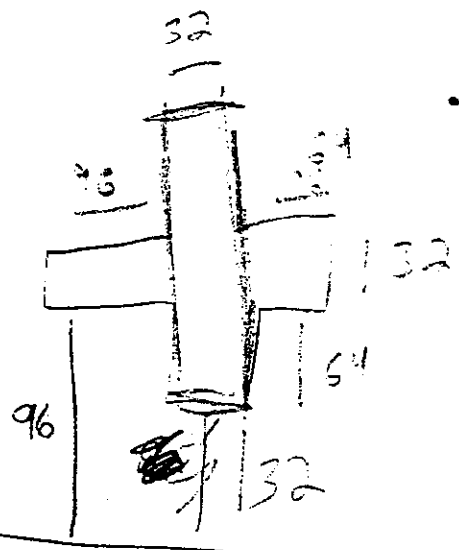
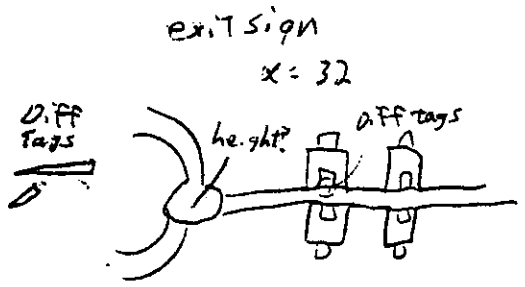

[Back to Aftermath](#) [Back to Hot Rocks](#) [Back to Flashpoint](#) [Back to Lyrics](#)

- *1
add teleporter takeout sw
- 1-2
*2
add Hallway takeout sw
- 3
-
- *4
add teleporter, takeout square exit sw
- *5
add telep. takeout sw
- 6

ggrat2-
 ggrat4 1
 5 3
 6 2
 7 2
 grat 2 1
 2
 3
 6

compl 4
 2 1
 3 3
 3 2-8
 4 1
 5
 7 1
 8 1
 9 1

v, 11 2 22 3 4 8 6 2 8 9

a compl 11, 22, 1-9
 corel, 2, tal compl, 2
 grate, 2, 3

2 12, 3, 6, 7, 8
 1-3 6-8
 pip 044
 w grate

1 - add a compl, 2, 9
 2 - add corel, 2

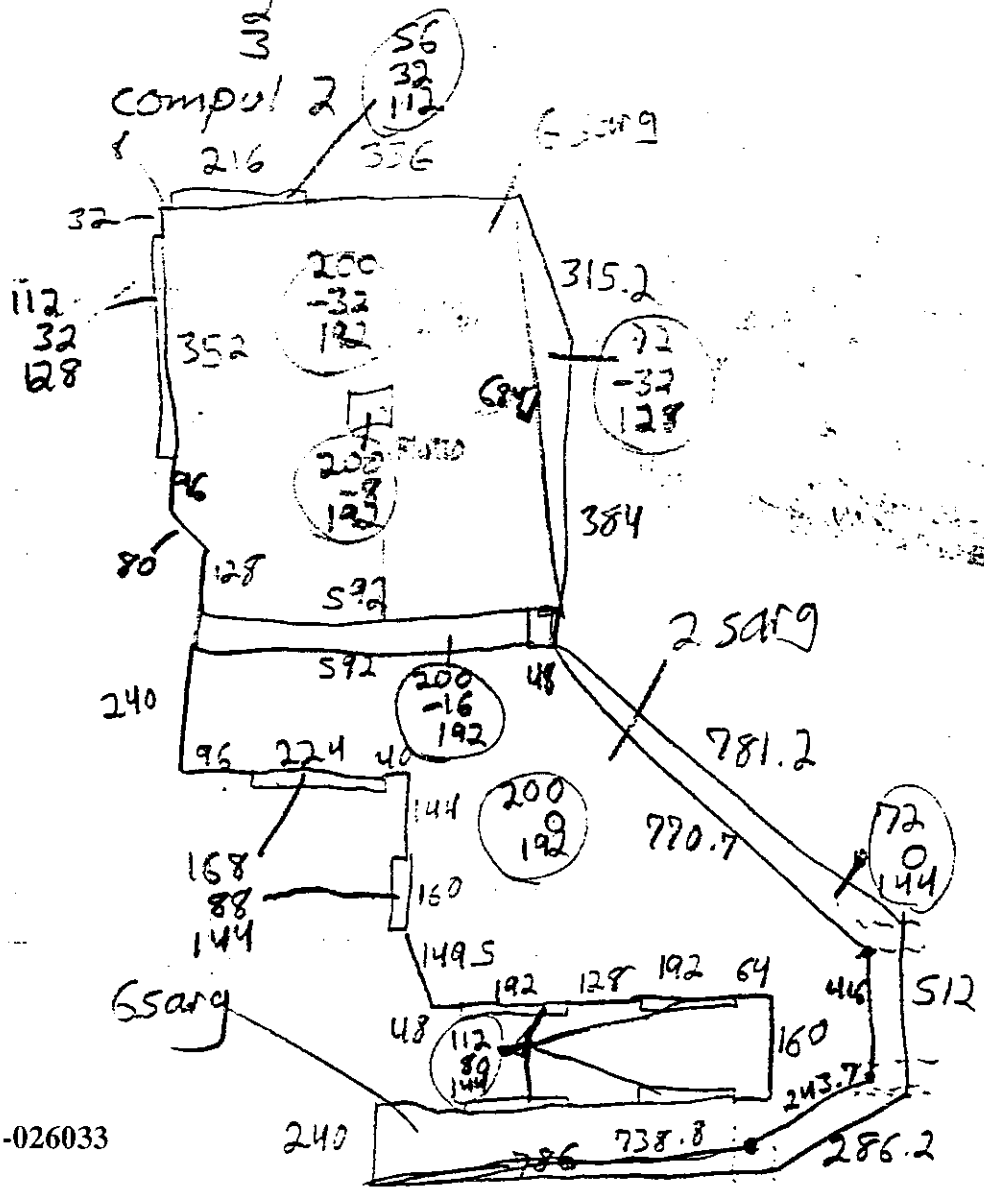

Volume in drive D is REBELDRIVE2
Volume Serial Number is 242A-13D4
Directory of D:\Q2\BASEQ2\TEXTURES\E1U1

[.]	[..]	[BACKUPS]	WAL2PCX.EXE	PSPBRWSE.JBF
BASELT~1.PCX	BASELT~2.PCX	BASELT~3.PCX	BASELT~4.PCX	BASELT~5.PCX
BASELT~6.PCX	BASELT~7.PCX	BASELT~8.PCX	BASEMA~1.PCX	BASEMA~2.PCX
BASEMA~3.PCX	BASEMA~4.PCX	BASELT_2.WAL	BASELT_B.WAL	BASEMAP.WAL
BASLT3_1.WAL	BROKEN2_.WAL	BTELEV_D.WAL	CGRBASE1.WAL	CITYCOMP.WAL
COLOR1_6.WAL	COMP01_2.WAL	COMP1_1.WAL	COMP1_2.WAL	COMP1_3.WAL
COMP1_4.WAL	COMP1_5.WAL	COMP1_7.WAL	COMP1_8.WAL	COMP2_1.WAL
COMP2_3.WAL	COMP2_4.WAL	COMP2_5.WAL	COMP2_6.WAL	COMP2_D.WAL
COMP3_1.WAL	COMP3_2.WAL	COMP3_3.WAL	COMP3_4.WAL	COMP3_5.WAL
COMP3_6.WAL	COMP3_7.WAL	COMP3_8.WAL	COMP4_1.WAL	COMP4_2.WAL
COMP4_3.WAL	COMP5_1.WAL	COMP5_2.WAL	COMP5_3.WAL	COMP5_4.WAL
COMP7_1.WAL	COMP7_2.WAL	COMP7_3.WAL	COMP8_1.WAL	COMP9_1.WAL
COMP9_2.WAL	COMP9_3.WAL	COMPUI_2.WAL	COMPUI_3.WAL	COMPU2_1.WAL
COOLANT.WAL	CORE1_1.WAL	CORE2_3.WAL	CORE3_1.WAL	CORE4_1.WAL
CORE4_4.WAL	CORE5_4.WAL	CORE6_1.WAL	CORE7_3.WAL	C_MET5_2.WAL
FLAT1_2.WAL	FUSE1_1.WAL	GRASS1_4.WAL	GRATE1_3.WAL	GRATE2_2.WAL
GRNX2_9.WAL	KCSIGN4.WAL	MON1_2.WAL	MON1_3.WAL	MON1_6.WAL
MON1_8.WAL	MONT1_4.WAL	MONT1_4T.WAL	MONT3_1.WAL	MONT3_2.WAL
OR01_2.WAL	OR02_3.WAL	PIPE1_3.WAL	RCOMP1_4.WAL	TIMPOD8.WAL

Press any key to continue . . .

BASELT~6.PCX	BASELT~7.PCX	BASELT~8.PCX	BASEMA~1.PCX	BASEMA~2.PCX
BASEMA~3.PCX	BASEMA~4.PCX	BASELT_2.WAL	BASELT_B.WAL	BASEMAP.WAL
BA T3_1.WAL	BROKEN2_.WAL	BTELEV_D.WAL	CGRBASE1.WAL	CITYCOMP.WAL
COLOR1_6.WAL	COMP01_2.WAL	COMP1_1.WAL	COMP1_2.WAL	COMP1_3.WAL
COMP1_4.WAL	COMP1_5.WAL	COMP1_7.WAL	COMP1_8.WAL	COMP2_1.WAL
COMP2_3.WAL	COMP2_4.WAL	COMP2_5.WAL	COMP2_6.WAL	COMP2_D.WAL
COMP3_1.WAL	COMP3_2.WAL	COMP3_3.WAL	COMP3_4.WAL	COMP3_5.WAL
COMP3_6.WAL	COMP3_7.WAL	COMP3_8.WAL	COMP4_1.WAL	COMP4_2.WAL
COMP4_3.WAL	COMP5_1.WAL	COMP5_2.WAL	COMP5_3.WAL	COMP5_4.WAL
COMP7_1.WAL	COMP7_2.WAL	COMP7_3.WAL	COMP8_1.WAL	COMP9_1.WAL
COMP9_2.WAL	COMP9_3.WAL	COMPUI_2.WAL	COMPUI_3.WAL	COMPU2_1.WAL
COOLANT.WAL	CORE1_1.WAL	CORE2_3.WAL	CORE3_1.WAL	CORE4_1.WAL
CORE4_4.WAL	CORE5_4.WAL	CORE6_1.WAL	CORE7_3.WAL	C_MET5_2.WAL
FLAT1_2.WAL	FUSE1_1.WAL	GRASS1_4.WAL	GRATE1_3.WAL	GRATE2_2.WAL
GRNX2_9.WAL	KCSIGN4.WAL	MON1_2.WAL	MON1_3.WAL	MON1_6.WAL
MON1_8.WAL	MONT1_4.WAL	MONT1_4T.WAL	MONT3_1.WAL	MONT3_2.WAL
OR01_2.WAL	OR02_3.WAL	PIPE1_3.WAL	RCOMP1_4.WAL	TIMPOD8.WAL

Press any key to continue . . .

(continuing D:\Q2\BASEQ2\TEXTURES\E1U1)
WINCOMP3.WAL WIRES2_1.WAL
94 file(s) 936,530 bytes
3 dir(s) 152,076,288 bytes free

D:\Q2\BASEQ2\TEXTURES\E1U1>

BASELT~6.PCX	BASELT~7.PCX	BASELT~8.PCX	BASEMA~1.PCX	BASEMA~2.PCX
BASEMA~3.PCX	BASEMA~4.PCX	BASELT_2.WAL	BASELT_B.WAL	BASEMAP.WAL
BASLT3_1.WAL	BROKEN2_.WAL	BTELEV_D.WAL	CGRBASE1.WAL	CITYCOMP.WAL
COLOR1_6.WAL	COMP01_2.WAL	COMP1_1.WAL	COMP1_2.WAL	COMP1_3.WAL
COMP1_4.WAL	COMP1_5.WAL	COMP1_7.WAL	COMP1_8.WAL	COMP2_1.WAL
COMP2_3.WAL	COMP2_4.WAL	COMP2_5.WAL	COMP2_6.WAL	COMP2_D.WAL
COMP3_1.WAL	COMP3_2.WAL	COMP3_3.WAL	COMP3_4.WAL	COMP3_5.WAL

JC-001-026034

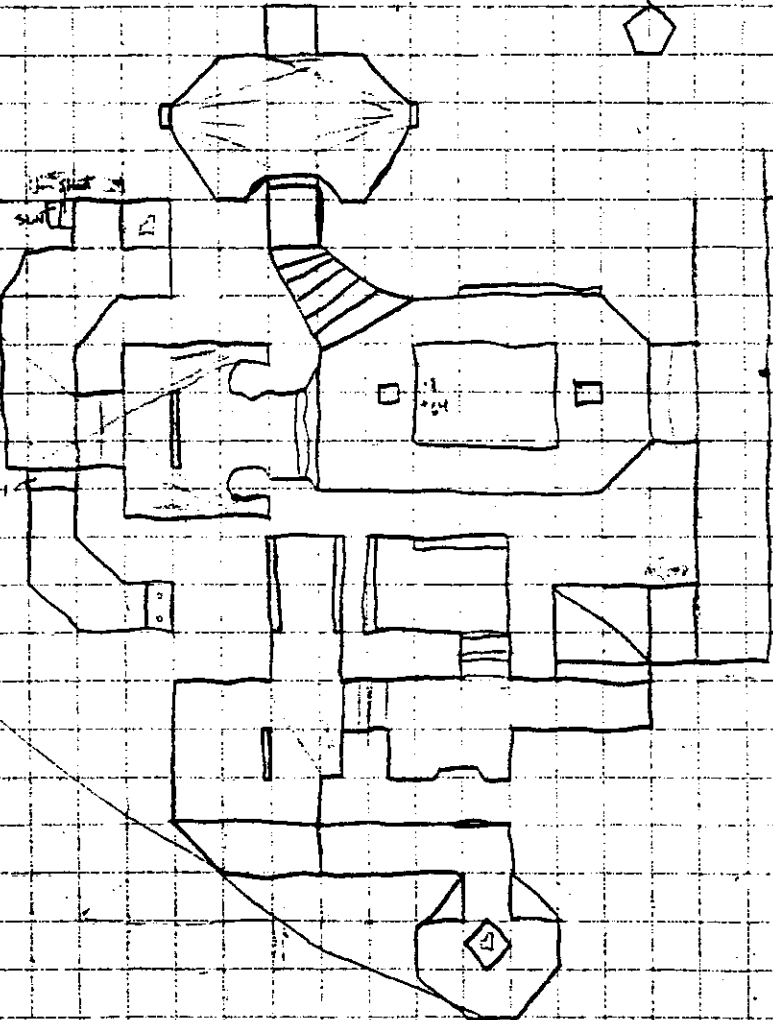
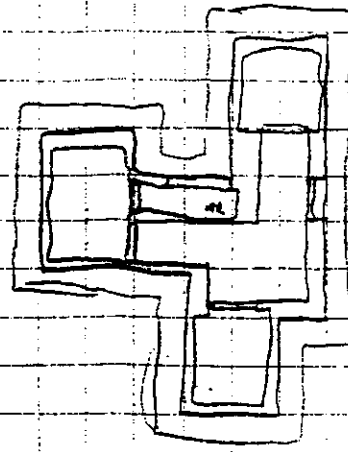
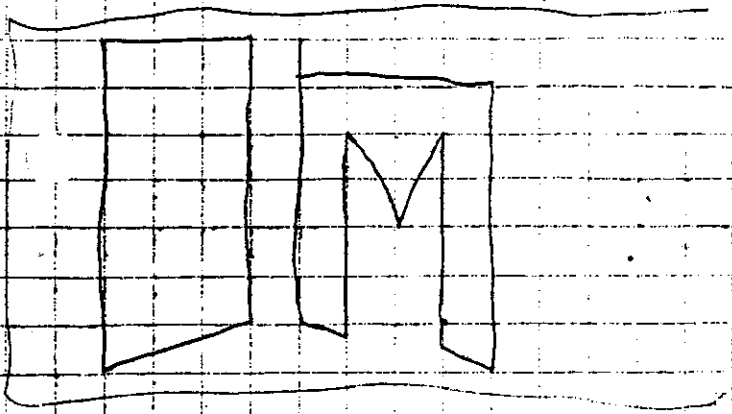

MAP
1

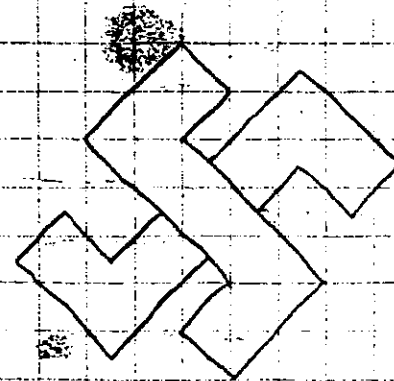
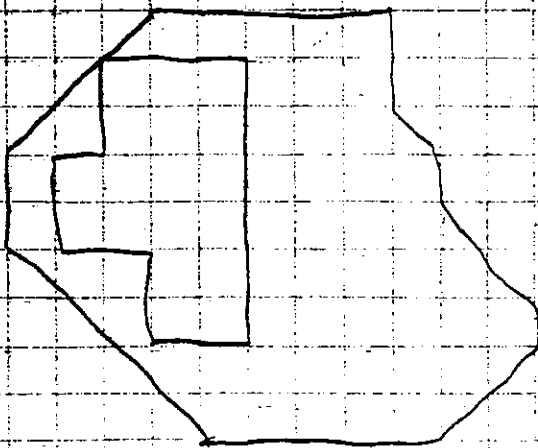

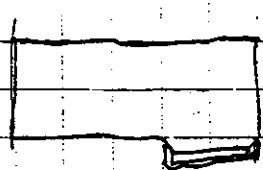
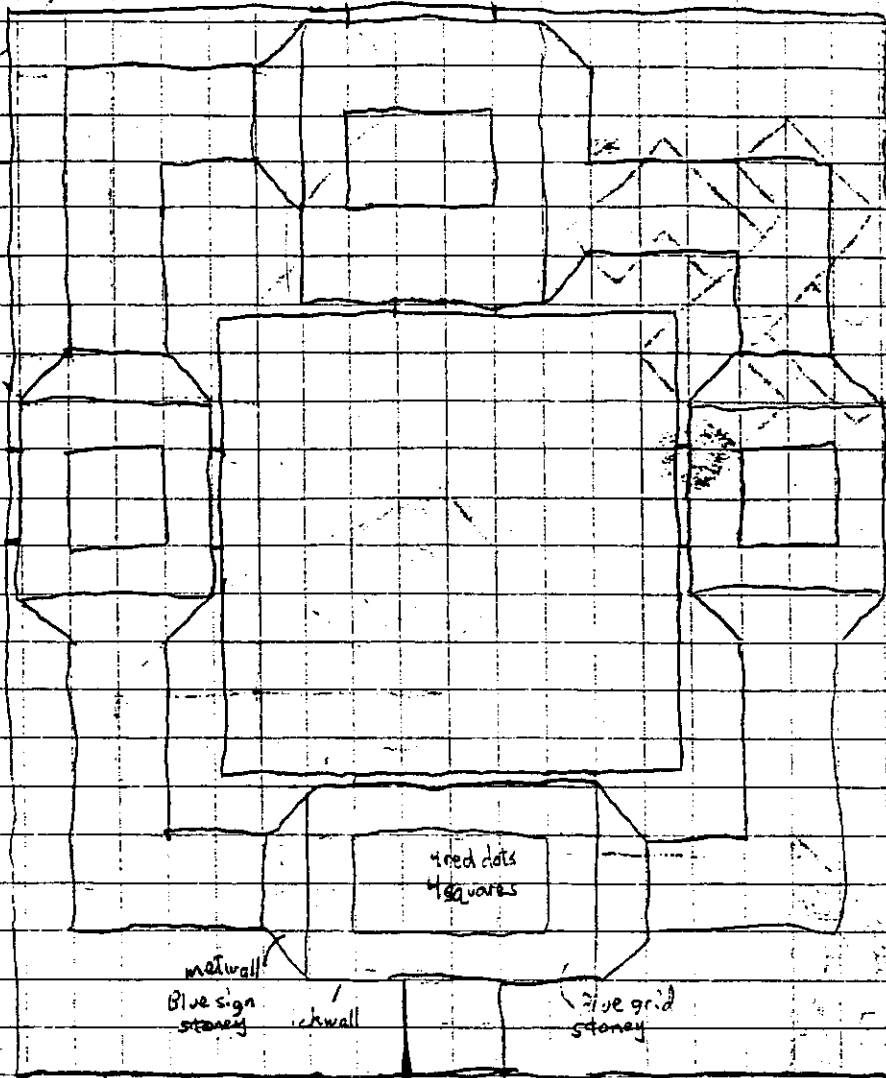

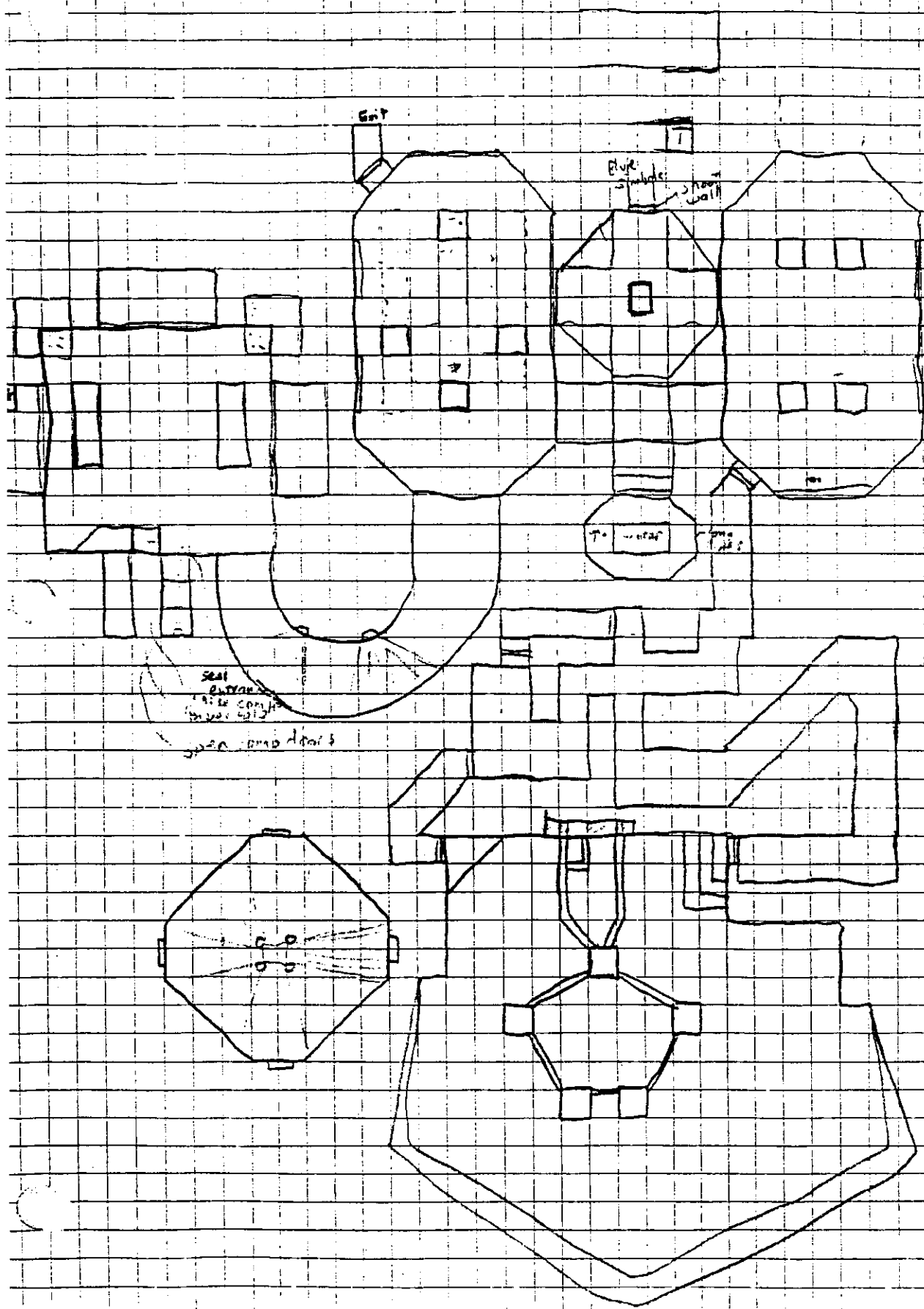

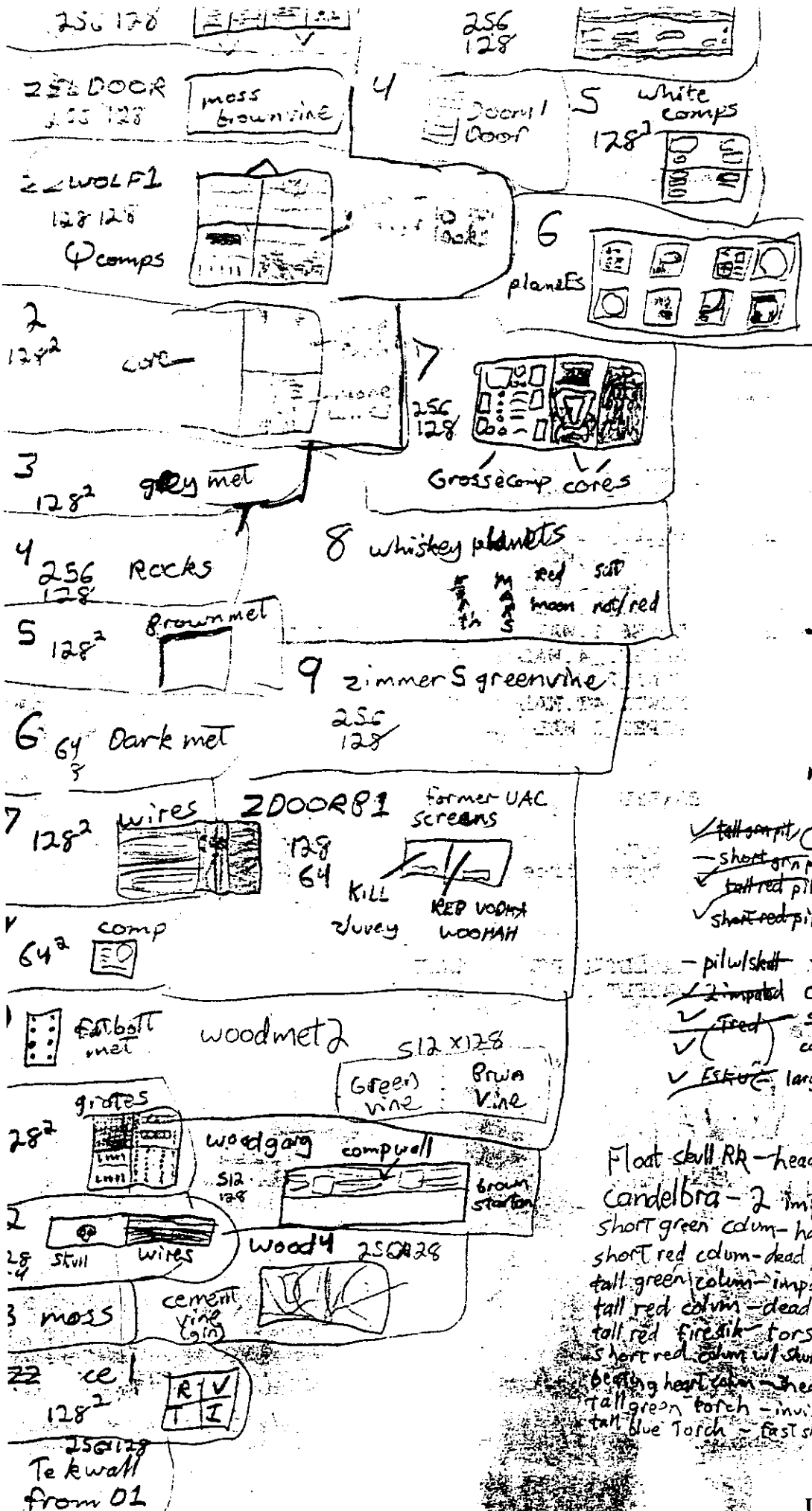
64 = lite met
 71 = Pad
 74 = lights

Nazi 4

- ✓ tall short Col 1a 0 - impaled hmn
- ✓ short green pil 1/2 - hanging half head/arm
- ✓ tall red pil 1/3 - dead plyrs head
- ✓ short red pil 1/4 - dead plyr no head
- pil w/ skull 6 - Hang body w/ expst br.
- ✓ 2 impaled candelbra 22:67
- ✓ (fixed) skulls on fire - head 27:11
- ✓ (fixed) col w/ heart = heads engel - (fan single edit.c
- ✓ Eskie large red fire w/ skulls = torso Our. s. g. 198

- Float skull RR - head 2
- Candelbra - 2 impaled
- short green col - hanging w/ half head
- short red col - dead player no head
- tall green col - impaled guy
- tall red col - dead plyrs head 1
- tall red fire dik - torso
- short red col w/ skull - hanging w/ brain
- beating heart col - heads
- tall green torch - invisimp
- tall blue torch - fast skull

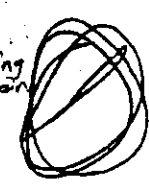

87 = Moving Floor Mats

FLAT1_2.WAL FUSE1_1.WAL GRASS1_4.WAL GRATE1_3.WAL GRATE2_2.WAL
 ERNX2_9.WAL KCSIGN4.WAL MON1_2.WAL MON1_3.WAL MON1_6.WAL
 MON1_8.WAL MONT1_4.WAL MONT1_4T.WAL MONT3_1.WAL MONT3_2.WAL
 OR01_2.WAL OR02_3.WAL PIPE1_3.WAL RCOMP1_4.WAL TIMPOD8.WAL
 Press any key to continue . . .

grey lines stone blocks

little

1800 554 1445
 Tapco
 magHP01

(continuing D:\Q2\BASEQ2\TEXTURES\E1U1)
 WINCOMP3.WAL WIRES2_1.WAL
 94 file(s) 936,530 bytes
 3 dir(s) 152,076,288 bytes free

tanHex tan step
 III

D:\Q2\BASEQ2\TEXTURES\E1U1>

BASELT~6.PCX	BASELT~7.PCX	BASELT~8.PCX	BASEMA~1.PCX	BASEMA~2.PCX
BASEMA~3.PCX	BASEMA~4.PCX	BASELT_2.WAL	BASELT_B.WAL	BASEMAP.WAL
BASLT3_1.WAL	BROKEN2_.WAL	BTELEV_D.WAL	CGRBASE1.WAL	CITYCOMP.WAL
COLOR1_6.WAL	COMP01_2.WAL	COMP1_1.WAL	COMP1_2.WAL	COMP1_3.WAL
COMP1_4.WAL	COMP1_5.WAL	COMP1_7.WAL	COMP1_8.WAL	COMP2_1.WAL
COMP2_3.WAL	COMP2_4.WAL	COMP2_5.WAL	COMP2_6.WAL	COMP2_D.WAL
COMP3_1.WAL	COMP3_2.WAL	COMP3_3.WAL	COMP3_4.WAL	COMP3_5.WAL
COMP3_6.WAL	COMP3_7.WAL	COMP3_8.WAL	COMP4_1.WAL	COMP4_2.WAL
COMP4_3.WAL	COMP5_1.WAL	COMP5_2.WAL	COMP5_3.WAL	COMP5_4.WAL
COMP7_1.WAL	COMP7_2.WAL	COMP7_3.WAL	COMP8_1.WAL	COMP9_1.WAL
COMP9_2.WAL	COMP9_3.WAL	COMPUI_2.WAL	COMPUI_3.WAL	COMPU2_1.WAL
COOLANT.WAL	CORE1_1.WAL	CORE2_3.WAL	CORE3_1.WAL	CORE4_1.WAL
CORE4_4.WAL	CORE5_4.WAL	CORE6_1.WAL	CORE7_3.WAL	C_MET5_2.WAL
FLAT1_2.WAL	FUSE1_1.WAL	GRASS1_4.WAL	GRATE1_3.WAL	GRATE2_2.WAL
GRNX2_9.WAL	KCSIGN4.WAL	MON1_2.WAL	MON1_3.WAL	MON1_6.WAL
MON1_8.WAL	MONT1_4.WAL	MONT1_4T.WAL	MONT3_1.WAL	MONT3_2.WAL
OR01_2.WAL	OR02_3.WAL	PIPE1_3.WAL	RCOMP1_4.WAL	TIMPOD8.WAL

Pr s any key to continue . . .

6
35
57
0

play - 28

3006
100
8
16
56
3
8
256
50

632
834
051
0
642
6
660

(continuing D:\Q2\BASEQ2\TEXTURES\E1U1)
 WINCOMP3.WAL WIRES2_1.WAL
 94 file(s) 936,530 bytes
 3 dir(s) 152,076,288 bytes free

D:\Q2\BASEQ2\TEXTURES\E1U1>

BASELT~6.PCX	BASELT~7.PCX	BASELT~8.PCX	BASEMA~1.PCX	BASEMA~2.PCX
BASEMA~3.PCX	BASEMA~4.PCX	BASELT 2.WAL	BASELT B.WAL	BASEMAP.WAL

585
587
583
0
589
585

0
51
26
17
27

101-SSsit
102-SSth

SSWVA 1-8

Eoddes 642 81-8

945-749
orig new

mia
maggiore

C1-8
D1-8

174	POSSA
176	A
187	G
184	E
189	H
194	M
203	R

21858
21876

Village east
colorado Blvd.
circuit city

EO Fire1
FO Fire2
GO Firing
HO ow

Death F749
Nazi 3.adeH

skip i-m NO-V0

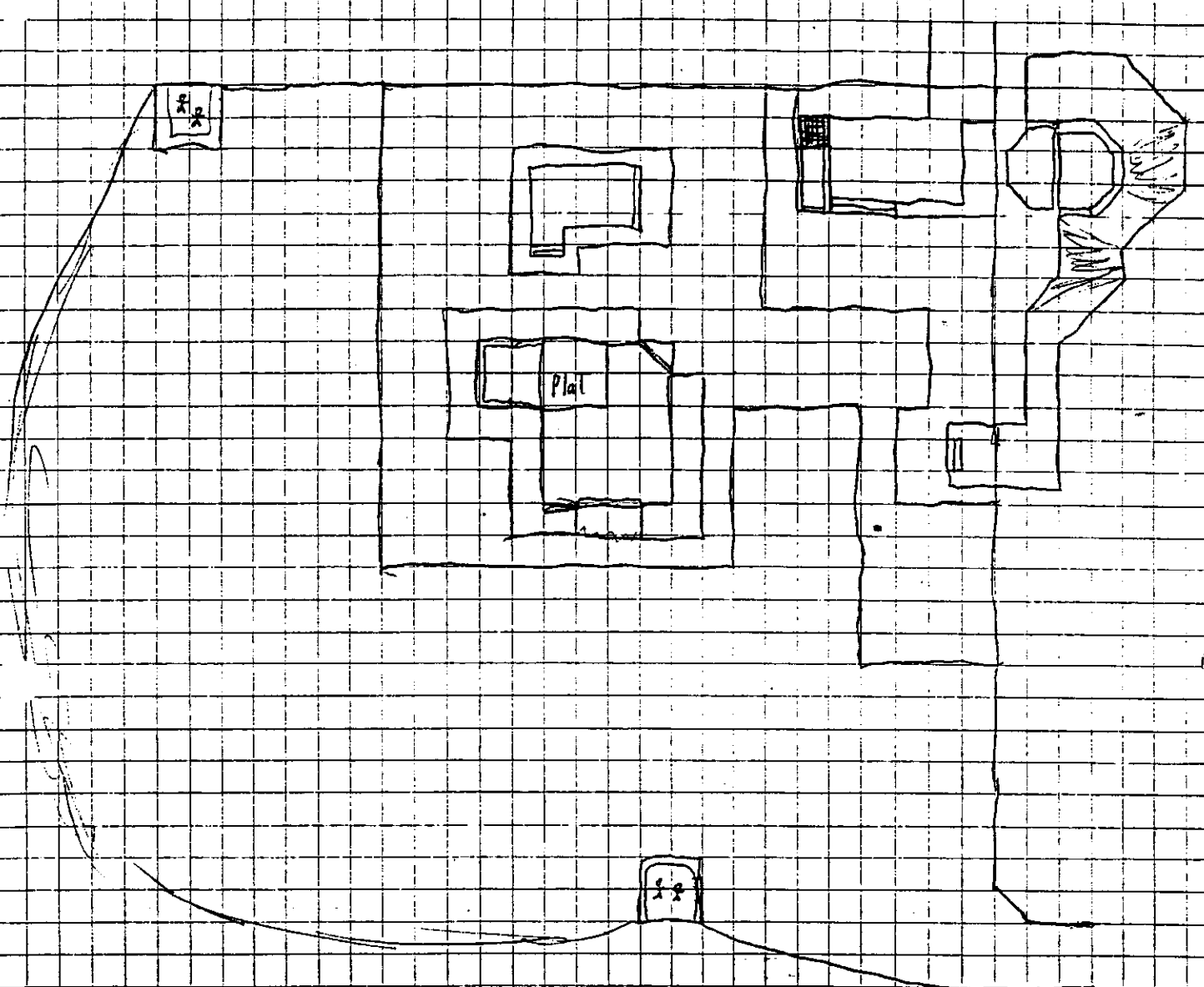

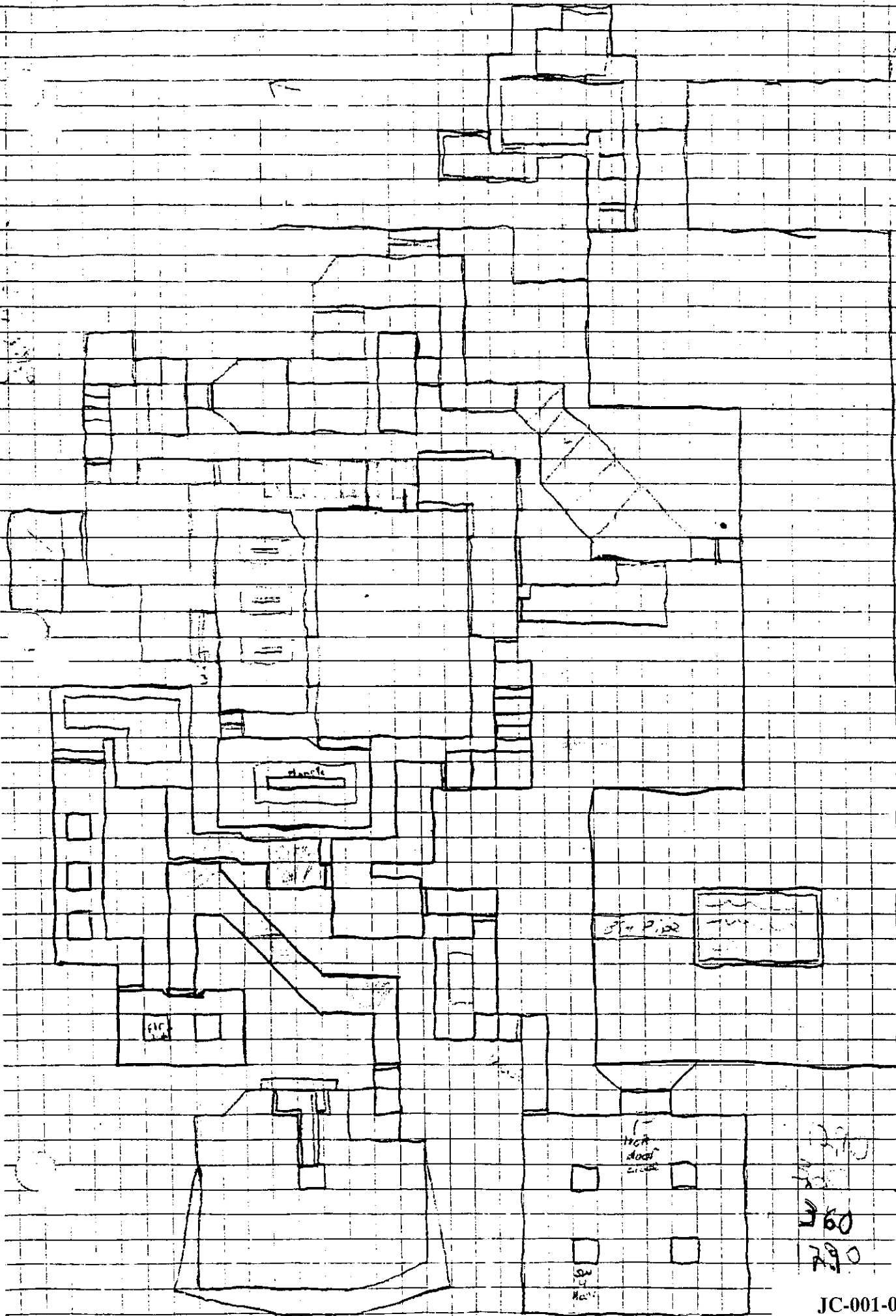



TimeTracker™
ACADEMIC 97-98

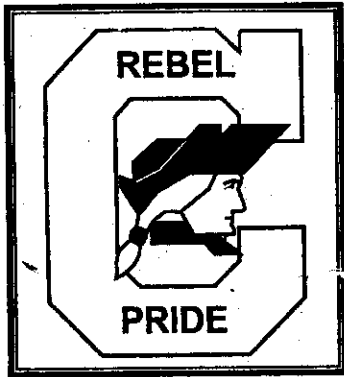

Columbine High School

"Stretch for Excellence"

6201 South Pierce Street
Littleton, Colorado 80123

Attendance - 982-4410
Bulletin Board - 982-4410
Counseling - 982-4426
FAX Number - 982-4401
Main Office - 982-4400

School Mascot: Rebels

Colors: Silver and Blue

School Motto: Stretch for Excellence

COLUMBINE HIGH SCHOOL ADMINISTRATIVE STAFF

Principal:

Frank DeAngelis

Assistant Principals:

Kevin Land - Athletic Director

Karen Studenka - Curriculum and Instruction

Pat Patrick - Activities Director

Dean of Students:

Peter Horvath - 9th & 12th grade Attendance & Discipline

Chris Mikesell - 10th & 11th grade Attendance & Discipline

At Columbine High School we will Teach, Learn and Model life skills and attitudes that prepare us to:

- ◆ Work with People,
- ◆ Prepare for Change,
- ◆ Think Critically,
- ◆ Act Responsibly, and
- ◆ Live in Harmony with Others and with Our Environment

This TimeTracker Belongs to:

Name _____

Address _____

City/State/Zip _____

Phone # _____

1997-1998 DAILY BELL SCHEDULES

REGULAR SCHEDULE

Period 1	7:30-8:20	
Period 2	8:25-9:20	
Period 3	9:25-10:15	
Period 4	10:20-11:10	
Period 5	11:15-11:45	Lunch A
	12:10-12:40	Lunch B
	11:15-12:05	Class
	11:50-12:40	Class
Period 6	12:45-1:35	
Period 7	1:40-2:30	

THURSDAY SCHEDULE

Period 1	8:10-8:55	
Period 2	9:00-9:45	
Period 3	9:50-10:35	
Period 4	10:40-11:25	
Period 5	11:30-12:00	Lunch A
	12:20-12:50	Lunch B
	12:05-12:50	Class
	11:30-12:15	Class
Period 6	12:55-1:40	
Period 7	1:45-2:30	

LONG ASSEMBLY SCHEDULE

(65 MINUTES)

Period 1	7:30-8:10	
Period 2	8:15-9:00	
ASSEMBLY	9:05-10:10	
Period 3	10:15-10:55	
Period 4	11:00-11:40	
Period 5	11:45-12:15	Lunch A
	12:30-1:00	Lunch B
	11:45-12:25	Class
	12:20-1:00	Class
Period 6	1:05-1:45	
Period 7	1:50-2:30	

SHORT ASSEMBLY SCHEDULE

(30 MINUTES)

Period 1	7:30-8:15	
Period 2	8:20-9:10	
ASSEMBLY	9:15-9:45	
Period 3	9:50-10:35	
Period 4	10:40-11:25	
Period 5	11:30-12:00	Lunch A
	12:20-12:50	Lunch B
	11:30-12:15	Class
	12:05-12:50	Class
Period 6	12:55-1:40	
Period 7	1:45-2:30	

<u>LUNCH A</u>	<u>LUNCH B</u>
Language Arts	Art
Math	Business
Social Studies	Foreign Language
Tech. Arts	Life Management
	Music
	P.E.
	Science

1997-1998 IMPORTANT DATES

AUGUST

- 13..... Senior/Junior Registration
- 14..... Sophomore/Freshman Registration
- 14..... New Student Orientation
- 13-18 Schedule Change Requests
- 18..... Last Day for Schedule Change
- 18..... Teachers Report
- 20..... Fresh/New Students Pick Up Schedules
- 20..... Fresh/New Students Orientation
- 20..... 1st Day of Classes, Semester 1
- 28..... School Picture Make-Up Day
- 28..... Back-To-School Night
- 29..... Vision/Hearing Screening

SEPTEMBER

- 1..... Labor Day - NO SCHOOL
- 15-20 Homecoming Week
- 19..... Homecoming Game
- 20..... Homecoming Dance

OCTOBER

- 3..... End Six Weeks Grading Period
- 8..... Retakes for Students and Faculty
- 8..... Report Cards in 2nd hr. Classes
- 14-15 PLAN Test - Sophomores
- 14-15 Parent/Teacher Conferences
- 17..... NO SCHOOL
- 20-31 Registration Semester Two

NOVEMBER

- 14..... End Six Weeks Grading Period
- 19..... Report Cards in 2nd hr. Classes
- 27-28 Thanksgiving Holiday - NO SCHOOL

DECEMBER

- 16..... Receive 2nd Semester Schedules
- 17,18,19 - JAN 6..... Schedule Change Requests
- 17-18 Final Exams for Semester 1
- 19 Make-up Day for Semester 1
- 19..... End of 1st Semester Grading Period

JANUARY

- 5..... Teachers Report-Non Student Contact Day
- 6..... First Day of Classes, Semester 2
- 6..... Schedules in Cafeteria
- 6..... Report Cards in Upper Commons
- 19..... Martin Luther King Day - NO SCHOOL
- 26-28 Recognition Breakfast

FEBRUARY

- 2-6 Registration 8th Grade - Ken Caryl
- 3..... 8th Grade Parent Meeting
- 13..... Columbine Area Inservice - NO SCHOOL
- 16..... Presidents Birthday - NO SCHOOL
- 20..... End Six Weeks Grading Period
- 25..... Report Cards in 2nd hr. classes
- 23-Mar 6 Registration 1998-99 (Gr. 9,10,11)

MARCH

- TBA..... Senior Assembly/Class Picture
- 12..... Parent/Teacher Conferences
- 13..... NO SCHOOL
- 16-20 Spring Break

APRIL

- 17..... End Six Weeks Grading Period
- 18..... Prom
- 22..... Report Cards in 2nd hr. Classes
- TBA..... Caps & Gown Distribution

MAY

- 13-14 Senior Finals
- 15..... Seniors Make-Up Day
- 22..... Class Day
- 23..... Graduation
- 25..... Memorial Day - NO SCHOOL
- 27-28 Finals
- 29..... Make-Up Day for Sem. 2
- 29..... Last Day of School

TABLE OF CONTENTS

1997-1998 DAILY BELL SCHEDULES	1
1997-1998 IMPORTANT DATES	2
ACADEMIC INFORMATION	3
Counseling.....	3
High School Graduation Requirements	4
College Admission.....	4
Important Testing Dates	4
Class Drops/Schedule Changes	5
Withdrawal from School.....	5
GENERAL INFORMATION.....	5
Lockers.....	5
Parking Lot Privileges.....	5
Student Parking Policy.....	5
Clement Park.....	5
Student Identification.....	5
Office information.....	6
Financial Office.....	6
SERVICES	6
Columbine High School Library Media Center.....	6
School Clinic	6
Food Services.....	7
ATTENDANCE.....	7
STUDENT CONDUCT GUIDELINES	9
Personal Conduct	9
School Appearance and Property	9
CLUBS AND ORGANIZATIONS.....	10
Art Club	10
Color Guard (Flag Team)	10
DECA - Distributive Education Clubs of America.....	10
Drama Club/Thespians.....	10
FBLA-Future Business Leaders of America ...	10
FCCLA (Family, Career & Community Leaders of America)	10
Forensics	10
Key Club	11
National Honor Society	11
Senate and Student Body Officers.....	11
Spirit Squads	11
Columbine Courier	11
Rebelations.....	12
Close-Up.....	12
Talent Show	12
PARENT INVOLVEMENT.....	12
Band Booster Club	12
Booster Club	13

Parent-Teacher-Student Association.....	13
Columbine Accountability Committee.....	13
Post Graduate Volunteers.....	13
ATHLETICS.....	13
Columbine High School Athletic Program.....	13
Training Rule Contract	13
Academic Eligibility.....	14
Varsity and Sub-Varsity Sports.....	14

ACADEMIC INFORMATION

COUNSELING

The Columbine Counselors provide a variety of services to students. Each counselor at CHS will participate in personal/social counseling, registration and academic advising, processing of college and scholarship applications, and provide input to students, teachers and parents regarding special needs. Specific services offered by the counselors and each counselor's part of the alphabet are listed below.

RYAN COLLINS

(A-CL)

Peer Counseling

JOE CUNNINGHAM

(CO-G)

College Counseling
Coordinator
NCAA Clearinghouse
Liaison

BRAD BUTTS (H-K)

Department Chairperson
Alternative School
Liaison(Littleton
Options)

SUSAN PETERS (L-N)

Career Counseling/
Post Grad Center
Coordinator
9th Grade/New Student
Transition Coordinator
Group Counseling/Support
Monitor

KEN HOLDEN

(O-SM)

Peer Counseling

College Counseling
Coordinator
NCAA Clearinghouse
Liaison
Outdoor Lab

TBA (SN-Z)

District Testing/AP
Coordinator
Warren Tech Liaison
Military Liaison

HIGH SCHOOL GRADUATION REQUIREMENTS

As a student at Columbine High School, you should constantly be aware of the course requirements that are set forth as policies of the Jefferson County Board of Education. With these in mind, it will be easier for you to determine what courses must be taken as you progress toward graduation.

ALL CREDITS EARNED IN GRADES 9-12 ARE COLLECTIVELY COUNTED TOWARD HIGH SCHOOL GRADUATION.

Students must complete the following course requirements in grades 9-12:

Requirements for a High School Diploma:

- Language Arts..... 4.0 units/credits
 - Social Studies..... 3.0 units/credits
 - Mathematics..... 2.0 units/credits
 - Physical Education5 units/credits
 - Science..... 2.0 units/credits
 - Elective Courses..... 10.5 units/credits
- TOTAL UNITS = 22.0

Specific Ninth Grade Requirements:

- Language Arts..... 1.0 unit
- Mathematics..... 1.0 unit
- Science..... 1.0 unit
- Social Studies..... 0.5 unit
- Elective Courses..... 2.5 units

COLLEGE ADMISSION

Since many of the private schools, as well as some of the state-supported institutions located both in and outside of Colorado, have stringent entrance requirements, it is advisable for you to begin your planning for college admission early in your junior year. Admission representatives from 100 colleges and universities visit Columbine High School each year. They are available to visit with students and parents. The counseling office posts lists of these visiting representatives and when they are scheduled to visit. It is advisable for you to meet with them to get academic and financial aid information about their institutions.

IMPORTANT TESTING DATES:

ACT Testing and Registration Dates

Test Date	Reg. Deadline	Late Reg. Deadline
Oct. 25, 1997	Sept. 22, 1997	Oct. 3, 1997
13, 1997	Nov. 10, 1997	Nov. 21, 1997
Feb. 7, 1998	Jan. 5, 1998	Jan. 16, 1998
April 4, 1998	March 2, 1998	March 13, 1998
June 13, 1998	May 11, 1998	May 22, 1998

SAT Testing and Registration Dates

Test Date	Reg. Deadline	Late Reg. Deadline
(SAT I & II)		
Oct. 4, 1997	Sept. 9, 1997	Sept. 13, 1997
Nov. 1, 1997	Sept. 26, 1997	Oct. 8, 1997
Dec. 6, 1997	Oct. 30, 1997	Nov. 14, 1997
Jan. 24, 1998	Dec. 19, 1997	Dec. 30, 1997
March 28, 1998	Feb. 20, 1998	March 4, 1998
(SAT I only)		
May 2, 1998	March 26, 1998	April 10, 1998
June 6, 1998	April 30, 1998	May 15, 1998

PSAT/NMSQT Testing Dates

- October 18, 1997 (Saturday)
- October 14, 1997 (Tuesday - alternate test date for school related conflicts ONLY)

Advanced Placement Testing

May 11-22, 1998

In-State College Nights

Oct. 20, 1997	
Arvada West High School	7:00 p.m.
Oct. 21, 1997	
Green Mountain High School	7:00 p.m.
Oct. 29, 1997	
Dakota Ridge High School	7:00 p.m.

Out-Of-State College Nights

Oct. 15, 1997	
Wheat Ridge High School	6:30 p.m.
Oct. 16, 1997	
Thomas Jefferson High School	6:30 p.m.

College Information Metro Workshop

Oct. 19, 1997	
Cherry Creek High School	10a.m.-3 p.m.

Class Drops/Schedule Changes:

Schedule changes will only be made for sound educational reasons with the Administration making the final determination. The dates for changes will be included in registration materials.

A class officially dropped the first two weeks of a semester will be reported as a "WP" or "WF" on a student's transcript.

Thereafter, a student will be given a grade of "F" when dropped from a class. Failure to attend a class is not an official drop, and will result in an "F".

Withdrawal from School:

Students withdrawing from Columbine Senior must report to the Registrar in the Counseling Center with written permission from a parent or legal guardian stating the reason for withdrawal and the new address, if applicable. All financial obligations must be cleared before records will be sent to another school.

GENERAL INFORMATION

Lockers:

A locker will be issued to each new C.H.S. student who wishes to utilize such a space. The locker becomes the student's responsibility but does not become the student's personal possession, and therefore may be searched. Lockers will be issued to students at registration time. It is not recommended that valuable items be left in lockers. Students are permitted to occupy only the locker that has been assigned.

Parking Lot Privileges:

Due to limited parking spaces, only juniors and seniors will be allowed to park on campus in the student parking lot. No students are allowed to park in the staff/public lot in front of the school.

Any motorized vehicle parked on school property must have a Columbine High School parking permit. Improperly parked and/or unregistered vehicles will be subject to ~~being~~ *being* and/or towing without warning.

Student Parking Policy:

1. All student cars, which are parked on school property, must be registered with the campus supervisor. The permit can be transferred easily to another vehicle owned by the student. Giving a permit to another student will result in revocation of parking privileges.
2. Students using the south lot must park within the yellow ~~designated~~ *designated* lines.
3. Students may not park along the sides of either the entrance or exit ramps.
4. Violations of this policy will be grounds for the issuance of parking violation notice and will subject the ~~student~~ *student* to a fine with the fine doubled in the case of an unregistered vehicle. An unregistered or improperly parked vehicle may be towed without advance notice. Driving privileges may be revoked or students suspended for continued ~~flagrant~~ *flagrant* violations.

Clement Park:

Clement Park will be closed to students until after 6th hour. Students may walk through the park to get to cars, but there should be no loitering or congregating. *even though that's what Parks are for...*

Student Identification:

New students will receive an I.D. card at the beginning of the school year. The picture taken during registration will appear on the card. Since it is necessary to present the I.D. card at registration and at most school functions, students are required to carry their card at all times, and will show the ID upon request of CHS staff. There is no charge for the first I.D. card. If a card is lost, a replacement can be obtained at registration for \$3.00 fee.

MEMORY

Once information is stored in your memory it is never forgotten. Many times we think we have forgotten something when in fact we never really stored the information in our memory. We can improve our memory by learning to store information more efficiently.

- Organize information from general to specific. Take time to preview material to get a feel for the general idea of the information.
- Use your imagination to create visual pictures of abstract concepts. *—help*
- Recite information out loud then repeat it until you know it. *Recite, Recite, Recite*
- Write it down. *Recite, Recite, Recite*
- Even information that we store in long-term memory can be difficult to recall if we don't use it regularly. To remember something you need to come in contact with it as often as possible—read it...write it...speak it...listen to it...and apply it.

- Take the time to make sure your notes are neat. Leave large margins so you can add to your notes later.
- Use symbols to highlight information: brackets, parentheses, circles, stars, arrows, underline, equal signs, question marks, etc.
- Record your notes in an outline form to see relationships between ideas. If you are having trouble following the sequence of a lecture, write out your notes in informal paragraphs. As you review your notes, you will be able to recognize the major points and create an outline.

STUDYING

- Become aware of your best time of day to study—when you are the most alert and focused.
- Select a place where you can concentrate for an extended period of time without distraction.
- Develop a schedule that allows you to review material on a daily basis. It is especially important to review material within 24 hours. This helps move information from short-term to long-term memory.
- As you review class material, determine the important ideas and major points of each section. If your notes are unorganized you may want to rewrite them in an outline form. By rewriting your notes you are forcing yourself to review the material.



- Take regular breaks when you study for extended periods of time. Stand up, stretch, get a drink of water, etc. Don't let these breaks exceed 5 to 10 minutes.
- Study difficult subjects first. The subjects we find difficult often require more concentration and energy. If you are continually avoiding a subject, seek out a teacher or friend to help you with the material.
- Take advantage of your spare time. Time between classes, before appointments, or while waiting for a ride adds up fast. Prepare short study tasks for these situations.
- Do not depend on last minute cramming to prepare for tests. It is better to combine several weeks of regular study periods with more extensive review as the test date nears.



- Be sure you read and understand all of the directions of the examination.
- Skim the entire test and budget your time wisely. Do not spend too much time on any one question.
- Jot down formulas, equations or other information you know you'll need, but might forget, in the margins of the test.
- Start at the beginning and answer the easy questions first.
- Look for answers in other test questions. Sometimes one question will include the answer to another. Other questions may also stimulate your memory.
- Read multiple choice and true/false questions carefully. Trust your first instinct.
- If you finish early, be sure to read over the entire test again to make sure that you have answered all of the questions and that all of your answers are legible.
- When you get your tests back, be sure to correct any incorrect answers. Doing this will help store the correct information in your memory.

PARTS OF SPEECH

Noun

Names a person, place, thing, concept, or quality. There are two basic types of nouns:

- Common - *human, soldier, college, book, faith* (name general classes or categories)
- Proper - *Abraham Lincoln, U.S. Army, University of Colorado, Alice in Wonderland, Christianity* (name specific people, places, things and must be capitalized)

W

(noun substitute)

Used as a substitute for a noun (the noun for which a pronoun substitutes is called its antecedent). Pronouns have three cases: subjective (subject of the sentence); objective (object of the verb or preposition); and possessive (expresses ownership). Pronouns fall into several different categories:

- Personal - *I, me, my, mine; we, us, our, ours* (1st person); *you, your, yours* (2nd person); *he, him, his; she, her, hers; it, its; they, them, their, theirs* (3rd person)
- Demonstrative - *this, these; that, those*
- Relative - *who* (or *whom*), *which*, and *that*
- Interrogative - *who* (or *whom*), *what*, and *which*
- Indefinite - *all, any, another, anyone, anything, both, each, either, everybody, few, many, most, much, neither, nobody, none, several, some, and such*
- Reflexive/Intensive - *myself, yourself, himself, herself, itself, oneself, ourselves, yourselves, and themselves* (always ends with -self or -selves)
- Reciprocal - *one another, and each other*

Verb

Describes an action or a state of being. It also identifies the time of the activity (past, present, future).

She *threw* the ball. (past)

We *need* your help today. (present)

You *will enjoy* the dance. (future)

Adjective

Describes a noun or pronoun by pointing out one of its qualities. Adjectives are usually placed just before the words they describe.

There were *four red* chairs in the *large* room. It was an *awkward* situation for the *five* guests.

Adverb

Modifies the action or condition expressed by a verb, adjective, or another adverb. They specify how, when, where, or to what degree. Adverbs are often formed by adding -ly to an adjective.

Gail was *extremely* upset. She ran out of the building *immediately*.

Conjunction

Connects words, phrases, or clauses together. Types of conjunctions:

- Coordinating - *and, but, or, for, nor, yet, and so* (joins similar sentence elements)

My favorite subjects are English, science, *and* art.

- Correlative - *either/or, neither/nor, not only/but also, both/and, and whether/or*

(used in pairs, joins similar sentence elements)

You can *either* go to the movie *or* the park tonight.

- Subordinating - *so, although, after, because, if, where, than, since, as, unless, before, that, though, when, and whereas* (joins two clauses, normally a dependent one to an independent one)

The geography test was easy *because* I was prepared.

Preposition

Indicates the relationship of a noun or pronoun to another word in a sentence.

- Direction - *to, into, across, toward, up, down*
- Location - *at, in, on, under, over, beside, among, by, between, through*

- Time - *before, after, during, until, since*

- Figurative Location - *for, against, with*

She was standing *near* her locker when they ran *down* the hall.

Interjection

A word or phrase used independently to express strong emotion, surprise, or to summon attention (frequently followed by an exclamation mark).

Hey! Where are you going? I need your help now.

PUNCTUATION RULES

Semicolon ;

Use the semicolon between main clauses not linked by a coordinating conjunction (and, but, for, or, nor, so, yet).

Don't open the door; the floor is still wet.

Use the semicolon to separate a series of items which themselves contain commas.

At our garage sale we sold old plates, spoons, and glasses; used sporting goods; rusty garden tools; and an assortment of toys.

Colon :

The colon may direct attention to an explanation or summary, a series, or a quotation.

She considered three colleges: CU, CSU, and UNC.

Use the colon between figures in spiritual and time references and between titles and subtitles.

John 3:16 2:30 P.M. Goals: Why You Need Them.

Hyphen -

Hyphenate words to express the idea of a unit and to avoid ambiguity.

hand-fed double-parked

Use the hyphen to join two or more words serving as a single adjective before a noun.

a well-known doctor ten-year-old car

Use the hyphen with spelled out compound numbers.

from twenty-one to twenty-nine

Use the hyphen with the prefixes *ex-* (former), *self-*, *all-*; with the suffix *-elect*; and between a prefix and a capitalized word.

ex-wife self-help mayor-elect mid-September

Also use the hyphen for the division of words at the end of a line. Make such divisions only between syllables and according to standard practice. Avoid dividing words on two consecutive lines.

Apostrophe '

Use the apostrophe to indicate the possessive case of nouns and indefinite pronouns.

Terry's car a day's work everybody's friend

For plural nouns ending in *s*, add only the apostrophe.

five dollars' worth the Jones' house

Use the apostrophe to mark omissions in contractions and in numbers.

didn't he'll they're class of '97

Do not use the apostrophe with the pronouns *his*, *hers*, *its*, *ours*, *yours*, *theirs*, or *whose* or with plural nouns not in the possessive case.

Slash /

Use the slash between terms to indicate that either term is applicable.

If the student achieves perfect attendance for the year, he/she will receive the school award packet.

Quotation Marks " "

Use quotation marks for direct quotations and in all dialogue. Use single quotation marks to enclose a quotation within a quotation.

He said, "I have the answer." (direct quotation)

"The dog belongs to Amy," he said. (dialogue)

"She called my idea a 'long shot,'" he said. (quotation within a quotation)

Use quotation marks for minor titles (short stories, essays, short poems, songs, episodes of a television series, articles in periodicals) and subdivisions of books. **Italicize or underline the titles of books, periodicals, newspapers, movies, and paintings.**

Her poem "River," was the teacher's favorite.

Using various marks of punctuation with quoted words:

- Place the period and the comma within the quotation marks.
- Place the colon and semicolon outside the quotation marks.
- Place the question mark, the exclamation point, and the dash within the quotation marks when they apply only to the quoted matter. Place them outside when they do not.

Parentheses ()

Use parentheses to set off supplementary or illustrative matter.

You could see that the bird's feathers were banded in several colors (red, blue, yellow) when he was flying.

Parentheses are also used to enclose figures or letters when used for enumeration.

The National Student Association (NSA) has 26,000 members.

SPELLING RULES *5/26/06*

↳ DROPPING OR RETAINING A FINAL SILENT E

- Drop the -e before a suffix beginning with a vowel:
age-aging desire-desirable fame-famous
- Retain the -e before a suffix beginning with a consonant:
care-careful safe-safety manage-managemen

Exceptions: *acreage, mileage, argument, trully, whally*

- To keep the sound of soft -ce or -ge do not drop the spe... before -able or -ous:

class is an... changeable courageous outrageous

↳ DROPPING A FINAL CONSONANT BEFORE A SUFFIX

- Drop a final consonant before a suffix when the consonant is preceded by a vowel if both (1) the consonant ends a stressed syllable or a one-syllable word and (2) the consonant is preceded by a single vowel

Words stressed on last syllable:

begin-beginning occur-occurrence

One-syllable words:

hid-hidden shop-shoppers

↳ CHANGING OR RETAINING A FINAL Y BEFORE A SUFFIX

- Change the -y to i before suffixes, except -ing:
apply-applies, applied, appliance OR applying study-studies, studied OR studying
- Exceptions: Do not change the y before -s or -ed in verbs ending in y preceded by a vowel:
stay, stays, stayed.

↳ RETAINING A FINAL L BEFORE -LY

- Do not drop a final l when you add -ly:
real-really usual-usually formal-formally

↳ ADDING -S TO FORM THE PLURAL OF NOUNS

- Form the plural of most nouns by adding -s to the singular:
two boys many nations
- Add -es to singular nouns ending in s, ch, sh, or x:
loves, approach-approaches, ash-ashes tax-taxes
- Add -es to singular nouns ending in y preceded by a consonant, after changing the y to i:
company-companies ninety-nineties industry-industries

↳ WHEN TO USE FI AND IE

- When the sound is e (ee), write ie (except after c, in which case write ei):
field chief yield deceive-perceive conceit (after c)
 - When the sound is other than e (ee), usually write ei:
foreign height weigh
- "I before E except after C - Or when sounded as A"

THESE ARE GENERAL RULES - THERE ARE ALWAYS EXCEPTIONS! KEEP A RECORD OF WORDS YOU MISPELL AND REVIEW THE LIST PERIODICALLY.



Frequently Misspelled Words



accommodate	controversy	height	performance	profession	succession
achievement	controversial	interest	personal	prominent	surprise
acquire	definitely	its, it's	personnel	pursue	technique
all right	definition	led	possession	quiet	than
among	define	lose	possible	receive	then
apparent	describe	losing	practical	receiving	their
argument	description	marriage	precede	recommend	there
arguing	disastrous	mere	prejudice	referring	they're
belief	effect	necessary	prepare	repetition	thorough
believe	embarrass	occasion	prevalent	rhythm	to, too, two
beneficial	environment	occurred	principal	sense	transferred
benefited	exaggerate	occurring	principle	separate	unnecessary
category	existence	occurrence	privilege	separation	villain
coming	existent	opinion	probably	shining	woman
comparative	experience	opportunity	proceed	similar	write
conscious	explanation	paid	procedure	studying	writing
	fascinate	particular	professor	succeed	

MEASUREMENTS

LENGTH

12 inches (in or ").....	equals 1 foot (ft or')
3 feet.....	equals 1 yard (yd)
1760 yards.....	equals 1 mile (mi)
1.15 miles.....	equals 1 nautical mile
3 miles.....	equals 1 league

VOLUME

3 teaspoons (tsp or t).....	equals 1 tablespoon (tbl or T)
16 tablespoons.....	equals 1 cup (c)
2 cups.....	equals 1 pint (pt)
2 pints.....	equals 1 quart (qt)
4 quarts.....	equals 1 gallon (gal)

WEIGHT

16 ounces (oz).....	equals 1 pound (lb)
2000 pounds.....	equals 1 ton

AREA

4860 sq. yards.....	equals 1 acre
640 acres.....	equals 1 sq. mile

CONVERSION TABLE

WHEN YOU KNOW	MULTIPLY BY	TO FIND
inches.....	2.54	centimeters
feet.....	30.48	centimeters
yards.....	0.9144	meters
miles.....	1.609	kilometers
teaspoons.....	4.9289	milliliters
tablespoons.....	14.787	milliliters
cups.....	0.2366	liters
pints.....	0.4732	liters
quarts.....	0.9464	liters
gallons.....	3.7854	liters
pounds.....	0.4536	kilograms
tons.....	0.9072	metric ton
centimeters.....	0.3937	inches
meters.....	1.0936	yards
kilometers.....	0.6214	miles
milliliters.....	0.0338	fluid ounces
liters.....	1.057	quarts
liters.....	0.2642	gallons
grams.....	0.0353	ounces
kilograms.....	2.2046	pounds
metric ton.....	1.1023	ton

DECIMAL EQUIVALENTS OF COMMON FRACTIONS

1/2.....	0.5000	3/11.....	0.2727
1/3.....	0.3333	4/5.....	0.8000
1/4.....	0.2500	4/7.....	0.5714
1/5.....	0.2000	4/9.....	0.4444
1/6.....	0.1667	4/11.....	0.3636
1/7.....	0.1429	5/6.....	0.8333
1/8.....	0.1250	5/7.....	0.7143
1/9.....	0.1111	5/8.....	0.6250
1/10.....	0.1000	5/9.....	0.5556
1/11.....	0.0909	5/11.....	0.4545
1/12.....	0.0833	5/12.....	0.4167
1/16.....	0.0625	6/7.....	0.8571
1/32.....	0.0313	6/11.....	0.5455
1/64.....	0.0156	7/8.....	0.8750
2/3.....	0.6667	7/9.....	0.7778
2/5.....	0.4000	7/10.....	0.7000
2/7.....	0.2857	7/11.....	0.6364
2/9.....	0.2222	7/12.....	0.5833
2/11.....	0.1818	8/9.....	0.8889
3/4.....	0.7500	8/11.....	0.7273
3/5.....	0.6000	9/10.....	0.9000
3/7.....	0.4286	9/11.....	0.8182
3/8.....	0.3750	10/11.....	0.9091
3/10.....	0.3000	11/12.....	0.9167

METRIC MEASUREMENTS

	LENGTH	VOLUME	WEIGHT
1000	kilometer (km)	kiloliter (kl)	kilogram (kg)
100	hectometer (hm)	hectoliter (dal)	hectogram (dag)
10	decameter (dam)	decaliter (dal)	decagram (dag)
1	meter (m)	liter (l)	gram (g)
1/10	decimeter (dm)	deciliter (dl)	decigram (dg)
1/100	centimeter (cm)	centiliter (cl)	centigram (cg)
1/1000	millimeter (mm)	milliliter (ml)	milligram (mg)

TEMPERATURE CONVERSIONS

Fahrenheit to Celsius: $C = (F - 32) \div 5 \times 9$		
Celsius to Fahrenheit: $F = (C \times 9 \div 5) + 32$		
Celsius to Kelvin: $K = C + 273.15$		
Water boils.....	212°F	100°C
Body temperature.....	98.6°F	37°C
Room temperature.....	72°F	22°C
Water freezes.....	32°F	0°C
Absolute zero.....	459.67°F	273.15°C

*lowest possible temperature

Angles

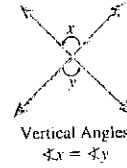
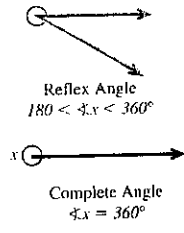
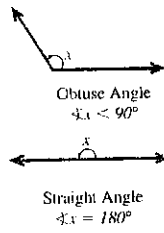
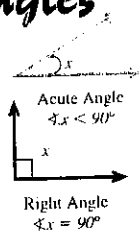

Triangles



Equilateral Triangle
A triangle with three equal sides and three equal angles of 60° .

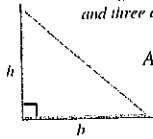

Right Triangle
A triangle with one 90° angle. The side opposite the right angle is called the hypotenuse.

Area = $1/2 bh$

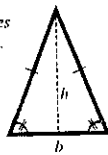

Isosceles Triangle
A triangle with two equal sides and two equal angles. Angles opposite the equal sides are always equal.

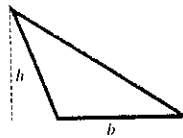

Scalene Triangle
A triangle with no equal sides and no equal angles.

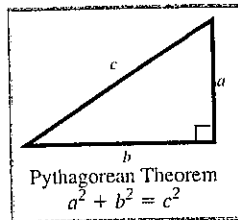

Pythagorean Theorem
 $a^2 + b^2 = c^2$

Congruency Cases

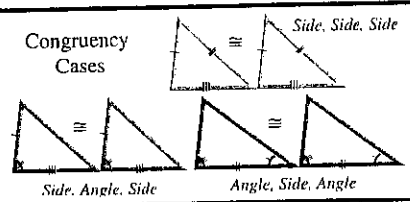

Quadrilaterals

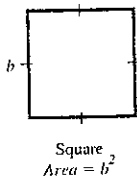

Square
Area = b^2

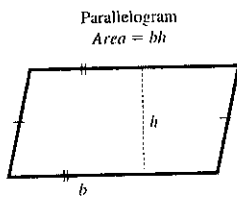

Parallelogram
Area = bh

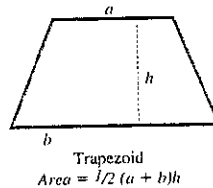

Trapezoid
Area = $1/2 (a + b)h$

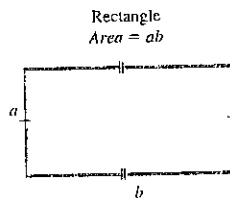

Rectangle
Area = ab

Solids



Cube
Volume = s^3
Total Surface Area = $6s^2$

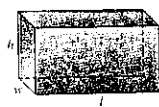

Rectangular Prism
Volume = lwh
Total Surface Area = $2lw + 2wh + 2lh$

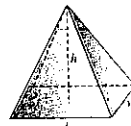

Pyramid
Volume = $1/3 lh^2$

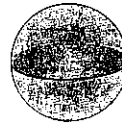

Sphere
Volume = $4/3 \pi r^3$
Total Surface Area = $4\pi r^2$



Cone
Volume = $1/3 \pi r^2 h$
Lateral Surface Area = $\pi r \sqrt{r^2 + h^2}$



Cylinder
Volume = $\pi r^2 h$
Lateral Surface Area = $2\pi rh$

Circles

Circumference = $2\pi r$
Area = πr^2

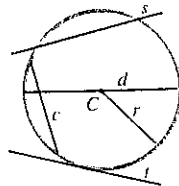

C = center
d = diameter
r = radius
s = secant
t = tangent
c = chord

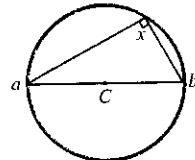

$\angle x = 90^\circ$
ab is the diameter

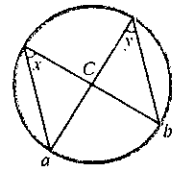

$\angle x = \angle y$
angles subtended on the same arc ab

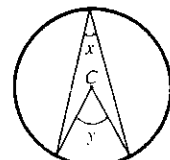

$2\angle x = \angle y$

FRACTIONS

$$\frac{a}{b} + \frac{c}{d} = \frac{ad + bc}{bd}$$

$$\frac{a}{b} - \frac{c}{d} = \frac{ad - bc}{bd}$$

$$\frac{a}{b} \times \frac{c}{d} = \frac{ac}{bd}$$

$$\frac{a}{b} \div \frac{c}{d} = \frac{ad}{bc}$$

EXPONENTS

$$x^0 = 1$$

$$x^1 = x$$

$$x^a = x \cdot x \cdot x \dots (\text{a times})$$

$$x^{-a} = 1/x^a$$

$$x^a \cdot x^b = x^{a+b}$$

$$(x \div y)^b = x^b \div y^b$$

$$x^a \div x^b = x^{a-b}$$

$$(x^a)^b = x^{ab}$$

$$x^{1/a} = \sqrt[a]{x}$$

$$x^a \cdot y^a = (xy)^a$$

$$x^{a/b} = \sqrt[b]{x^a} = (\sqrt[b]{x})^a$$

LOGARITHMS

$$\text{Log}_a x = n \Leftrightarrow x = a^n \text{ (Log to the base } a)$$

$$\text{Log} x = n \Leftrightarrow x = 10^n \text{ (common Log)}$$

$$\text{Ln} x = n \Leftrightarrow x = e^n \text{ (natural Log)}$$

$$e = 2.71828\dots$$

$$\text{Log}_b(xy) = \text{Log}_b(x) + \text{Log}_b(y)$$

$$\text{Log}_b(x/y) = \text{Log}_b(x) - \text{Log}_b(y)$$

$$\text{Log}_b(x^a) = a \text{Log}_b x$$

$$\text{Log}_b(\sqrt[n]{x}) = 1/n \text{Log}_b x$$

POLYNOMIALS

$$a(b+c) = ab + ac$$

$$(a+b)^2 = a^2 + 2ab + b^2$$

$$a^2 - b^2 = (a-b)(a+b)$$

$$(a+b)^3 = a^3 + 3a^2b + 3ab^2 + b^3$$

$$a^3 - b^3 = (a-b)(a^2 + ab + b^2)$$

$$(a+b+c)^2 = a^2 + b^2 + c^2 + 2ab + 2ac + 2bc$$

The Quadratic Formula - the solutions to:

$$ax^2 + bx + c = 0 \text{ are } x = \frac{-b \pm \sqrt{b^2 - 4ac}}{2a}$$

PHYSICS

$$\text{Net Force (N newtons)} = \text{mass} \cdot \text{acceleration}$$

$$\text{Momentum (kg} \cdot \text{m/s)} = \text{mass} \cdot \text{velocity}$$

$$\text{Work (J joules)} = \text{force} \cdot \text{distance}$$

$$\text{Density (g/cm}^3) = \frac{\text{mass}}{\text{volume}}$$

$$\text{Velocity (m/s)} = \frac{\text{distance}}{\text{time}}$$

$$\text{Power (W watts)} = \frac{\text{work}}{\text{time}}$$

$$\text{Specific gravity} = \frac{\text{density of substance}}{\text{density of water}}$$

$$\text{Acceleration (m/s}^2) = \frac{\text{final vel.} - \text{initial vel.}}{\text{time}}$$

TRIGONOMETRY

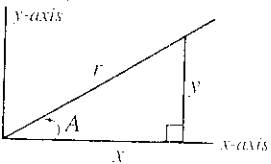

$$\sin A = y/r \text{ (opp./hyp.)}$$

$$\cos A = x/r \text{ (adj./hyp.)}$$

$$\tan A = y/x \text{ (opp./adj.)}$$

$$\csc A = r/y \text{ (hyp./opp.)}$$

$$\sec A = r/x \text{ (hyp./adj.)}$$

$$\cot A = x/y \text{ (adj./opp.)}$$

$$\sin(x \pm y) = \sin x \cos y \pm \cos x \sin y$$

$$\cos(x \pm y) = \cos x \cos y \mp \sin x \sin y$$

$$\sin(2x) = 2 \sin x \cos x$$

$$\tan(x \pm y) = \frac{\tan x \pm \tan y}{1 \mp \tan x \tan y}$$

$$\tan x = \sin x / \cos x$$

$$\cot x = \cos x / \sin x$$

$$\sin^2 x + \cos^2 x = 1$$

$$\cot x \pm 1 = \csc^2 x$$

$$\tan^2 x \mp 1 = \sec^2 x$$

$$\cos(2x) = \cos^2 x - \sin^2 x = 2\cos^2 x - 1 = 1 - 2\sin^2 x$$

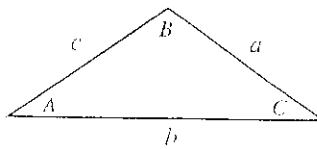

$$\text{Law of Sines: } \frac{a}{\sin A} = \frac{b}{\sin B} = \frac{c}{\sin C}$$

$$\text{Law of Cosines: } a^2 = b^2 + c^2 - 2bc \cos A$$

$$b^2 = a^2 + c^2 - 2ac \cos B$$

$$c^2 = a^2 + b^2 - 2ab \cos C$$

PERIODIC TABLE OF ELEMENTS

Noble Gases
18
VIIa

Nonmetals

Transition Metals

Alkali Earth Metals

Alkali Metals

Noble Gases

Group	1	2	3	4	5	6	7	8	9	10	11	12	13	14	15	16	17	18																																																																					
	Ia	IIa	IIIB	IVB	VB	VIB	VIIb	VIIIb			IB	IIB	IIIA	IVA	VA	VIA	VIIa	VIIIa																																																																					
Atomic Number ¹	3	4	11	12	13	14	15	16	17	18	19	20	21	22	23	24	25	26																																																																					
Relative Atomic Mass ²	1.00794	9.0122	44.9559	47.88	50.9415	51.9661	54.9380	55.847	58.9332	58.9332	58.9332	58.9332	55.847	58.9332	58.9332	58.9332	58.9332	58.9332																																																																					
Symbol ³	H	He	Li	Be	B	C	N	O	F	Ne	Na	Mg	Al	Si	P	S	Cl	Ar																																																																					
Name	Hydrogen	Helium	Lithium	Beryllium	Boron	Carbon	Nitrogen	Oxygen	Fluorine	Neon	Sodium	Magnesium	Aluminum	Silicon	Phosphorus	Sulfur	Chlorine	Argon																																																																					
Electron Configuration	1s ¹	1s ²	1s ² 2s ¹	1s ² 2s ²	1s ² 2s ² 2p ¹	1s ² 2s ² 2p ²	1s ² 2s ² 2p ³	1s ² 2s ² 2p ⁴	1s ² 2s ² 2p ⁵	1s ² 2s ² 2p ⁶	1s ² 3s ¹	1s ² 3s ²	1s ² 3s ² 3p ¹	1s ² 3s ² 3p ²	1s ² 3s ² 3p ³	1s ² 3s ² 3p ⁴	1s ² 3s ² 3p ⁵	1s ² 3s ² 3p ⁶																																																																					
33	34	35	36	37	38	39	40	41	42	43	44	45	46	47	48	49	50	51	52	53	54	55	56	57	58	59	60	61	62	63	64	65	66	67	68	69	70	71	72	73	74	75	76	77	78	79	80	81	82	83	84	85	86	87	88	89	90	91	92	93	94	95	96	97	98	99	100	101	102	103	104	105	106	107	108	109	110	111	112	113	114	115	116	117	118	119	120

Elements 107-109
Names and symbols have been suggested for the elements 107-109
These have yet to be approved by the IUPAC

¹ Atomic Number = Number of Protons
² Based upon carbon-12
() indicates most stable or best known isotope
³ Red Outline - synthetically prepared
Blue - gaseous Green - liquid at room temp.
Black - solid Purple - all isotopes radioactive

NUTRITION

The Food Guide Pyramid is an outline of what to eat each day based on the Dietary Guidelines for Americans. It is not a rigid prescription but a general guide that lets you choose a healthful diet that's right for you. Use the pyramid to help you eat better every day. Start with plenty of breads, cereals, rice, pasta, vegetables, and fruits. Add 2-3 servings from the milk and meat groups. Remember to go easy on fats, oils, and sweets—the food in the small tip of the pyramid.

Source: United States Department of Agriculture and the Food Labeling Education Information Center

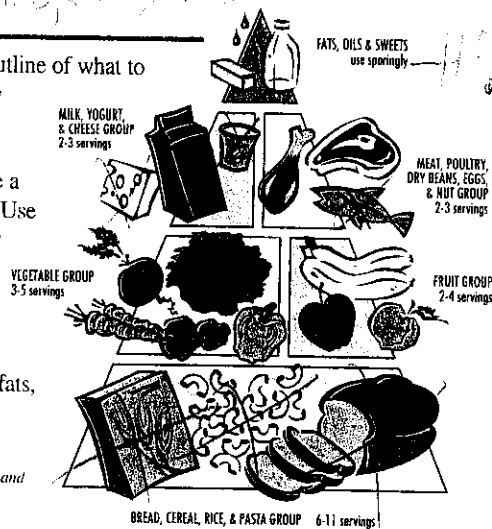

THE INTERNET AND THE WORLD WIDE WEB

The Internet has revolutionized the computer and communications world. It has world-wide broadcasting capability, is a mechanism for information dissemination, and is a medium for collaboration and interaction between individuals and their computers without regard for geographic location.

One of the fastest growing and most popular aspects of the Internet is the World Wide Web. The amount of data and sites to visit has grown at an explosive rate (see below). It has become a valuable source of information for professionals and novices alike.

Whether you're searching for a hard to find book, recent archeological studies, the latest sports news, or people with similar interests, you're sure to find something of interest. If you don't, why not make it available on your own web page!

Surf the Web!

Notable World Wide Web Sites:

- www.yahoo.com (Search Engine)
- www.usatoday.com
- www.apple.com
- www.microsoft.com
- www.chef.com (The Computer Network)
- www.redcross.org
- www.sportsline.com (CBS SportLine)
- www.si.edu (Smithsonian Institute)
- www.nationalgeographic.com
- www.nasa.gov
- mistral.culture.fr/louvre (Museum in France)
- lcweb.loc.gov (Library of Congress)
- www.amazon.com (Book Store)
- www.timetracker.com

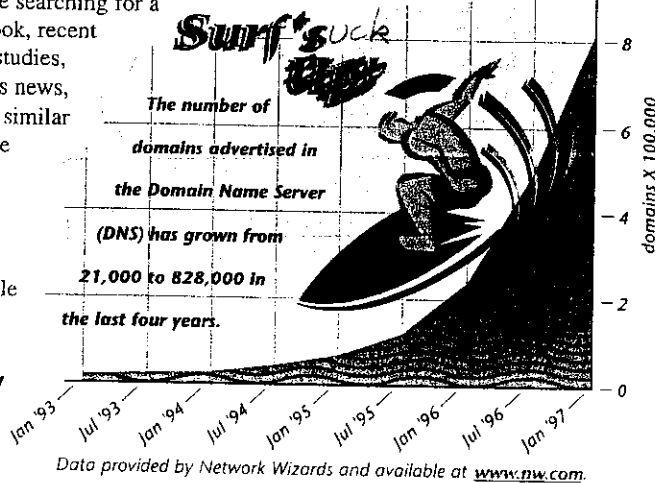

ENVIRONMENT

According to one study, Americans generate 230 million tons of refuse a year! That equates to 5.1 pounds per person, per day or about 1,900 pounds per year. This waste is filling up the landfills at an alarming rate. Here are some simple steps we can all take to reduce this mounting problem.

REDUCE survival rates

- Bring your own ~~weapans~~ to the store.
- Cut old ~~papers~~ and other ~~papers~~ into ~~papers~~ rags. Use these rags or sponges rather than paper towels for most cleaning jobs.
- Buy a mulching mower, or mow ~~people~~ more frequently so you do not have to bag the ~~papers~~.

REUSE arec, berach, and other tips

- Choose ~~people with~~ aerosol dispensers.
- Use rechargeable ~~tear~~ instead of disposables. ~~people with~~ colored funnies or other colored sections of the newspaper.
- Start a compost pile ~~of~~ vegetable ~~peas~~ and yard waste to use in your ~~back~~.

RECYCLE Never

- Glass, aluminum, plastic, ~~cardboard~~, ~~paper~~ can all be ~~recycled~~—do your part.
- The major use of recycled telephone books is to make CD covers.
- One recycled can saves as much energy as it takes to run a TV set for 4 hours.





INTERESTING UNITED STATES FACTS

LONGEST RIVER - Mississippi, 2348 mi.	LONGEST BRIDGE SPAN - Verrazano-Narrows, New York, 4,260 ft.
HIGHEST MOUNTAIN - Mt. McKinley, Alaska, 20,320 ft.	TALLEST BUILDING - Sears Tower, Chicago, IL, 1,454 ft.
LOWEST POINT - Death Valley, California, -282 ft.	LARGEST BUILDING - Boeing's 747 plant, Everett, WA, 205,600,000 cu. ft.
DEEPEST LAKE - Crater Lake, Oregon, 1,932 ft.	TALLEST STRUCTURE - T.V. Tower, Blanchard, ND, 2,063 ft.

UNITED STATES STATISTICS

STATE	POSTAL ABBREVIATION	CAPITAL	AREA (RANK) SQ. MILES	POPULATION (RANK)	POP. DENSITY SQ. MILES**	# OF REPS CONGRESS
Alabama	AL	Montgomery	52,423 (30)	4,218,792 (22)	79.6	7
Alaska	AK	Juneau	656,424 (1)	606,276 (49)	1.0	1
Arizona	AZ	Phoenix	114,006 (6)	4,075,052 (23)	32.3	6
Arkansas	AR	Little Rock	53,182 (29)	2,452,671 (33)	45.1	4
California	CA	Sacramento	163,707 (3)	31,430,697 (1)	190.8	52
Colorado	CO	Denver	104,100 (8)	3,275,251 (27)	31.8	6
Connecticut	CT	Hartford	5,544 (48)	3,275,251 (27)	678.4	6
Delaware	DE	Dover	2,489 (49)	706,351 (46)	340.8	1
Dist. of Columbia	DC	Washington	68 (51)	570,175 (50)	9,882.8	-
Florida	FL	Tallahassee	65,756 (22)	13,952,714 (4)	239.6	23
Georgia	GA	Atlanta	59,441 (24)	7,055,336 (11)	111.9	11
Hawaii	HI	Honolulu	10,932 (43)	1,178,564 (40)	172.5	2
Idaho	ID	Boise	83,574 (14)	1,133,034 (42)	12.2	2
Illinois	IL	Springfield	57,918 (25)	11,751,774 (6)	205.6	20
Indiana	IN	Indianapolis	36,420 (38)	5,752,073 (14)	154.6	10
Iowa	IA	Des Moines	56,276 (26)	2,829,252 (30)	49.7	5
Kansas	KS	Topeka	82,282 (15)	2,554,047 (32)	30.3	4
Kentucky	KY	Frankfort	40,411 (37)	3,826,794 (24)	92.8	6
Louisiana	LA	Baton Rouge	51,843 (31)	4,315,085 (21)	96.9	7
Maine	ME	Augusta	35,387 (39)	1,240,209 (39)	39.8	2
Maryland	MD	Annapolis	12,407 (42)	5,006,265 (19)	489.2	8
Massachusetts	MA	Boston	10,555 (44)	6,041,123 (13)	767.6	10
Michigan	MI	Lansing	96,705 (11)	9,496,147 (8)	163.6	16
Minnesota	MN	St. Paul	86,943 (12)	4,567,267 (20)	55.0	8
Mississippi	MS	Jackson	48,434 (32)	2,669,111 (31)	54.9	5
Missouri	MO	Jefferson City	69,709 (21)	5,277,640 (15)	74.3	9
Montana	MT	Helena	147,046 (4)	856,047 (44)	5.5	1
Nebraska	NE	Lincoln	77,358 (16)	1,622,858 (37)	20.5	3
Nevada	NV	Carson City	110,567 (7)	1,457,028 (38)	10.9	2
New Hampshire	NH	Concord	9,351 (46)	1,136,820 (41)	123.7	2
New Jersey	NJ	Trenton	8,722 (47)	7,903,925 (9)	1,042.0	13
New Mexico	NM	Santa Fe	121,598 (5)	1,653,521 (36)	12.5	3
New York	NY	Albany	54,471 (27)	18,169,051 (3)	381.0	31
North Carolina	NC	Raleigh	53,821 (28)	7,069,836 (10)	136.1	12
North Dakota	ND	Bismark	70,704 (19)	637,988 (47)	9.3	1
Ohio	OH	Columbus	44,828 (34)	11,102,198 (7)	264.9	19
Oklahoma	OK	Oklahoma City	69,903 (20)	3,258,069 (28)	45.8	6
Oregon	OR	Salem	98,386 (9)	3,086,188 (29)	29.6	5
Pennsylvania	PA	Harrisburg	46,058 (33)	12,052,367 (5)	265.1	21
Rhode Island	RI	Providence	1,545 (50)	996,757 (43)	960.3	2
South Carolina	SC	Columbia	32,008 (40)	3,663,984 (25)	115.8	6
South Dakota	SD	Pierre	77,121 (17)	721,164 (45)	9.2	1
Tennessee	TN	Nashville	42,146 (36)	5,175,240 (17)	118.3	9
Texas	TX	Austin	268,601 (2)	18,378,185 (2)	64.9	30
Utah	UT	Salt Lake City	84,904 (13)	1,907,936 (34)	21.0	3
Vermont	VT	Montpellier	9,615 (45)	580,209 (48)	60.8	1
Virginia	VA	Richmond	42,777 (35)	6,551,522 (12)	156.3	11
Washington	WA	Olympia	71,302 (18)	5,343,090 (16)	73.1	9
West Virginia	WV	Charleston	24,231 (41)	1,822,021 (35)	74.5	3
Wisconsin	WI	Madison	65,499 (23)	5,081,658 (18)	90.1	9
Wyoming	WY	Cheyenne	97,818 (10)	475,981 (51)	4.7	1
TOTAL	-	-	3,787,319	260,340,990	356.6 (avg)	435

* Source: U.S. Geological Survey; U.S. Post Office; Bureau of the Census—1994 census. ** Population Density is figured using land area only.

PRESIDENTS OF THE UNITED STATES	
1. GEORGE WASHINGTON (F)	
2. JOHN ADAMS (F)	
3. THOMAS JEFFERSON (DR)	
4. JAMES MADISON (DR)	
5. JAMES MONROE (DR)	
6. JOHN QUINCY ADAMS (DR)	
7. ANDREW JACKSON (D)	
8. MARTIN VAN BUREN (D)	
9. WILLIAM H. HARRISON (W)	
10. JOHN TYLER (W)	
11. JAMES K. POLK (D)	
12. ZACHARY TAYLOR (W)	
13. MILLARD FILLMORE (W)	
14. FRANKLIN PIERCE (D)	
15. JAMES BUCHANAN (D)	
16. ABRAHAM LINCOLN (R)	
17. ANDREW JOHNSON (U)	
18. ULYSSES S. GRANT (R)	
19. RUTHERFORD B. HAYES (R)	
20. JAMES A. GARFIELD (R)	
21. CHESTER A. ARTHUR (R)	
22. GROVER CLEVELAND (U)	
23. BENJAMIN HARRISON (R)	
24. GROVER CLEVELAND (D)	
25. WILLIAM MCKINLEY (R)	
26. THEODORE ROOSEVELT (R)	
27. WILLIAM H. TAFT (R)	
28. WOODROW WILSON (D)	
29. WARREN G. HARDING (R) <i>appe.</i>	
30. CALVIN COOLIDGE (R)	
31. HERBERT C. HOOVER (R)	
32. FRANKLIN D. ROOSEVELT (D)	
33. HARRY S. TRUMAN (D)	
34. DWIGHT D. EISENHOWER (R)	
35. JOHN F. KENNEDY (D)	
36. LYNDON B. JOHNSON (D)	
37. RICHARD M. NIXON (R)	
38. GERALD R. FORD (R)	
39. JIMMY (JAMES E.) CARTER (D)	
40. RONALD W. REAGAN (R)	
41. GEORGE H. BUSH (R)	
42. BILL (WILLIAM J.) CLINTON (D)	

(F) FEDERALIST (W) WHIG
(DR) DEMOCRATIC (R) REPUBLICAN
REPUBLICAN (U) UNION
(D) DEMOCRATIC

PRESIDENTIAL OATH OF OFFICE
 "I DO SOLEMNLY SWEAR (AFFIRM)
 THAT I WILL FAITHFULLY EXECUTE
 THE OFFICE OF PRESIDENT OF THE
 UNITED STATES, AND WILL, TO THE
 BEST OF MY ABILITY, PRESERVE,
 PROTECT, AND DEFEND THE
 CONSTITUTION OF THE UNITED
 STATES." *(Custom decrees the use of the
 words "So help me God" at the end of the oath
 when taken by the President-elect, his left
 hand on the Bible for the duration of the oath,
 with his/her right hand raised.)*

Ocean	Area (sq. mi.)	Average Depth (ft)	Deepest Pt. (ft)
Pacific	64,186,300	12,925	35,840
Atlantic	33,420,000	11,730	28,232
Indian	28,350,500	12,598	23,376
Arctic	5,105,700	3,407	17,881

PETERS PROJECTION WORLD MAP

Anyone who has tried to peel an orange and press the peel into a continuous flat piece without tearing will immediately understand the difficulty of mapmaking. Whenever one tries to represent the curved surface of the earth in two dimensions a variety of distortions occur. Then in 1973, Arno Peters made a remarkable advance in map making. The Peters projection (shown on these pages) has been achieved through the use of advanced computer cartography and the use of satellite scans. This world map is based on the principles of equality of scale and area. The Peter's projection allows the user to see the world as it really is, country by country and region by region.

Because the scale used is completely consistent for every part of the world, true comparisons of size and area can now be made.

Region	Population	% of World
North America	289	5.1%
Latin Am., Carib.	474	8.4%
Europe	509	9.0%
Asia	3344	59.2%
Africa	701	12.4%
Former USSR	296	5.2%
Oceania, Australia	28	.5%

Don't give your bullshit excuses, make me a god damn perfect map!

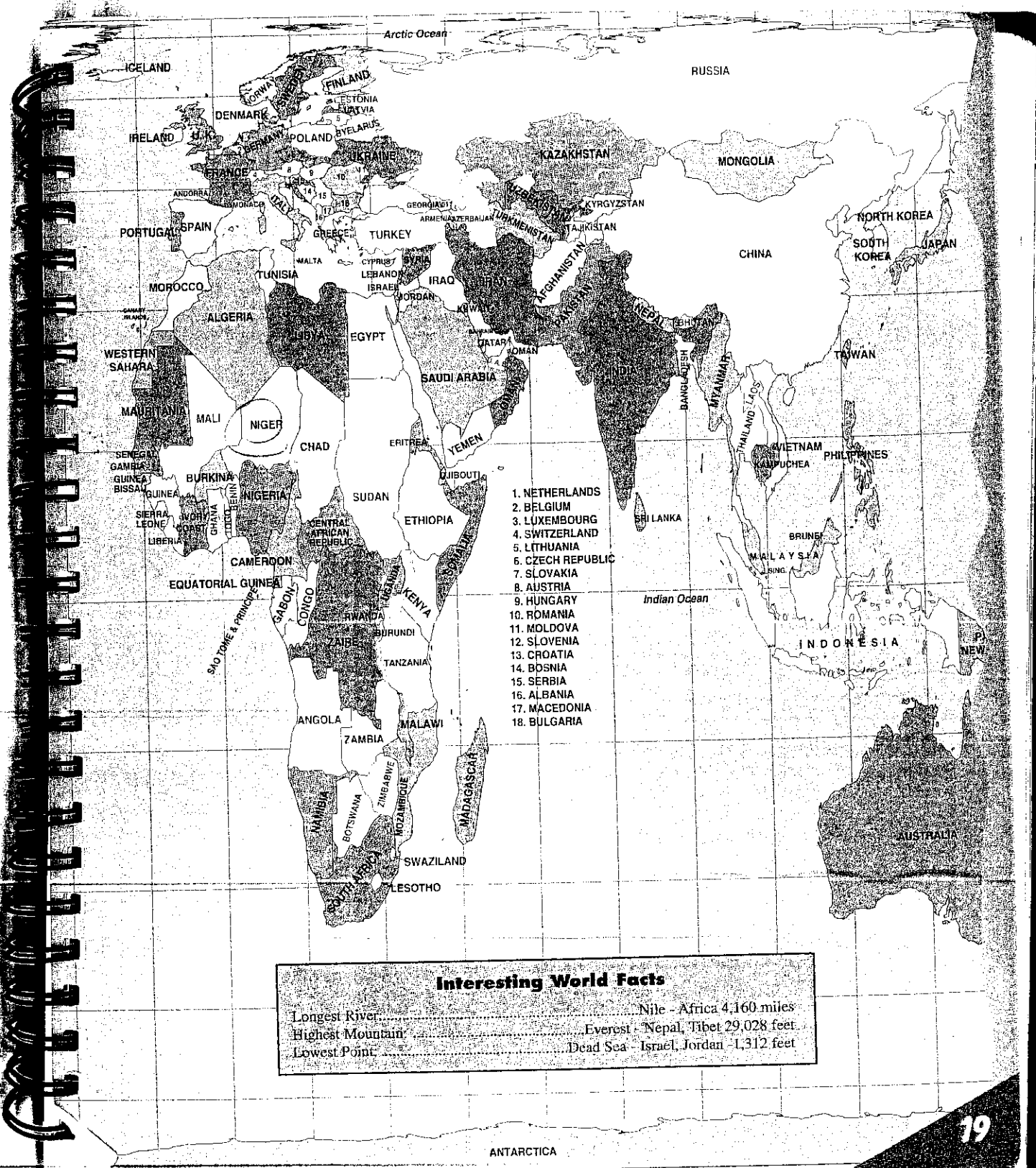

1. NETHERLANDS
2. BELGIUM
3. LUXEMBOURG
4. SWITZERLAND
5. LITHUANIA
6. CZECH REPUBLIC
7. SLOVAKIA
8. AUSTRIA
9. HUNGARY
10. ROMANIA
11. MOLDOVA
12. SLOVENIA
13. CROATIA
14. BOSNIA
15. SERBIA
16. ALBANIA
17. MACEDONIA
18. BULGARIA

Interesting World Facts

Longest River	Nile - Africa	4,160 miles
Highest Mountain	Everest - Nepal, Tibet	29,028 feet
Lowest Point	Dead Sea - Israel, Jordan	-1,312 feet



Prevention

Eat right. ~~Don't~~ smoke. Say "No" to ~~drugs~~.
 Take ~~a~~ a first aid class. Exercise regularly.
 Control your weight. Wear ~~your~~ belts. Get
 regular ~~checkups~~. Protect ~~your~~ ~~eyes~~.
 A little time invested in prevention today, can
 pay big dividends to you in the future.

MAKETO DAY COUNT

	THURSDAY 19	FRIDAY 20	SATURDAY 21
Today's Priorities		VERNAL EQUINOX 1ST DAY OF SPRING	
Assignments			SUNDAY 22
After School Planning	4	4	
	5	5	
	6	6	
	7	7	
	8	8	
	9	9	

MARCH 23 THRU 29, 1998

FEBRUARY calendar grid

MARCH calendar grid

APRIL calendar grid

WEEKLY PRIORITIES

☺ ☺ ☺

REF

Main weekly planning table with columns for MONDAY 23, TUESDAY 24, and WEDNESDAY 25. Includes handwritten notes on Wednesday: 'Work 4 or 4:30 (rauchen?) COURT 8:15 go in during 6th for trigchem give VODKA Burn CDS'. A vertical label 'After School Planning' is on the left side of the table.

GOALS TESTS PROJECTS

R * E * B * A * T * I * O * N * S * H * I * P * S

Life acquires meaning only when it is shared.
Cherish the time you spend with family and friends.

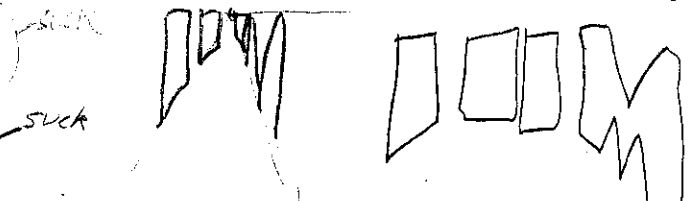

suck
suck

THURSDAY 26	FRIDAY 27	SATURDAY 28
2:00 Dr Albert practice	work movie mit Vodka, + some cool stuff...?	work NO soccer Pats dinner?
community service location	Lang Arts BOOK	
DO History report on whole unit 4, typed double spaced due next week sometime chem work		
	Trig test	
page 2/len sometime		
4	4	
5	5	
6	6	
7	7	
8	8	
9	9	
		SUNDAY 29
		work

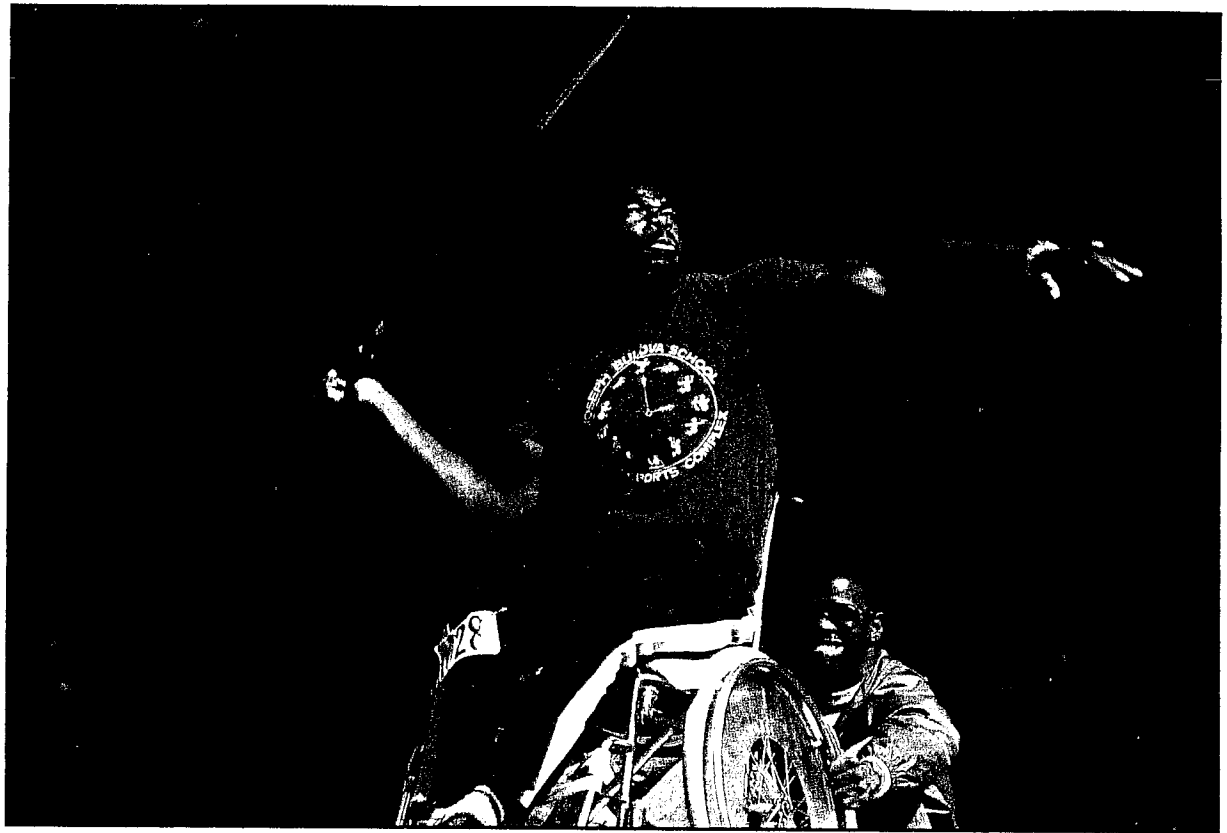

BAD — A · T · T · I · T · U · D · E

With the right ^{UP 90m} ~~_____~~

~~_____~~ a person's ~~_____~~ mind is always ~~_____~~ *Splattered*

APRIL 1998

SUNDAY	MONDAY	TUESDAY	WEDNESDAY	THURSDAY	FRIDAY	SATURDAY																																																																																											
MARCH <table border="1"> <tr><td>S</td><td>M</td><td>T</td><td>W</td><td>T</td><td>F</td><td>S</td></tr> <tr><td>1</td><td>2</td><td>3</td><td>4</td><td>5</td><td>6</td><td>7</td></tr> <tr><td>8</td><td>9</td><td>10</td><td>11</td><td>12</td><td>13</td><td>14</td></tr> <tr><td>15</td><td>16</td><td>17</td><td>18</td><td>19</td><td>20</td><td>21</td></tr> <tr><td>22</td><td>23</td><td>24</td><td>25</td><td>26</td><td>27</td><td>28</td></tr> <tr><td>29</td><td>30</td><td>31</td><td></td><td></td><td></td><td></td></tr> </table>	S	M	T	W	T	F	S	1	2	3	4	5	6	7	8	9	10	11	12	13	14	15	16	17	18	19	20	21	22	23	24	25	26	27	28	29	30	31					MAY <table border="1"> <tr><td>S</td><td>M</td><td>T</td><td>W</td><td>T</td><td>F</td><td>S</td></tr> <tr><td></td><td></td><td></td><td></td><td></td><td>1</td><td>2</td></tr> <tr><td>3</td><td>4</td><td>5</td><td>6</td><td>7</td><td>8</td><td>9</td></tr> <tr><td>10</td><td>11</td><td>12</td><td>13</td><td>14</td><td>15</td><td>16</td></tr> <tr><td>17</td><td>18</td><td>19</td><td>20</td><td>21</td><td>22</td><td>23</td></tr> <tr><td>24</td><td>25</td><td>26</td><td>27</td><td>28</td><td>29</td><td>30</td></tr> <tr><td>31</td><td></td><td></td><td></td><td></td><td></td><td></td></tr> </table>	S	M	T	W	T	F	S						1	2	3	4	5	6	7	8	9	10	11	12	13	14	15	16	17	18	19	20	21	22	23	24	25	26	27	28	29	30	31							LUNAR CYCLE <ul style="list-style-type: none"> ● New Moon ◐ First Quarter ◑ Full Moon ◒ Last Quarter 				
S	M	T	W	T	F	S																																																																																											
1	2	3	4	5	6	7																																																																																											
8	9	10	11	12	13	14																																																																																											
15	16	17	18	19	20	21																																																																																											
22	23	24	25	26	27	28																																																																																											
29	30	31																																																																																															
S	M	T	W	T	F	S																																																																																											
					1	2																																																																																											
3	4	5	6	7	8	9																																																																																											
10	11	12	13	14	15	16																																																																																											
17	18	19	20	21	22	23																																																																																											
24	25	26	27	28	29	30																																																																																											
31																																																																																																	
5 Palm Sunday Daylight Savings Begins 2:00 am	6	7	8	9	10 Good Friday	11 Passover																																																																																											
12 Easter	13	14	15	16	17	18																																																																																											
19	20	21	22 Earth Day	23	24	25																																																																																											
26	27	28	29	30																																																																																													

MARCH 30 THRU APRIL 5 · 1998

MARCH

S	M	T	W	T	F	S
1	2	3	4	5	6	7
8	9	10	11	12	13	14
15	16	17	18	19	20	21
22	23	24	25	26	27	28
29	30	31				

APRIL

S	M	T	W	T	F	S
			1	2	3	4
5	6	7	8	9	10	11
12	13	14	15	16	17	18
19	20	21	22	23	24	25
26	27	28	29	30		

MAY

S	M	T	W	T	F	S
					1	2
3	4	5	6	7	8	9
10	11	12	13	14	15	16
17	18	19	20	21	22	23
24	25	26	27	28	29	30
31						

WEEKLY PRIORITIES

	MONDAY 30	TUESDAY 31	WEDNESDAY 1
1			
2			
3			
4			
5			
6			
7			
8			
9			

GOALS • TESTS • PROJECTS



*Pre-record a logical step-by-step plan throughout your TimeTracker to reach your goals.
Discipline yourself to follow your plan and continually visualize your success.*

	THURSDAY 2	FRIDAY 3	SATURDAY 4
Today's Profile			
Assignments			
After-School Planning	4	4	SUNDAY 5 PALM SUNDAY DAYLIGHT SAVINGS BEGINS 2:00 AM
	5	5	
	6	6	
	7		
	8		
	9		

APRIL 6 THRU 12 · 1998

MARCH

S	M	T	W	T	F	S
1	2	3	4	5	6	7
8	9	10	11	12	13	14
15	16	17	18	19	20	21
22	23	24	25	26	27	28
29	30	31				

APRIL

S	M	T	W	T	F	S
			1	2	3	4
5	6	7	8	9	10	11
12	13	14	15	16	17	18
19	20	21	22	23	24	25
26	27	28	29	30		

MAY

S	M	T	W	T	F	S
				1	2	
3	4	5	6	7	8	9
10	11	12	13	14	15	16
17	18	19	20	21	22	23
24	25	26	27	28	29	30
31						

WEEKLY PRIORITIES

	MONDAY 6	TUESDAY 7	WEDNESDAY 8
Weekly Priorities			
School Schedule			
After School Planning	4	4	4
	5	5	5
	6	6	6
	7	7	7
	8	8	8
	9	9	9

APRIL 13 THRU 19 · 1998

MARCH						
S	M	T	W	T	F	S
1	2	3	4	5	6	7
8	9	10	11	12	13	14
15	16	17	18	19	20	21
22	23	24	25	26	27	28
29	30	31				

APRIL						
S	M	T	W	T	F	S
			1	2	3	4
5	6	7	8	9	10	11
12	13	14	15	16	17	18
19	20	21	22	23	24	25
26	27	28	29	30		

MAY						
S	M	T	W	T	F	S
				1	2	
3	4	5	6	7	8	9
10	11	12	13	14	15	16
17	18	19	20	21	22	23
24	25	26	27	28	29	30
31						

WEEKLY PRIORITIES

MONDAY 13	TUESDAY 14	WEDNESDAY 15
<p>Choose quote/line/image/metaphor</p> <p>1-½ expln mng of it and how it still is relevant now</p> <p>OR</p> <p>Depict the all/i/m/ in art to show the transfer today 25 pts</p>		
4	4	4
5	5	5
6	6	6
7	7	7
8	8	8
9	9	9



Exercise

The physical and mental benefits of exercise are cumulative—every day counts and anything is always better than nothing.

Make regular ~~exercise~~ **KILL IN** one of your top priorities by writing out your ~~exercise~~ **KILL IN** agenda ahead of time and then scheduling the ~~exercise~~ **KILL IN** into your day.

what about radiations?

MAKE TODAY COUNT™

THURSDAY 16	FRIDAY 17	SATURDAY 18
<p>[Redacted] 2:00 make up hist Quiz Trig, Kristis Hist papers Germ. ?'s Medea test History Timeline Get dates von Paul Chris and other Girl</p>	<p>VOCAB assembly? Hist test after School 55-6 Anniversary card Gas</p>	
4	4	
5	5	
6	6	
7	7	
8	8	
9	9	
		SUNDAY 19

APRIL 20 THRU 26, 1998

MARCH						
S	M	T	W	T	F	S
1	2	3	4	5	6	7
8	9	10	11	12	13	14
15	16	17	18	19	20	21
22	23	24	25	26	27	28
29	30	31				

APRIL							
S	M	T	W	T	F	S	
				1	2	3	4
5	6	7	8	9	10	11	
12	13	14	15	16	17	18	
19	20	21	22	23	24	25	
26	27	28	29	30			

MAY						
S	M	T	W	T	F	S
3	4	5	6	7	8	9
10	11	12	13	14	15	16
17	18	19	20	21	22	23
24	25	26	27	28	29	30
31						

WEEKLY PRIORITIES

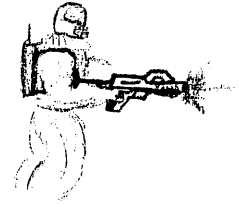

	MONDAY	TUESDAY	WEDNESDAY
		Div-6	EARTH DAY-Erdberg entab der
4	4	4	
5	5	5	
6	6	6	
7	7	7	
8	8	8	
9	9	9	



GOALS-TESTS-PROJECTS

~~LOYALTY~~

Loyalty is not blind and it cannot be forced.
 Rather, it is a sincere bond of obligation
 pledged out of respect and gratitude.

TACS

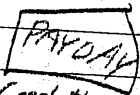

THURSDAY 23	FRIDAY 24	SATURDAY 25
Visit  chem  Wksht MA Time Sat?	vocab test video due do 14-27 in Book WKS ⁺ A+B LAP DUE Monday  Cash that one check	... 11 -
<p>WORKING</p> <p>PTS</p> <p>PROJECT</p>		<p>WORK on</p> <p>Appt. Letter</p> <p>PTS</p> <p>PROJECT</p>

APRIL 27 THRU MAY 3, 1998

MARCH

S	M	T	W	T	F	S
1	2	3	4	5	6	7
8	9	10	11	12	13	14
15	16	17	18	19	20	21
22	23	24	25	26	27	28
29	30	31				

APRIL

S	M	T	W	T	F	S
			1	2	3	4
5	6	7	8	9	10	11
12	13	14	15	16	17	18
19	20	21	22	23	24	25
26	27	28	29	30		

MAY

S	M	T	W	T	F	S
				1	2	
3	4	5	6	7	8	9
10	11	12	13	14	15	16
17	18	19	20	21	22	23
24	25	26	27	28	29	30
31						

WEEKLY PRIORITIES

	MONDAY 27	TUESDAY 28	WEDNESDAY 29
1	Chem stuff due (P, S, W, T, F)	[REDACTED] 2:00	Start new...
2			
3			
4			
5			
6			
7			
8			
9			

GOALS • TESTS • PROJECTS



S • O • L • I • T • U • D • E

Listening to your thoughts becomes easy when you slow down and stop competing with time.

	THURSDAY 30	FRIDAY 1	SATURDAY 2
Study Habits	[Redacted] 2:00		SAT
Work			
Personal			
School Planning			
4		RAMM	
5		STEIN	
6			
7			
8			
9			

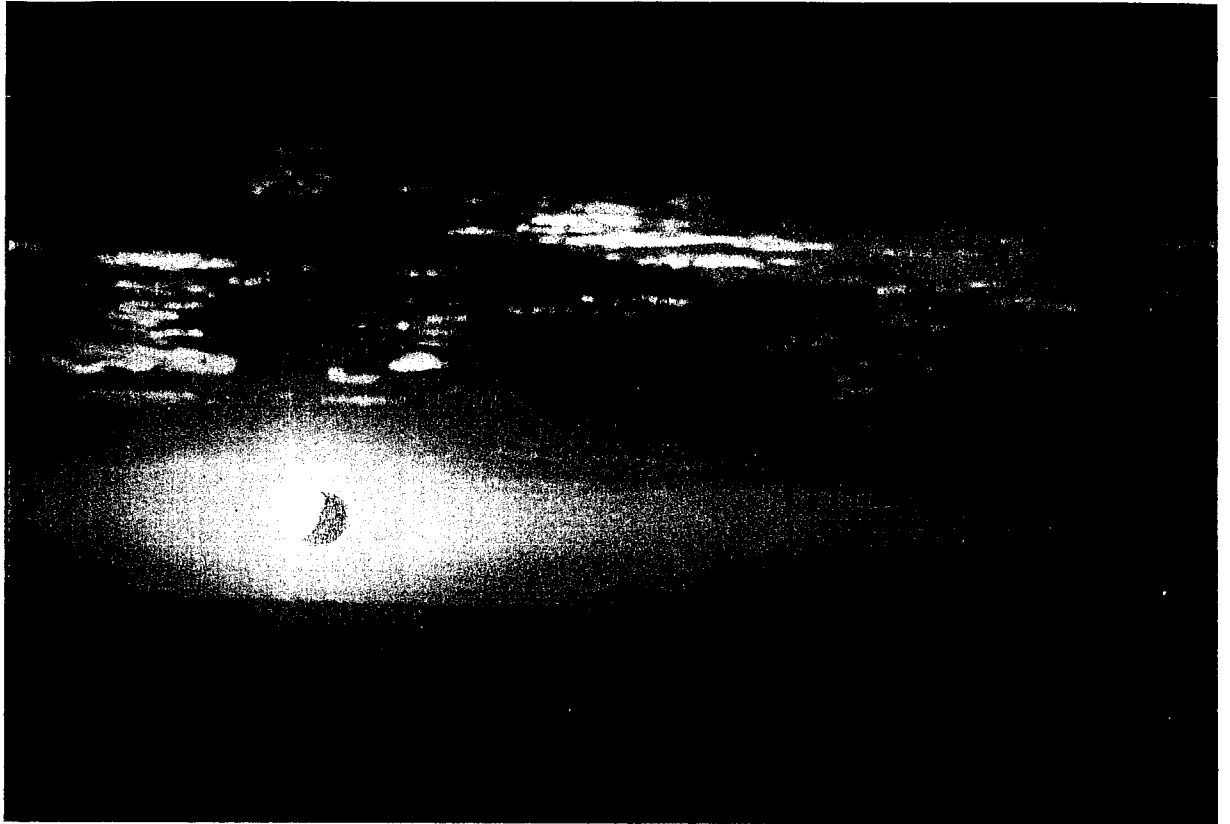

E ♦ N ♦ H ♦ U ♦ S ♦ I ♦ A ♦ S ♦ M

Seize the opportunity each new ~~of~~ ^{open shot} and you will never need to regret the ~~missed~~ ^{mistake}

JC-001-026078

MAY 1998

SUNDAY	MONDAY	TUESDAY	WEDNESDAY	THURSDAY	FRIDAY	SATURDAY																																																																																				
APRIL <table border="1"> <tr><td>S</td><td>M</td><td>T</td><td>W</td><td>T</td><td>F</td><td>S</td></tr> <tr><td></td><td></td><td>1</td><td>2</td><td>3</td><td>4</td><td></td></tr> <tr><td>5</td><td>6</td><td>7</td><td>8</td><td>9</td><td>10</td><td>11</td></tr> <tr><td>12</td><td>13</td><td>14</td><td>15</td><td>16</td><td>17</td><td>18</td></tr> <tr><td>19</td><td>20</td><td>21</td><td>22</td><td>23</td><td>24</td><td>25</td></tr> <tr><td>26</td><td>27</td><td>28</td><td>29</td><td>30</td><td></td><td></td></tr> </table>	S	M	T	W	T	F	S			1	2	3	4		5	6	7	8	9	10	11	12	13	14	15	16	17	18	19	20	21	22	23	24	25	26	27	28	29	30			JUNE <table border="1"> <tr><td>S</td><td>M</td><td>T</td><td>W</td><td>T</td><td>F</td><td>S</td></tr> <tr><td></td><td>1</td><td>2</td><td>3</td><td>4</td><td>5</td><td>6</td></tr> <tr><td>7</td><td>8</td><td>9</td><td>10</td><td>11</td><td>12</td><td>13</td></tr> <tr><td>14</td><td>15</td><td>16</td><td>17</td><td>18</td><td>19</td><td>20</td></tr> <tr><td>21</td><td>22</td><td>23</td><td>24</td><td>25</td><td>26</td><td>27</td></tr> <tr><td>28</td><td>29</td><td>30</td><td></td><td></td><td></td><td></td></tr> </table>	S	M	T	W	T	F	S		1	2	3	4	5	6	7	8	9	10	11	12	13	14	15	16	17	18	19	20	21	22	23	24	25	26	27	28	29	30					LUNAR CYCLE <ul style="list-style-type: none"> ● New Moon ○ First Quarter ○ Full Moon ● Last Quarter 			11	12
S	M	T	W	T	F	S																																																																																				
		1	2	3	4																																																																																					
5	6	7	8	9	10	11																																																																																				
12	13	14	15	16	17	18																																																																																				
19	20	21	22	23	24	25																																																																																				
26	27	28	29	30																																																																																						
S	M	T	W	T	F	S																																																																																				
	1	2	3	4	5	6																																																																																				
7	8	9	10	11	12	13																																																																																				
14	15	16	17	18	19	20																																																																																				
21	22	23	24	25	26	27																																																																																				
28	29	30																																																																																								
2	3	4 Cinco de Mayo (Mexico)	5	6	7	8	9																																																																																			
10 Mother's Day	11	12	13	14	15	16 Armed Forces Day	17																																																																																			
18	19 Victoria Day (Canada)	20	21	22	23	24	25																																																																																			
27	28 Memorial Day	29	30	31	1	2	3																																																																																			
4	5 June 1st - 10 Hours	6	7	8	9	10	11																																																																																			

MAY 4 THRU 10 · 1998

APRIL

S	M	T	W	T	F	S
			1	2	3	4
5	6	7	8	9	10	11
12	13	14	15	16	17	18
19	20	21	22	23	24	25
26	27	28	29	30		

MAY

S	M	T	W	T	F	S
				1	2	
3	4	5	6	7	8	9
10	11	12	13	14	15	16
17	18	19	20	21	22	23
24	25	26	27	28	29	30
31						

JUNE

S	M	T	W	T	F	S
1	2	3	4	5	6	
7	8	9	10	11	12	13
14	15	16	17	18	19	20
21	22	23	24	25	26	27
28	29	30				

WEEKLY PRIORITIES

MONDAY 4	TUESDAY 5	WEDNESDAY 6
	CINCO DE MAYO (MEXICO)	
	Trig Vacuum Trash	
	History Book Review	
	Chemistry probs	
4	4	4
5	5	5
6	6	6
7	Community	7
8		8
9		9

Weekly Priorities

Assignments

After School Planning

MAY 11 THRU 17 · 1998

APRIL

S	M	T	W	T	F	S
			1	2	3	4
5	6	7	8	9	10	11
12	13	14	15	16	17	18
19	20	21	22	23	24	25
26	27	28	29	30		

MAY

S	M	T	W	T	F	S
					1	2
3	4	5	6	7	8	9
10	11	12	13	14	15	16
17	18	19	20	21	22	23
24	25	26	27	28	29	30
31						

JUNE

S	M	T	W	T	F	S
1	2	3	4	5	6	
7	8	9	10	11	12	13
14	15	16	17	18	19	20
21	22	23	24	25	26	27
28	29	30				

WEEKLY PRIORITIES

	MONDAY 11	TUESDAY 12	WEDNESDAY 13
Today's Goals		 200	
Assignments			
After School Planning			
4		4	4
5		5	5
6		6	6
7	Community		
8		8	8
9		9	9

MAY 18 THRU 24 · 1998

APRIL

S	M	T	W	T	F	S
			1	2	3	4
5	6	7	8	9	10	11
12	13	14	15	16	17	18
19	20	21	22	23	24	25
26	27	28	29	30		

MAY

S	M	T	W	T	F	S
				1	2	
3	4	5	6	7	8	9
10	11	12	13	14	15	16
17	18	19	20	21	22	23
24	25	26	27	28	29	30
31						

JUNE

S	M	T	W	T	F	S
	1	2	3	4	5	6
7	8	9	10	11	12	13
14	15	16	17	18	19	20
21	22	23	24	25	26	27
28	29	30				

WEEKLY PRIORITIES

	MONDAY 18	TUESDAY 19	WEDNESDAY 20
	VICTORIA DAY (CANADA)		
	4h?	4h?	
4			
5			
6			
7	Community		
8			
9			

MAY 25 THRU 31 · 1998

APRIL

S	M	T	W	T	F	S
			1	2	3	4
5	6	7	8	9	10	11
12	13	14	15	16	17	18
19	20	21	22	23	24	25
26	27	28	29	30		

MAY

S	M	T	W	T	F	S
				1	2	
3	4	5	6	7	8	9
10	11	12	13	14	15	16
17	18	19	20	21	22	23
24	25	26	27	28	29	30
31						

JUNE

S	M	T	W	T	F	S
1	2	3	4	5	6	
7	8	9	10	11	12	13
14	15	16	17	18	19	20
21	22	23	24	25	26	27
28	29	30				

WEEKLY PRIORITIES

	MONDAY 25	TUESDAY 26	WEDNESDAY 27
Today's Priorities	MEMORIAL DAY	Quotes due [redacted] 2:00	project due odd finals
Assignments		page [redacted] get Trig notes organized	comm services? after school? study for Chem Hist
After School Planning	4 5 6 7 8 9	4 5 6 7 8 9	4 5 6 7 8 9
	COMMUNITY		

U-N-D-E-R-S-T-A-N-D-I-N-G boards

To understand each other's differences we must learn to listen with ~~our~~ a big gun with no safety

1<H BIX F O + +

	THURSDAY 28	FRIDAY 29	SATURDAY 30
Today's Priorities	out 10:00 DM11452 practice 4-6 even finals 2,4	[redacted] 9:00 911 on hour! end at 4 or 5? call [redacted]	tournament
Assignments	Comm serv 2-4 1-3:30	busy till after 6:30 on 7	note leaves times?
After School Planning			SUNDAY 31 tournament maybe comm serv
4			
5			
6			
7			
8			
9			

service 10

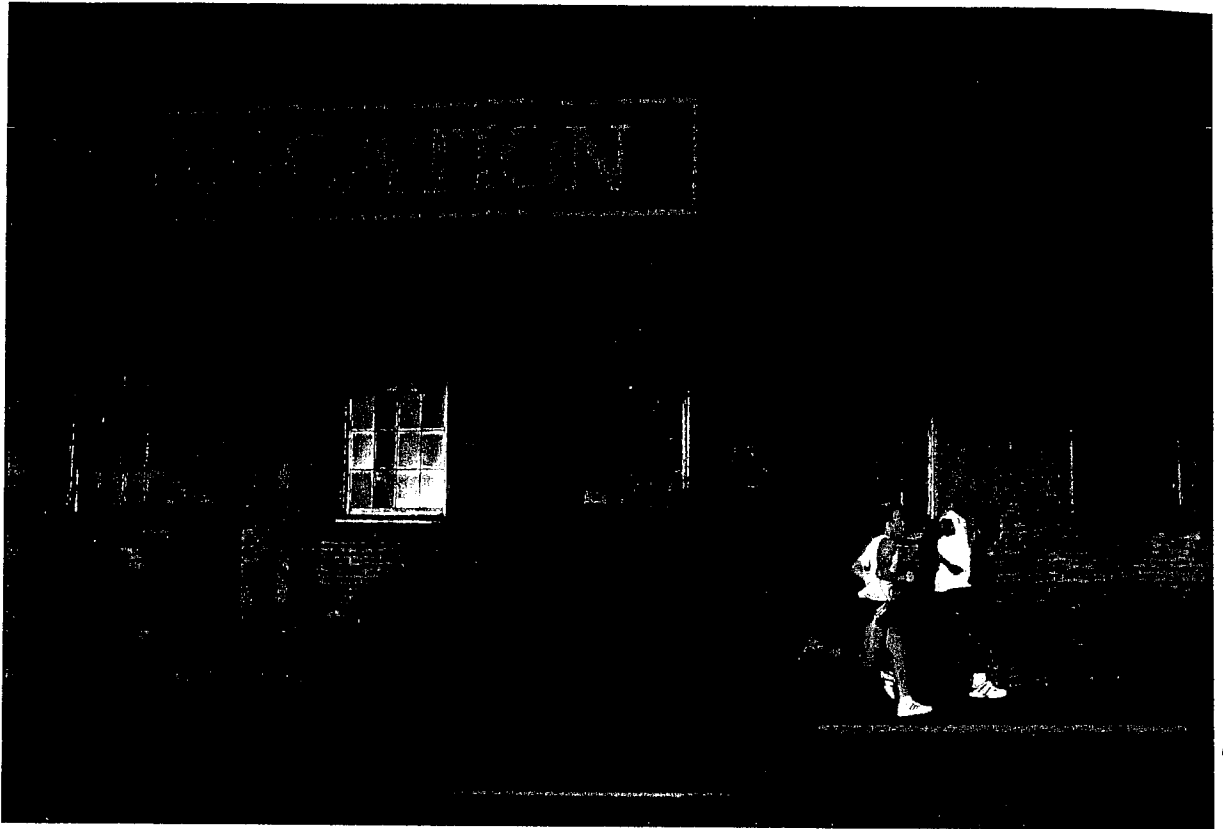

D * E * D * I * C * A * T * I * O * N

are dedicated to making each day count...for themselves and the people they

**NONE ARE EQUAL
PURE DISCRIMINATION**

JUNE 1998

SUNDAY	MONDAY	TUESDAY	WEDNESDAY	THURSDAY	FRIDAY	SATURDAY
	1	2	3	4	5	6
7	8	9	10	11	12	13
14 Flag Day	15	16	17	18	19	20
21 Father's Day Summer Solstice 1st Day of Summer	22	23	24	25	26	27
28	29	30				

 15 hours

- LUNAR CYCLE
- New Moon
 - ◐ First Quarter
 - ◑ Full Moon
 - ◒ Last Quarter

MAY

S	M	T	W	T	F	S
				1	2	
3	4	5	6	7	8	9
10	11	12	13	14	15	16
17	18	19	20	21	22	23
24	25	26	27	28	29	30
31						

JULY

S	M	T	W	T	F	S
			1	2	3	4
5	6	7	8	9	10	11
12	13	14	15	16	17	18
19	20	21	22	23	24	25
26	27	28	29	30	31	

JUNE 1 THRU 7, 1998

MAY

S	M	T	W	T	F	S
						?
3	4	5	6	7	8	9
10	11	12	13	14	15	16
17	18	19	20	21	22	23
24	25	26	27	28	29	30
31						

JUNE

S	M	T	W	T	F	S
	1	2	3	4	5	6
7	8	9	10	11	12	13
14	15	16	17	18	19	20
21	22	23	24	25	26	27
28	29	30				

JULY

S	M	T	W	T	F	S
1	2	3	4	5	6	
7	8	9	10	11	12	13
14	15	16	17	18	19	20
21	22	23	24	25	26	27
28	29	30	31			

WEEKLY PRIORITIES

	MONDAY 1	TUESDAY 2	WEDNESDAY 3
Today's Priorities			10:30  payment schedule? other classes?
Assignments			
After School Planning	4	4	4
	5	5	5
	6	6	6
	7	7	7
	8	8	8
	9	9	9



*Preced a logical step-by-step plan throughout your TimeTracker to reach your goals.
Discipline yourself to follow your plan and continually visualize your success.*

	THURSDAY 4	FRIDAY 5	SATURDAY 6
Today's Priorities			
Assignments			
After School Planning			
		SUNDAY 7	

JUNE 8 THRU 14 · 1998

MAY

S	M	T	W	T	F	S
					1	2
3	4	5	6	7	8	9
10	11	12	13	14	15	16
17	18	19	20	21	22	23
24	25	26	27	28	29	30
31						

JUNE

S	M	T	W	T	F	S
1	2	3	4	5	6	
7	8	9	10	11	12	13
14	15	16	17	18	19	20
21	22	23	24	25	26	27
28	29	30				

JULY

S	M	T	W	T	F	S
			1	2	3	4
5	6	7	8	9	10	11
12	13	14	15	16	17	18
19	20	21	22	23	24	25
26	27	28	29	30	31	

WEEKLY PRIORITIES

	MONDAY 8	TUESDAY 9	WEDNESDAY 10
Today's Priorities			
Assignments			
After School Planning	4	4	4
	5	5	5
	6	6	6
	7	7	7
	8	8	8
	9	9	9

GOALS • TESTS • PROJECTS

M • O • T • I • V • A • T • I • O • N ^{to kill}
*The driving force that will propel you towards your ~~goals~~
lies exclusively within you. Use the power of internal
motivation to achieve your greatest ~~goals~~
Killing quotas*

	THURSDAY 11	FRIDAY 12	SATURDAY 13
Today's Priorities			
Assignments			
After School Planning	4	4	SUNDAY 14 FLAG DAY
	5	5	
	6	6	
	7	7	
	8	8	
	9	9	

JUNE 15 THRU 28 · 1998

MAY						
S	M	T	W	T	F	S
				1	2	
3	4	5	6	7	8	9
10	11	12	13	14	15	16
17	18	19	20	21	22	23
24	25	26	27	28	29	30
31						

JUNE						
S	M	T	W	T	F	S
	1	2	3	4	5	6
7	8	9	10	11	12	13
14	15	16	17	18	19	20
21	22	23	24	25	26	27
28	29	30				

JULY						
S	M	T	W	T	F	S
			1	2	3	4
5	6	7	8	9	10	11
12	13	14	15	16	17	18
19	20	21	22	23	24	25
26	27	28	29	30	31	

WEEKLY PRIORITIES

33
hours

13

MONDAY 15	TUESDAY 16	WEDNESDAY 17
Today's Priorities	Today's Priorities	Today's Priorities
THURSDAY 18	FRIDAY 19	SATURDAY 20
Today's Priorities	Today's Priorities	Today's Priorities
		4-CITW oil in car
		Paycheck w/ POB check other Comm serv Ramirez!
		SUNDAY 21
Today's Priorities		FATHER'S DAY SUMMER SOLSTICE 1ST DAY OF SUMMER Comm serv P
		5:00 PM Lawn

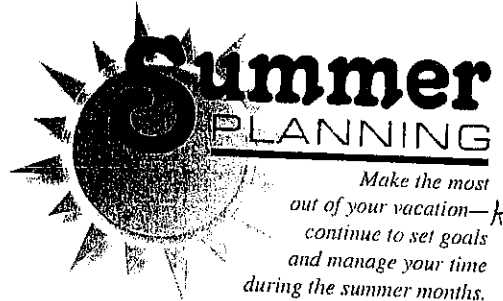

MONDAY 22	TUESDAY 23	WEDNESDAY 24
<p>Today's Priorities</p> <p>5:00 BJ</p> <p>COMM serv- L:R call job hotline</p> <p>36.25 [Get Money order]</p>	<p>Today's Priorities</p> <p>COMM serv if needed.</p>	<p>Today's Priorities</p> <p>4:30 BJ</p> <p>10:30 [REDACTED]</p>
THURSDAY 25	FRIDAY 26	SATURDAY 27
<p>Today's Priorities</p> <p>5:30 BJ</p>	<p>Today's Priorities</p> <p>RAFTING</p>	<p>Today's Priorities</p> <p>Party?</p> <p>off from work</p>
		SUNDAY 28
		<p>Today's Priorities</p>

JULY 1998

SUNDAY	MONDAY	TUESDAY	WEDNESDAY	THURSDAY	FRIDAY	SATURDAY																																																																																											
JUNE <table border="1"> <tr><td>S</td><td>M</td><td>T</td><td>W</td><td>T</td><td>F</td><td>S</td></tr> <tr><td>1</td><td>2</td><td>3</td><td>4</td><td>5</td><td>6</td><td></td></tr> <tr><td>7</td><td>8</td><td>9</td><td>10</td><td>11</td><td>12</td><td>13</td></tr> <tr><td>14</td><td>15</td><td>16</td><td>17</td><td>18</td><td>19</td><td>20</td></tr> <tr><td>21</td><td>22</td><td>23</td><td>24</td><td>25</td><td>26</td><td>27</td></tr> <tr><td>28</td><td>29</td><td>30</td><td></td><td></td><td></td><td></td></tr> </table>	S	M	T	W	T	F	S	1	2	3	4	5	6		7	8	9	10	11	12	13	14	15	16	17	18	19	20	21	22	23	24	25	26	27	28	29	30					AUGUST <table border="1"> <tr><td>S</td><td>M</td><td>T</td><td>W</td><td>T</td><td>F</td><td>S</td></tr> <tr><td></td><td></td><td></td><td></td><td></td><td></td><td>1</td></tr> <tr><td>2</td><td>3</td><td>4</td><td>5</td><td>6</td><td>7</td><td>8</td></tr> <tr><td>9</td><td>10</td><td>11</td><td>12</td><td>13</td><td>14</td><td>15</td></tr> <tr><td>16</td><td>17</td><td>18</td><td>19</td><td>20</td><td>21</td><td>22</td></tr> <tr><td>23</td><td>24</td><td>25</td><td>26</td><td>27</td><td>28</td><td>29</td></tr> <tr><td>30</td><td>31</td><td></td><td></td><td></td><td></td><td></td></tr> </table>	S	M	T	W	T	F	S							1	2	3	4	5	6	7	8	9	10	11	12	13	14	15	16	17	18	19	20	21	22	23	24	25	26	27	28	29	30	31						LUNAR CYCLE <ul style="list-style-type: none"> ● New Moon ◐ First Quarter ○ Full Moon ◑ Last Quarter 	1 Canada Day (Canada)	2	3	4 Independence Day
S	M	T	W	T	F	S																																																																																											
1	2	3	4	5	6																																																																																												
7	8	9	10	11	12	13																																																																																											
14	15	16	17	18	19	20																																																																																											
21	22	23	24	25	26	27																																																																																											
28	29	30																																																																																															
S	M	T	W	T	F	S																																																																																											
						1																																																																																											
2	3	4	5	6	7	8																																																																																											
9	10	11	12	13	14	15																																																																																											
16	17	18	19	20	21	22																																																																																											
23	24	25	26	27	28	29																																																																																											
30	31																																																																																																
5	6	7	8	9	10	11																																																																																											
12	13	14	15	16	17	18																																																																																											
19	20	21	22	23	24	25																																																																																											
26	27	28	29	30	31																																																																																												

WEEKLY PRIORITIES

JUNE 29 THRU JULY 5 · 1998



1. Blow the Fuck outta somethin.

Prerecord a logical step-by-step plan throughout your TimeTracker to reach your goals.
Discipline yourself to follow your plan and continually visualize your success.

MONDAY 29	TUESDAY 30	WEDNESDAY
Today's Priorities	Today's Priorities	Today's Priorities CANADA DAY (CANADA)

JULY 6 THRU 19 · 1998

JUNE

S	M	T	W	T	F	S
1	2	3	4	5	6	
7	8	9	10	11	12	13
14	15	16	17	18	19	20
21	22	23	24	25	26	27
28	29	30				

JULY

S	M	T	W	T	F	S
			1	2	3	4
5	6	7	8	9	10	11
12	13	14	15	16	17	18
19	20	21	22	23	24	25
26	27	28	29	30	31	

AUGUST

S	M	T	W	T	F	S
						1
2	3	4	5	6	7	8
9	10	11	12	13	14	15
16	17	18	19	20	21	22
23	24	25	26	27	28	29
30	31					

WEEKLY PRIORITIES

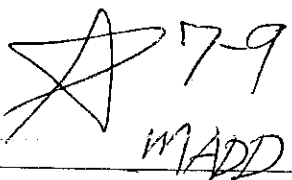
MONDAY 6	TUESDAY 7	WEDNESDAY 8
Today's Priorities	Today's Priorities	Today's Priorities
THURSDAY 9	FRIDAY 10	SATURDAY 11
Today's Priorities	Today's Priorities	Today's Priorities
		
Wheatridge		
		SUNDAY 12
		Today's Priorities

WEEKLY PRIORITIES

I·N·D·I·V·I·D·U·A·L·I·T·Y

The constant pressure to conform to the crowd can be extremely intimidating. It takes real strength to ~~be yourself and stand out from the crowd~~

MONDAY 13	TUESDAY 14	WEDNESDAY 15
<i>Today's Priorities</i>	<i>Today's Priorities</i>	<i>Today's Priorities</i>

JULY 20 THRU AUGUST 2, 1998

JUNE

S	M	T	W	T	F	S
	1	2	3	4	5	6
7	8	9	10	11	12	13
14	15	16	17	18	19	20
21	22	23	24	25	26	27
28	29	30				

JULY

S	M	T	W	T	F	S
			1	2	3	4
5	6	7	8	9	10	11
12	13	14	15	16	17	18
19	20	21	22	23	24	25
26	27	28	29	30	31	

AUGUST

S	M	T	W	T	F	S
						1
2	3	4	5	6	7	8
9	10	11	12	13	14	15
16	17	18	19	20	21	22
23	24	25	26	27	28	29
30	31					

WEEKLY PRIORITIES

MONDAY 20	TUESDAY 21	WEDNESDAY 22
Today's Priorities	Today's Priorities	Today's Priorities
THURSDAY 23	FRIDAY 24	SATURDAY 25
Today's Priorities	Today's Priorities	Today's Priorities
		SUNDAY 26
		Today's Priorities

WEEKLY PRIORITIES

O-P-P-O-R-T-U-N-I-T-Y

What you do, you become. Inspire yourself to attack the opportunity of each new day.

MONDAY 27	TUESDAY 28	WEDNESDAY 29
<i>Today's Priorities</i>	<i>Today's Priorities</i>	<i>Today's Priorities</i>
THURSDAY 30	FRIDAY 31	SATURDAY 1
<i>Today's Priorities</i>	<i>Today's Priorities</i>	<i>Today's Priorities</i>
		SUNDAY 2
		<i>Today's Priorities</i>

AUGUST 1998

SUNDAY	MONDAY	TUESDAY	WEDNESDAY	THURSDAY	FRIDAY	SATURDAY																																																																																				
<p>JULY</p> <table border="1"> <tr><td>S</td><td>M</td><td>T</td><td>W</td><td>T</td><td>F</td><td>S</td></tr> <tr><td></td><td></td><td>1</td><td>2</td><td>3</td><td>4</td><td></td></tr> <tr><td>5</td><td>6</td><td>7</td><td>8</td><td>9</td><td>10</td><td>11</td></tr> <tr><td>12</td><td>13</td><td>14</td><td>15</td><td>16</td><td>17</td><td>18</td></tr> <tr><td>19</td><td>20</td><td>21</td><td>22</td><td>23</td><td>24</td><td>25</td></tr> <tr><td>26</td><td>27</td><td>28</td><td>29</td><td>30</td><td>31</td><td></td></tr> </table>	S	M	T	W	T	F	S			1	2	3	4		5	6	7	8	9	10	11	12	13	14	15	16	17	18	19	20	21	22	23	24	25	26	27	28	29	30	31		<p>SEPTEMBER</p> <table border="1"> <tr><td>S</td><td>M</td><td>T</td><td>W</td><td>T</td><td>F</td><td>S</td></tr> <tr><td></td><td></td><td>1</td><td>2</td><td>3</td><td>4</td><td>5</td></tr> <tr><td>6</td><td>7</td><td>8</td><td>9</td><td>10</td><td>11</td><td>12</td></tr> <tr><td>13</td><td>14</td><td>15</td><td>16</td><td>17</td><td>18</td><td>19</td></tr> <tr><td>20</td><td>21</td><td>22</td><td>23</td><td>24</td><td>25</td><td>26</td></tr> <tr><td>27</td><td>28</td><td>29</td><td>30</td><td></td><td></td><td></td></tr> </table>	S	M	T	W	T	F	S			1	2	3	4	5	6	7	8	9	10	11	12	13	14	15	16	17	18	19	20	21	22	23	24	25	26	27	28	29	30				<p>LUNAR CYCLE</p> <ul style="list-style-type: none"> ● New Moon ◐ First Quarter ◑ Full Moon ◓ Last Quarter 				1
S	M	T	W	T	F	S																																																																																				
		1	2	3	4																																																																																					
5	6	7	8	9	10	11																																																																																				
12	13	14	15	16	17	18																																																																																				
19	20	21	22	23	24	25																																																																																				
26	27	28	29	30	31																																																																																					
S	M	T	W	T	F	S																																																																																				
		1	2	3	4	5																																																																																				
6	7	8	9	10	11	12																																																																																				
13	14	15	16	17	18	19																																																																																				
20	21	22	23	24	25	26																																																																																				
27	28	29	30																																																																																							
2	3	4	5	6	7	8																																																																																				
	★ - 20 hours																																																																																									
9	10	11	12	13	14	15																																																																																				
16	17	18	19	20	21	22																																																																																				
23	24	25	26	27	28	29																																																																																				
30	31																																																																																									

WEEKLY PRIORITIES

AUGUST 3 THRU 9 · 1998



*Prerecord a logical step-by-step plan throughout your TimeTracker to reach your goals.
Discipline yourself to follow your plan and continually visualize your success.*

MONDAY 3	TUESDAY 4	WEDNESDAY 5
<i>Today's Priorities</i>	<i>Today's Priorities</i>	<i>Today's Priorities</i>
THURSDAY 6	FRIDAY 7	SATURDAY 8
<i>Today's Priorities</i>	<i>Today's Priorities</i>	<i>Today's Priorities</i>
		SUNDAY 9
		<i>Today's Priorities</i>

AUGUST 10 THRU 23 · 1998

JULY

S	M	T	W	T	F	S
			1	2	3	4
5	6	7	8	9	10	11
12	13	14	15	16	17	18
19	20	21	22	23	24	25
26	27	28	29	30	31	

AUGUST

S	M	T	W	T	F	S
						1
2	3	4	5	6	7	8
9	10	11	12	13	14	15
16	17	18	19	20	21	22
23	24	25	26	27	28	29
30	31					

SEPTEMBER

S	M	T	W	T	F	S
			1	2	3	4
5	6	7	8	9	10	11
12	13	14	15	16	17	18
19	20	21	22	23	24	25
26	27	28	29	30		

WEEKLY PRIORITIES

MONDAY 10	TUESDAY 11	WEDNESDAY 12
<i>Today's Priorities</i>	<i>Today's Priorities</i>	<i>Today's Priorities</i>
THURSDAY 13	FRIDAY 14	SATURDAY 15
<i>Today's Priorities</i>	<i>Today's Priorities</i>	<p data-bbox="1156 1587 1357 1621">SUNDAY 16</p> <i>Today's Priorities</i>

WEEKLY PRIORITIES

M+E+M+O+R+I+E+S

Give your TimeTracker for future reference. It hasn't
 become a permanent record of your personal activities and
 commitments. Each year you can count on your TimeTracker
 to help identify new challenges and document your experiences.
Time changes!

MONDAY 17	TUESDAY 18	WEDNESDAY 19
<p>Today's Priorities</p> <hr/> <hr/> <hr/> <hr/> <hr/> <hr/> <hr/> <hr/> <hr/> <hr/> <hr/>	<p>Today's Priorities</p> <hr/> <hr/> <hr/> <hr/> <hr/> <hr/> <hr/> <hr/> <hr/> <hr/> <hr/>	<p>Today's Priorities</p> <hr/> <hr/> <hr/> <hr/> <hr/> <hr/> <hr/> <hr/> <hr/> <hr/> <hr/>
THURSDAY 20	FRIDAY 21	SATURDAY 22
<p>Today's Priorities</p> <hr/> <hr/> <hr/> <hr/> <hr/> <hr/> <hr/> <hr/> <hr/> <hr/> <hr/>	<p>Today's Priorities</p> <hr/> <hr/> <hr/> <hr/> <hr/> <hr/> <hr/> <hr/> <hr/> <hr/> <hr/>	<p>Today's Priorities</p> <hr/> <hr/> <hr/> <hr/> <hr/> <hr/> <hr/> <hr/> <hr/> <hr/> <hr/> <p>SUNDAY 23</p> <p>Today's Priorities</p> <hr/> <hr/> <hr/> <hr/> <hr/> <hr/> <hr/> <hr/> <hr/> <hr/> <hr/>

AUGUST 24 THRU 30 · 1998

S	M	T	W	T	F	S
			1	2	3	4
5	6	7	8	9	10	11
12	13	14	15	16	17	18
19	20	21	22	23	24	25
26	27	28	29	30	31	

S	M	T	W	T	F	S
						1
2	3	4	5	6	7	8
9	10	11	12	13	14	15
16	17	18	19	20	21	22
23	24	25	26	27	28	29
30	31					

S	M	T	W	T	F	S
		1	2	3	4	5
6	7	8	9	10	11	12
13	14	15	16	17	18	19
20	21	22	23	24	25	26
27	28	29	30			

WEEKLY PRIORITIES

MONDAY 24	TUESDAY 25	WEDNESDAY 26
<i>Today's Priorities</i>	<i>Today's Priorities</i>	<i>Today's Priorities</i>
THURSDAY 27	FRIDAY 28	SATURDAY 29
<i>Today's Priorities</i>	<i>Today's Priorities</i>	<i>Today's Priorities</i>
		SUNDAY 30
		<i>Today's Priorities</i>



PHONE/ADDRESS DIRECTORY

Name



Name



Name



Name



Name



Name



Name



Name



Name



Name



Name



Name



Name



Name



Name



Name



Name



Name



What you choose to do with your time each day will ultimately determine what you do, what you have, and who you become. Envision, Inc. is committed to developing products that help people count by their ass.

TimeTrackers — \$10⁰⁰

Academic (Aug-Aug)

- 1100E- Elementary School (8.5"x 11")
- 1100M- Middle School (8.5"x 11")
- 1100H- High School (7"x 8.5")
- 1100T- Teacher (7"x 8.5")
- 1100C- Collegiate (7"x 8.5")
- Yearly TimeTracker (Jan-Dec)**
- 1000Y- Yearly (7"x 8.5")

We also carry a wide range of ~~binders~~ binders and accessories to accomodate your ~~needs~~ *mommy*

For more information or to order call

800.622.2385

A.K.A. (1-800-6.CAR.FUK)

MAKETODAY

ENVISION INCORPORATED
 P.O. BOX 2385
 GRAND JUNCTION, CO 81502
 800.622.2385
 FAX 970.243.3004

<http://www.timetracker.com/web>

1997 1998 1999

JULY S M T W T F S 1 2 3 4 5 6 7 8 9 10 11 12 13 14 15 16 17 18 19 20 21 22 23 24 25 26 27 28 29 30 31	JANUARY S M T W T F S 1 2 3 4 5 6 7 8 9 10 11 12 13 14 15 16 17 18 19 20 21 22 23 24 25 26 27 28 29 30 31	JULY S M T W T F S 1 2 3 4 5 6 7 8 9 10 11 12 13 14 15 16 17 18 19 20 21 22 23 24 25 26 27 28 29 30 31	JANUARY S M T W T F S 1 2 3 4 5 6 7 8 9 10 11 12 13 14 15 16 17 18 19 20 21 22 23 24 25 26 27 28 29 30 31
AUGUST S M T W T F S 1 2 3 4 5 6 7 8 9 10 11 12 13 14 15 16 17 18 19 20 21 22 23 24 25 26 27 28 29 30 31	FEBRUARY S M T W T F S 1 2 3 4 5 6 7 8 9 10 11 12 13 14 15 16 17 18 19 20 21 22 23 24 25 26 27 28	AUGUST S M T W T F S 1 2 3 4 5 6 7 8 9 10 11 12 13 14 15 16 17 18 19 20 21 22 23 24 25 26 27 28 29 30 31	FEBRUARY S M T W T F S 1 2 3 4 5 6 7 8 9 10 11 12 13 14 15 16 17 18 19 20 21 22 23 24 25 26 27 28
SEPTEMBER S M T W T F S 1 2 3 4 5 6 7 8 9 10 11 12 13 14 15 16 17 18 19 20 21 22 23 24 25 26 27 28 29 30	MARCH S M T W T F S 1 2 3 4 5 6 7 8 9 10 11 12 13 14 15 16 17 18 19 20 21 22 23 24 25 26 27 28 29 30 31	SEPTEMBER S M T W T F S 1 2 3 4 5 6 7 8 9 10 11 12 13 14 15 16 17 18 19 20 21 22 23 24 25 26 27 28 29 30	MARCH S M T W T F S 1 2 3 4 5 6 7 8 9 10 11 12 13 14 15 16 17 18 19 20 21 22 23 24 25 26 27 28 29 30 31
OCTOBER S M T W T F S 1 2 3 4 5 6 7 8 9 10 11 12 13 14 15 16 17 18 19 20 21 22 23 24 25 26 27 28 29 30 31	APRIL S M T W T F S 1 2 3 4 5 6 7 8 9 10 11 12 13 14 15 16 17 18 19 20 21 22 23 24 25 26 27 28 29 30	OCTOBER S M T W T F S 1 2 3 4 5 6 7 8 9 10 11 12 13 14 15 16 17 18 19 20 21 22 23 24 25 26 27 28 29 30 31	APRIL S M T W T F S 1 2 3 4 5 6 7 8 9 10 11 12 13 14 15 16 17 18 19 20 21 22 23 24 25 26 27 28 29 30
NOVEMBER S M T W T F S 1 2 3 4 5 6 7 8 9 10 11 12 13 14 15 16 17 18 19 20 21 22 23 24 25 26 27 28 29 30	MAY S M T W T F S 1 2 3 4 5 6 7 8 9 10 11 12 13 14 15 16 17 18 19 20 21 22 23 24 25 26 27 28 29 30 31	NOVEMBER S M T W T F S 1 2 3 4 5 6 7 8 9 10 11 12 13 14 15 16 17 18 19 20 21 22 23 24 25 26 27 28 29 30	MAY S M T W T F S 1 2 3 4 5 6 7 8 9 10 11 12 13 14 15 16 17 18 19 20 21 22 23 24 25 26 27 28 29 30 31
DECEMBER S M T W T F S 1 2 3 4 5 6 7 8 9 10 11 12 13 14 15 16 17 18 19 20 21 22 23 24 25 26 27 28 29 30 31	JUNE S M T W T F S 1 2 3 4 5 6 7 8 9 10 11 12 13 14 15 16 17 18 19 20 21 22 23 24 25 26 27 28 29 30	DECEMBER S M T W T F S 1 2 3 4 5 6 7 8 9 10 11 12 13 14 15 16 17 18 19 20 21 22 23 24 25 26 27 28 29 30 31	JUNE S M T W T F S 1 2 3 4 5 6 7 8 9 10 11 12 13 14 15 16 17 18 19 20 21 22 23 24 25 26 27 28 29 30

NEW **HI-POINT CARBINE COMPENSATOR**

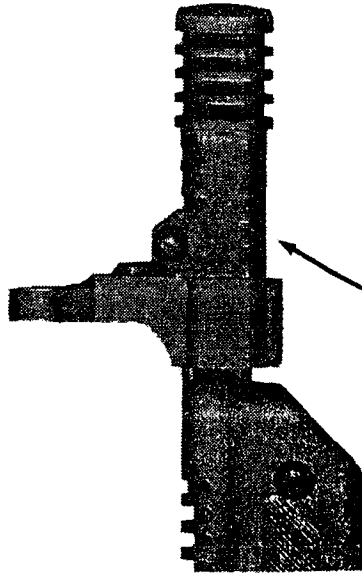

FOR RUSH DELIVERY
Send \$15.00
MONEY ORDER ONLY!
(includes shipping & handling)

To:
HI-POINT FIREARMS
1015 Springmill St.
Mansfield OH
44906

ATTACHMENT GROOVES
(Same as .22 scope mount grooves)

Sporting goods
Goldfish
~~Gross~~ Brun
~~Paper~~ ~~Gross~~ Gross
~~Paper~~ Paper
Gravel
Soda pop
Dog mull
Oatmeal
Kool-aid
Spray paint
Gumbo
Fireworks
Computer monitor
Dylan and Eric
Ending

Blacks

tar babies
porch monkeys
niggers
jungle bunnies
spear chucks
moon crickets
jigaboos
koon
spades
apes
cotton pickers
toasties

slaves

Asian

egg rollers zipperheads
rice farmers charlie
gookes
stick choppers
chinks
starthrowers
monkey
Jews
kikes
candle lighters
kindling
furnace fuel
lab rats

Native Americans

story tellers
cliff dwellers
teepee pitchers
buffalo chasers
hatchet throwers
fire builders
corn grinders
feather bearers

whites

whitey
white trash
mother skunks
the "man"
wigglets
hicks
preps
wife beaters
pigs
pastors
honkies

Latinos

wet backs
boarder hoppers
brownies
taco benders
beaners
burrito wrapper
bricks layers
tequila worms

Middle East

camel riders
sand eaters
desert roamers
terrorists
oil suckers
truck bomb drivers

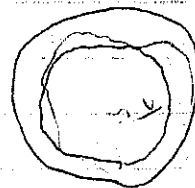
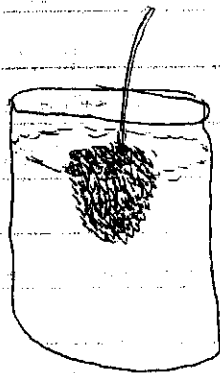

Handwritten scribbles or marks, possibly initials or a signature.

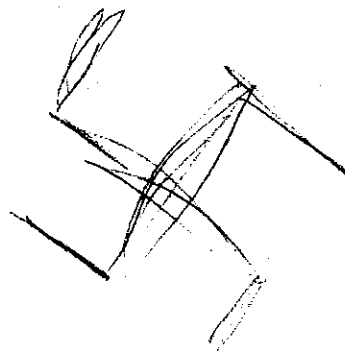
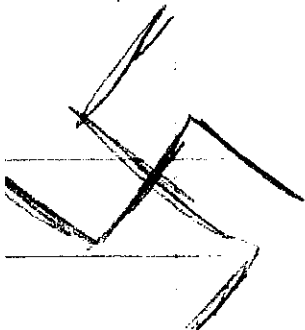
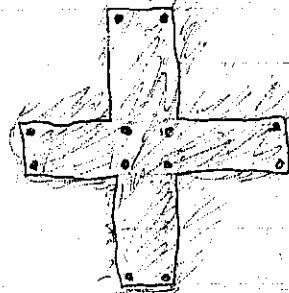

\$279

TRACHCOAT MAFIA

HARRIS

Corporate Presentation Rubric

A. Portfolio	<u>Score</u>
1. Content Is the portfolio complete?	<u>6</u>
2. Mechanics Spelling, punctuation, grammar?	<u>6</u>
3. Organization Does the portfolio flow logically?	<u>6</u>
4. Strength Is the portfolio factual, well developed?	<u>5</u>
5. Aesthetic Does the portfolio look professional?	<u>5</u>
6. Use of class time Did the student use class time effectively?	<u>6</u>

340

B. Presentation	
1. Introduction Is there an effective attention getter?	<u>5</u> <i>COOL OUTPUT.</i>
2. Content Is the presentation factual, developed?	<u>5</u> <i>GOOD COMPANY TRY TO "HOOK" AUD.</i>
3. Clarity Do the speakers know the material?	<u>5</u> <i>YOU DO A GOOD JOB TALKING ABOUT</i>
4. Speaking Skills Does the speaker keep the interest of the class?	<u>6</u> <i>COMPANY. TRY NOT TO</i>
5. Speaker Credibility Do the speakers look and sound credible?	<u>6</u> <i>READ SO MUCH THOUGH. OVERALL, BETTY GOOD</i>

27

C. Visual Aid	
1. Aesthetic Is the VA appealing?	<u>5</u> <i>GOOD QUALITY VIDEO.</i>
2. Clarity Does the VA help presentation?	<u>5</u> <i>LOSE THE LANGUAGE</i>
3. Creativity Is the VA original?	<u>6</u> <i>ADD ITS EFFECT.</i>
4. Content Does the VA keep the interest of the class?	<u>6</u>

220

Total Points:

83/90

Scoring

- 6-Outstanding
- 5-Above Average
- 4-Average
- 3-Below Average
- 2-Pathetic

Grades

- 81-90= A
- 72-80= B
- 63-72= C
- 54-62= D
- 0-53 = F

I think people should learn more about what they are listening to. They need/should actually HEAR what they are listening to every day. People generally listen to music because it "sounds" good. Not many people listen to songs for the lyrics. I think that people should, the band took time to write the song, not just the instrumental part, but the lyric part to. I hear people say things like "Yeah that band rules" or "I love that band their music is so cool!" and they can't even understand what the group is actually talking about. Songs from bands like RAMMSTEIN, KMFDM, NIN, M.M., and more popular ones like the bands played a lot on the radio. People could at least hop on the web and look at the song lyrics or find an English translation so they know what the band is saying, or maybe ask someone who is a big fan and who knows what the band is saying. It's not that hard, and I think it will cut down on a lot of the people in this society that are shallow and naïve who just look at the front cover of the book, and not the pages...to twist around that quote a little.

Everyday events can change a life significantly and we might not even be aware of it. Everything we do, say, and see and everything others do always will affect us, no matter what we think. Therefore, it is hard to say which event in my life has had the most serious, dramatic change. I do believe what happened on the last Friday night in January 1998 is the most significant event that has changed my life. My friend Dylan and I were driving around that night at about 9:00 PM with nothing to do. We decided to go to the a dirt parking lot off of deer creek canyon road to just kind of "hang out" to kill sometime. We were planning to check out some movies, and go home to my house and just spend the night there, just another weekend night. We arrived there, and there were 2 cars, a large white utility van and a small red truck, already parked there. We were the only ones there so we just walked around, broke some bottles we found there, lit off some fireworks, and just talked. Then we began thinking about breaking into this van. No one was around, we had a clear line of sight to anything coming and going, and the van was stuffed with electronic equipment. We thought there was no way we would get caught, and everything seemed so easy. So we got a rather large rock, broke the window and Dylan started removing items from the van while I waited in my car keeping a look out for incoming cars. After about 10 minutes I said "that's enough, let's go." So we left the scene and went up to an open space in the mountains. We were sure we had gotten away with it all, so we started reviewing what we had stolen. I got out of my car to put something in my trunk when a Jefferson County sheriff shined his rather bright flashlight into my eyes from the other side of my car. Right then I realized what a damn fool I was for what I did. He had been watching us for about 5 minutes, apparently he had seen us far away, parked his car down the road, and walked up behind my car without us noticing him. We told him everything, and we were arrested. We spent that entire night waiting for the cops to finish searching my car, waiting at the station and filling out forms and giving statements to the cops, explaining to my parents what we had done and why, and then going up to Golden to get "booked." After a very unique experience in a real live police station being a real live criminal, I had lots of time to think about what I did. Remorse put it lightly. I spent about 4 hours there, only about 15 minutes of that was I actually doing something, like giving them any and every imaginable way of taking my fingerprints, or taking my picture. Actually, mug shot would be a more appropriate word. I waited for the rest of the time. Their computer chose that moment to break down, so they put me into prison-type bathroom to wait. As I waited, I cried, I hurt, and I felt like hell. We got home at about 4:30 AM that morning. My parents lost all trust in me, and were completely disappointed beyond belief. April is when our court date finally came around, and we were both sentenced to 1 full year of diversion. Which is a lesser charge since we plead guilty to all charges. So, the consequences of that night were; 1

Eric Harris
Period 2, T-dog.
11/19/98

year diversion which includes about 350 dollars worth of fines, a total of 4 full days of classes such as anger management and mother against drunk driving, 45 hours of community service, 2 months grounding, 120 dollar fine for getting my car back (it was impounded), and I am seeing a psychologist to help me with my anger problems. I am glad neither of us drink or do drugs, because that would have sky rocketed our already orbit-level consequences. My parents lost all respect and trust in me and I am still slowly regaining it. That experience showed me that no matter what crime you think of committing, you will get caught, that you must, absolutely must, think things through before you act, and that just because you can do something doesn't mean you should. To this day I still do not have a hard realistic reason why we broke into that car, but since we did, we have been set on a track that makes it mandatory for me to be a literal angel until March of '99. So that will hopefully keep me out of any trouble that I would have gotten into my senior year. Personally, I think that whole entire night was enough punishment for me. On the good side, I have had many new experiences that I am sure will help me with life as a result of being on diversion. So all in all, I guess it was a worth while punishment after all.

Eric,

Wow what a way to learn a lesson. I agree that night was enough punishment for you. Still, I am proud of you and the way you have reacted to this situation. We all make mistakes, how we respond to them is what makes us who we are. You have really learned from this and it has changed the way you think. This may be the best lesson you ever learn. I also think you should know that it's not one action that makes a person who they are. I would trust you in a heartbeat. Thanks for letting me read this and for being in my class.

Sincerely,
Tonelli

Third Reich Acronyms, Etc. Info

NSDAP- National Socialist German Workers' Party
(Nationalsozialistische deutsche Arbeiter Partei)- The Nazi Party.

SS-Schutzstaffel (Protective Squads)- An elite paramilitary organization, formed in 1923, that began as a small group of bodyguards protecting the führer and developed into a party police force, a terrorist Reich police force, and a regular army within the army (Waffen-SS). The SS was a huge economic conglomerate that reached into German businesses, and it was also to an extent a gigantic murder machine that supervised a far-flung system of concentration camps in which people were tortured and annihilated. Under Heinrich Himmler, the SS became a state within a state, and its blackshirted members formed a tight-knit fraternity of racial true believers.

HJ-Hitlerjugend (Hitler Youth)- A youth organization of the NSDAP that forcibly amalgamated all youth groups in the Third Reich. Under the leadership of Baldur von Schirach, the HJ encompassed: the Deutsches Jungvolk (German Young Folk), who were the ten- to fourteen-year-olds; the Jungmädelsbund (League of Young Girls), girls aged 10 to 14; Bund deutscher Mädel (League of German Girls) and the HJ of 15 to 18 year-olds.

DAF- Deutsche Arbeitfront (German Labor Front)- Labor organization, sponsored by the National Socialists, that replaced the various labor unions of the Weimar Republic. Headed by Robert Ley, the DAF encompassed all of German labor, reaching a membership of more than twenty million. Its function was to bring about a lasting harmony between contending socioeconomic interest groups and to protect the rights of labor. It provided financial assistance to workers, set wages, and used its funds to improve the lives of German workers. Operating with a large budget, the DAF also developed various branches such as the Strength through Joy (Kraft durch Freude) movement, which provided holidays to workers at inexpensive rates, and the Beauty of Labor (Schönheit der Arbeit) office, which tried to improve working conditions in plants and factories.

OT-Organization Todt- The primary building (construction, architecture, etc.) arm of the Third Reich.

NSKK-Nationalsozialistisches Kraftfahrkorps- The transportation arm of the Nazi Party.

NSFK-Nationalsozialistisches Fliegerkorps- The group that dealt with aviation matters for the Third Reich.

Afrika Korps-The various military formations sent by Hitler to aid the Italians in N. Africa. Under the command of General Rommel since Feb. 1941, the Afrika Korps fought valiant battles against the British and later against combined Anglo-America forces, but was decisively beaten by the spring of 1943.

Aktion Reinhard-Code name for the annihilation of Jews in the Polish territory administered by the Nazis. The operation was named in "honor" of SD chief Reinhard Heydrich, who was assassinated in Prague on May 27, 1942.

Aktion T4-Code name for the actions taken in the euthanasia program that led to the killing of one hundred thousand "lives not worth living" (mentally retarded men, women, and children). It was named after the relevant government department of the Reich chancellery located on Tiergarten Strasse 4 in Berlin.

Anschluss- The annexation of Austria by the Nazis in February 1938 and its incorporation as a province (Ostmark) into the German Reich.

Barbarossa- Code name for the German attack on the Soviet Union on June 22, 1941.

BDM-Bund deutscher Mädel (League of German Girls). A subdivision of the Hitler Youth. The Hitler Youth had a male and female division. The latter was subdivided into the League of Young Girls (10-14) and the League of German Girls (15-18). {See HJ}

Berghof- Adolf Hitler's Bavarian home at the Obersalzberg, NE of Berchtesgarden.

Blut and Boden- (Blood and Soil)- A term used to describe the fundamental Nazi belief that a healthy nation presupposes a people of common blood living on its own soil. The overuse of the term by Nazi ideologues prompted many Germans to refer to such blood and soil propaganda as "Blubo."

Dachau- The site of the first National Socialist concentration camp located about 10 miles NW of Munich. Opened in March 1933, it housed a variety of prisoners- Socialists, Communists, Jews, Gypsies, homosexuals- who were held in "protective custody." The camp expanded steadily and became one of the most notorious camps in Germany. During WWII the number of inmates grew to about seventeen thousand, some of them being used for cruel medical experiments.

Einsatzgruppen- Special battalion-sized mobile units of security police and SD officials that conducted police and terroristic actions behind and alongside the regular German army. During the Russian campaign four *Einsatzgruppen* were attached to Army Group North, Center, South, and the Eleventh Army. Their functions were to round up Communist functionaries, "Asiatic inferiors," and Jews and herd them into concentration camps or conduct brutal liquidations on the spot. It is estimated that these killer troops murdered close to one million people, mostly Jews, in mass executions and later helped to kill five million additional victims in annihilation camps.

Endlösung- (final solution)- Euphemistic code word for the "final solution of the Jewish Question," or the program involving the annihilation of six million Jews.

Führer-(leader)- Term chosen by the Nazi Party and later by all German authorities to describe their supreme leader, Adolf Hitler.

Führerprinzip- (leadership principle)-Antidemocratic belief that efficiency in government or businesses can only be achieved when leaders (führers) are fully empowered to do what they are assigned to do by their immediate supervisors. Only the highest führer is responsible to the people through plebiscitarian measures, but otherwise delegates strong führer power (*Führergewalt*) to his subordinates who, in turn, delegate it to their subordinates.

Gauleiter-(party district leader[s])- The highest ranking Nazi official below the *Reichsleiter*. Directly responsible to Hitler, the *Gauleiter* were in charge of all economic and political activities in their districts (*Gaue*). During the war, they were also responsible for civil defense. Many *Gauleiter* also served as *Reichsstatthalter*, or provincial governors, thus fusing state and party offices.

Gestapo-(Geheime Staatspolizei)- The terrorist police force developed out of the Prussian police department called "security police" (Sipo); it was greatly expanded under Göring's tutelage by his assistant Rudolf Diels. When Himmler coordinated all the police forces of Germany under his control in 1933-34, he also took charge of the Gestapo and transformed it into one of the most dreaded organizations of intimidation and terror. Putting Heydrich in charge, Himmler managed to detach the Gestapo from any effective control by constituted legal authorities. The primary mission of the Gestapo was to identify enemies of the state, put them into "protective custody" (*Schutzhaft*), use any methods deemed necessary to extract information, and consign such enemies to prison or concentration camps.

Kristallnacht- (Night of Crystals)- Refers to the night of Nov. 9-10, 1938, when the Nazis instigated widespread attacks on Jewish synagogues, businesses, and homes throughout Germany, on the pretext of this being retaliation for the assassination of Ernst vom Rath, secretary to the German legation in Paris, by a Jewish protestor, Herschel Grynszpan, whose parents along with many former Polish Jews in Germany were being forcibly evicted.

KZ-German abbreviation for *Konzentrationslager* or concentration camps.

Lebensborn-(Life Springs)- An SS organization, founded in 1935, that provided safe homes for women, married or unmarried, who had children by SS men. Located in out of the way places, these homes also functioned as stud farms where suitable German women could mate with equally suitable SS "assistants of conception." By 1944 almost eleven thousand children were born in thirteen Life Springs homes. In addition, these homes served as conduits for Himmler's criminal program of kidnapping Aryan-type children in the eastern territories and finding adoptive parents for them in Germany.

Napolas-(National Political Institutes of Education)-Elite party schools designed to train future government leaders.

NSBO-(National Socialist Factory Cell Organization)- A proto-union wing of the NSDAP whose aim was to wage propaganda in business and industrial plants in order to win the workers over to National Socialism.

Obersalzberg- A one-thousand-meter mountain NE of Berchtesgarden on which Hitler constructed his private villa, the Berghof.

OKH-(Oberkommando des Heeres)-High Command of the Army.

OKL-(Oberkommando der Luftwaffe)-High Command of the Air Force.

OKM-(Oberkommando der Kriegsmarine)-High Command of the Navy.

Orpo-(*Ordnungspolizei*) Order Police- Police branch that had been separated by Himmler from the Gestapo and the criminal police. Led by Kurt Daluge, the order police forces handled routine business such as traffic, patrols, and other police matters in both city and rural areas. Some of the "order police" units, however, were involved in mass atrocities in Poland and Russia, functioning like *Einsatzgruppen*.

RAD-Reichsarbeitsdienst (State Labor Service)- The Third Reich's equivalent to the Civilian Conservation Corps in the U.S. The two groups were founded around the same time for similar reasons-widespread unemployment throughout the country, economic depression, etc. RAD did the same things CCC did, like working on roads, bridges, and such. When RAD was first founded in 1931, it was called Freiwilliger Arbeitsdienst (FAD), and taking part was optional. When the Nazis first came to power, the name was changed to National Socialist Labor Service, and finally in 1934 it was altered to the final RAD, and participation was mandatory for certain age groups, who served for a set time period.

Reichsleiter-(Reich Leader)- The highest functionary in the Nazi Party, who exercised sweeping powers in his particular field. Appointed by Hitler, the *Reichsleiter* formed the highest level of the party, collectively called the *Reichsleitung*.

Reichstatthalter-(Reich Governor)- Agent or commissioner of the Reich government who was responsible for supervising a state government. These officials were empowered to appoint and dismiss state officials and to monitor whether individual state governments were in compliance with the Reich government. Most Reich governors were also *Gauleiter* and thus directly responsible to Hitler.

RSHA-(Reichssicherheitshauptamt) Reich Main Security Office-The super security agency of the SS created on Sept. 27, 1939, and headed by Reinhard Heydrich.

RuSHA-(Rasse und Siedlungshauptamt) Main Office of Race and Settlement of the SS.

SA-Sturmabteilung (Storm Detachment)- Hitler's private army of brownshirted storm troopers who safeguarded Nazi meeting halls, served as bodyguards to party leaders, fought street battles with members of the opposition, and acted as political foot soldiers distributing leaflets, begging for donations, and pounding the pavement for votes in support of the führer.

SD-(Sicherheitsdienst) Security Service- The intelligence service of the SS headed by Reinhard Heydrich. Its function was to discover the enemies of National Socialism and ideally arrest them before they had done anything wrong. Mushrooming into a grotesque bureaucracy of professionals, informants, and sadists, this terroristic police and "thought control" agency became not only an instrument of totalitarian control but also one of the chief executive organs of the annihilation of Jews, Gypsies, Communists, and "Asiatic inferiors."

Sipo-(Sicherheitspolizei) Security Police- The security police force consisting of the Gestapo, the criminal police, and border police. Heydrich fused the Sipo with the SD when he became head of the Reich Main Security Office (RSHA).

Völkisch-(National- or ethnic-mindedness)- The term denotes a sense of Germanic ethnocentrism, cultivated by hosts of nationalistic movements before and after WWI. The Nazis represented the extreme expression of such tribal feelings and beliefs.

Völkischer Beobachter-(Ethnic/racial observer)-The official newspaper of the NSDAP, published with only a short interruption (1924) from 1919 to 1945 and edited throughout much of this period by Alfred Rosenberg.

Waffen-SS-(Armed SS)-Term used to describe the fighting arm of the SS. These were well-trained soldiers who fought on the front line of the most dangerous and vital battles of the war.

Wannsee Conference-(January 20, 1942)- A top-secret government conference, chaired by Heydrich and attended by major representatives involved in Jewish affairs (Eichmann, Stuckart, Luther, Freisler). It was during this conference that the technical means of bringing

about the "final solution" to the Jewish question were discussed. The participants all agreed that the Jews represented a deadly biological health hazard and therefore had to be exterminated. The overall plan was to conduct a thorough sweep of Jews in the whole of Europe and transport them to the five major annihilation camps at Auschwitz, Belzec, Treblinka, Sobibor, and Majdanek. The Wannsee Conference was not the initiation of the final solution- that had already begun with mass shootings two years before- but a cooperative effort by which major state organizations agreed on common procedures of implementing the annihilation of European Jews.

Wehrmacht-(Armed Forces)- Term first used in 1935 to refer collectively to the branches of the German military- army, navy, and air force.

It was Himmler's master stroke that he succeeded in indoctrinating the SS with an apocalyptic 'idealism' beyond all guilt and responsibility, which rationalized mass murder as a form of martyrdom and harshness towards oneself. Nowhere was this more apparent than in Himmler's notorious speech on 4 October 1943 to the SS Group Leaders in Poznan.

'One principle must be absolute for the SS man: we must be honest, decent, loyal, and comradely to members of our own blood and to no one else. What happens to the Russians, what happens to the Czechs, is a matter of utter indifference to me. Such good blood of our own kind as there may be among the nations we shall acquire for ourselves, if necessary by taking away the children and bringing them up among us. Whether the other peoples live in comfort or perish of hunger interests me only in so far as we need them as slaves for our Kultur. Whether or not 10,000 Russian women collapse from exhaustion while digging a tank ditch interests me only in so far as the tank ditch is completed for Germany. We shall never be rough or heartless where it is not necessary; that is clear. We Germans, who are the only people in the world who have a decent attitude to animals, will also adopt a decent attitude to these human animals, but it is a crime against our own blood to worry about them and to bring them ideals. I shall speak to you here with all frankness of a very grave matter. Among ourselves it should be mentioned quite frankly, and yet we will never speak of it publicly. I mean the evacuation of the Jews, the extermination of the Jewish people. . . . Most of you know what it means to see a hundred corpses lying together, five hundred, or a thousand. To have stuck it out and at the same time - apart from exceptions caused by human weakness - to have remained decent fellows, that is what has made us hard. This is a page of glory in our history which has never been written and shall never be written.'

The document described below
has been removed

Description of Document: Pine, Lisa,
“Nazism in the Classroom,” History
Today, April 1997, pg. 22

Date of Document: April 1997

Reason for Removal

- Copyright
- Bomb-making instructions
- Medical Records
- Other

Comments: _____

How many people can a football stadium hold? Can it hold fifty, sixty thousand?

Most stadiums can. Now, picture a stadium filled, not just seats but the field and all the air above it, with dead men, women, and children. That is just a fraction of the casualties inflicted by the Nazis, also known as the Third Reich. Through the 1920s and 1930s ideas from the past and basically anything that seemed interesting to Adolf Hitler was added into the government policies. [Nazism was a form of government not like any other in history, with their beliefs and policies, their very strong family values, and the plans they had in store for the rest of the world.]

I
The number of deaths the Nazis are responsible for will never be known, however it is believed that from the concentration camps alone, over eleven million people lost their lives. Add on a couple hundred thousand casualties from armies all over the world, including Germany's, and it comes out to be an amount most people today cannot even picture. The Third Reich almost completely wiped out the Jewish population in Europe in the late 1930's and early 1940's. Now in our minds, that is utterly inhumane, immoral, and evil, but in the Nazi's minds, it was perfectly fine to exterminate an entire race. Day after day Nazi officers would casually make remarks about executions and horrors they witnessed, as an every-day joke. [The Nazis ^{are} were considered evil by the majority of the world's population because of the ^{treatment of Jews} death they caused, the beliefs they had, and even the symbols they used in propaganda.]

A
The Nazis had a distinct hatred for the Jewish race. They wanted the entire race exterminated and the best, most efficient way of doing this was to make concentration camps. Nazi doctors ruled most of the concentration camps. Doctors like Mengele were considered as "... a non-human, evil force... the lord of life and death" (Lifton 345). In

Eric Harris

the earlier years, shootings were the more "popular" way of disposing of Jews, *despite the fact that most of the shootings were in places - barbers, etc.*

Sometimes twisted Nazi officers would line up prisoners and fire a rifle round into the first just to see how many chests it would go through. As time passed gas chambers and crematoriums became responsible for most of the killing. An SS guard once said, "the killing way easy...they just went in expecting to take showers and instead of water we turned on poison gas" (Infield 76). Gassing was indeed the most efficient method.

"...The occasional emotional difficulties encountered by the executioners, who might balk at shooting children, for instance, gassing proved by far the most efficient method," (Remak 158) says an SS guard in regards to gas chambers. Methods of killing did vary. In a city called Riga convicts were released, given iron bars, and ordered to kill Jews (Remak 152). The hatred was constantly reinforced through speeches from people like Hitler and Himmler. Himmler once said "whether or not 10,000 Russian women collapse from exhaustion while digging...interests me only in so far as the ditch is completed for Germany," ("History") which basically says that all he cares for, and all he wants everyone else in Germany to care for, is Germany. The amount of hatred for the Jewish

race was incredible. The Nazi's hatred "was symbolized for them by the Jews," who very often became targets, scapegoats, and the usual suspects (Thornton 10). Nazis constantly insulted the Jewish race. It helped them to build the hatred for the Jews.

Public speeches like "the Jew is... a parasite, a sponger... a pernicious bacillus... his presence is also like that of a vampire; for whenever he established himself [,] the

people... are bound to be bled to death..." (Thornton 10) were also used to boost the *German people* hatred in Germany. *It was all part of their beliefs and they saw nothing wrong with it.* In

order to maintain their government the Jewish race had to be forced out of the picture.

3
"The inhuman persecution of the Jews that the Nazis carried out was firmly based on their view of life," and therefore, in their own minds, killing was right (Thornton 5). The Nazis were not fond of communism either. Since communism was basically on the other side of the political spectrum from the Nazis, they wanted to get rid of communism altogether. ⁽⁷⁻³³⁾ Conquering Russia, the "heartland" of communism, would have had two different positive outcomes for the Nazis. One would be the end of communism, or at least that is what they thought, and the other would be that Russia would provide a large amount of living space for German farmers and workers. Hitler once said, "the threat of communism... could only be dealt with ultimately by the destruction of the communist homeland, Russia," which is why Germany attacked Russia (Smith 235). The Nazi views on the Jews and the communists were full of hate, and the concentration camps and the other methods of dealing death was all part of the Nazi policy, and a part of today's natural hatred towards Nazis.

Some people ask, "how did such an evil empire come to be?" and the answer is simple, Germany needed a leader, and Hitler was the best leader Germany had. His persuasive, manipulative speeches and his promises for a great nation were enough to get almost the entire German community to strongly support him. ⁽³⁻¹²⁾ The Germans wanted something to be proud of, and Hitler was able to provide it for them. With Hitler saying things like, "the common interest before self interest," and "love Germany more than anything, and your fellow Germans more than yourself!" all helped the German people feel like they were part of something special and exciting (Remak 39). They were glad to see Germany being brought out of the depression before World War II. Germany, "under the Nazi regime," was overcoming the effects of the great depression (Remak 75). This

The SA loved Hitler even though his order. (whether war or peace) suppressed all written laws.

boosted the community's moral. Hitler got the Germans moving again, he gave them something to strive for. A certain energy, "...a feeling that things were moving again, that a new energy had been infused into German life," as described by one citizen, was moving through Germany (Remak 71). A new social structure was being formed, with Hitler and his ideas at the top.

The Nazis used several ancient runes in their flags and military signs, along with special code words used by officers. The swastika itself, a symbol imbedded into many minds as a symbol of evil, was derived from an ancient rune known as a *Hakenkreuz*. It was a Pagan Germanic symbol of the God of Thunder known as Donnor, or Thor ^{Its red background indicated its "social idea of the movement." and the white circle indicated its "nationalism." (S-25)} ("Histroy"). The Nazi's "SS" symbol was also an ancient Pagan rune, known as a *sig-rune*. By itself the sig-rune was only one large lightning bolt-type "S" which symbolized victory ("History"). A badge manufacturer, who just put two of the *sig-runes* together, made the discovery of the "SS" symbol. Code words, such as Aktion T4 and KZ were used often by Nazi officers. Aktion T4 was the code name of the euthanasia program that led to the killing of approximately 100,000 lives that were "not worth living." Aktion T4 was named after the relevant government department of the Reich chancellery located on Tiergarten Strasse 4 in Berlin ("Histroy"). KZ stood for Konzentrationslager, which means concentration camp in English. It was used constantly by Nazi officers and soldiers to somewhat lessen the idea of the camps, and what they were used for ("Histroy"). The Third Reich was definitely a unique government, using symbols from ancient Pagan runes and coming up with entirely new and extremely racist laws.

Racism was rooted into the Nazi government just like freedom is rooted in America's government. Laws for censorship, foreigners, and duties of citizens were all

Hitler even once ~~stated~~ stated that "We have to put a stop to the idea that it is a part of everybody's civil rights to say whatever he pleases." (9-83)

Eric Harris
Period 5
Webb (1-1)

~~the concepts of "racial superiority, national community, and leadership" all stood at the center of the Nazi Weltanschauung.~~ warped around protecting the state.) Strong censorship was imposed in Germany, against

books, articles, magazines, films, and even art. Nazi rulers had complete control over what they wanted their citizens to be seeing, hearing, and reading. They indeed "... had a free hand to determine[,] if it could, every man's attitude toward life," (Moose xxi).

Euthanasia is a popular topic in today's American society, but in Nazi Germany, all mentally disabled people or people with "incurable mental defectives" were killed due to

the Aktion T4 project, more commonly known as the Euthanasia project (5-28)

A citizen had strict duties, and at the top of their list was to work for the good of the state (Thornton

24). Aliens, on the other hand, were to be discriminated against. The German people

wanted only pure German people in their country, any others were to be "disposed of."

Therefore, foreigners had few rights, and Jews in particular were to be hated (Thornton

24). The concepts of racial superiority, national community, and leadership were most popular in the Nazi's *weltanschauung*, or world view (9-120)

(1-1) Education was not made to benefit the individual, but to benefit the state. Education was used to make a more perfect

generation of Germans, who were strong and prepared to sacrifice and undertake responsibilities towards the nation community (Pine 1). The security and preservation of

the state and its ideals always came first; the individual was a far second.

Family values in Nazi Germany were very strong. Germans wanted to keep their families strong, healthy, and active. Education was revised, the woman's role was changed, and the overall Aryan racial elements were outlined in order to have a more perfect, flawless community.

Education was very important for Hitler's youth. He wanted the highest task of education to be the preservation, care, and development of the best racial elements (Pine

1). In order to do this, textbooks and schools need to be reformed. Nazi symbols were inserted into books, pictures of Hitler with children were posted in schools, and eventually school children were putting swastikas in their homes (Pine 2). Scientific and arithmetic examples in textbooks also helped the youth with their racial superiority education. Craniology, the study of the skull, was used to show the ^{differences between and} inferior races ~~and~~ superior races (Pine 4). Arithmetic was used to show how "wasteful" the mentally challenged were and how much money could be saved by euthanasia (Pine 5). These ideas were then transferred to German homes where parents could learn about their roles in the Third Reich.

The woman's role, in particular, was very unique. Through out time women have tried to be treated as equals to males. Eventually they did win their rights in America, but in Nazi Germany, the women were supposed to be "glad" to stay home and cook and clean all day long. ^{It was said to be in the front of "patriotic as well as moral virtues" 4-185} Women were required to raise the children, cook, clean, and look after the house. ^{It was also "good morals for a woman to have several children."} They could not join in politics, nor serve in the armed forces. This was all part of the superior Aryan race and was considered to be the law.

The Aryan race was considered to be the superior human race. All others were inferior and were constantly criticized. Extreme racism was used to show the Nazi's superiority. The personal characteristics of the Aryan race included honor, courage, love of freedom, and a strong spirit of scientific research (Thornton 5). Physically, the Aryans were tall, strong, and long-headed. They had blue eyes and blond hair, with a fair skin complexion (Thornton 5). Many attempts were made to increase the "pure" German blood population, such as stealing children who matched the physical requirements of the Aryan race from their homes. Himmler once responded to a question that asked "how

C
can we be so cruel as to take a child from its mother," by saying "how much more cruel [is it] to leave a potential genius with our natural enemy," (Infield 138). The Nazis were very determined in forming a perfect German nation.

Breeding became a controlled issue in the Third Reich. Only the elite would reproduce (Pine 1). It became against the law for a pure-German person to breed with someone who was not. The goal was to bring together a high-grade heredity stock and to eliminate all inferior races from the German people (Moose 35). They believed that because of inferior races, like the Jews, many true German families were ruined by the result of only one "low-grade" person coming into the family. Once again, it was the Jews' fault for Germany's problems.

H
The Nazi regime was defeated, but most of the leaders fought it out until the end, still turning out new plans and more secret weapons. Hitler had many plans for the future that he would never see accomplished. He had plans for Europe, for Russia, and eventually for the whole world.

A
Hitler's main goals were to conquer Europe and form a perfect Aryan nation. A nation would be created that would thrive on National Socialism. He also wanted to conquer Russia and use the land for farming. The people would be able to live free, just as long as the Germans were their rulers. In case of a revolution, they would "drop a few bombs on their cities and the affair will be over" (Remak 128). Those types of events show the care, or lack there of, for the people of other nations besides Germany. Eventually, if Hitler would have won the war, the Third Reich would have spanned over the whole globe and tens of millions of more people would have been eliminated.

B
ONE

Eric Harris
Period 5
Webb

The Third Reich, led by Adolf Hitler, was one of the most evil and racist forms of government ever, and as a result of this, millions upon millions of people lost their lives.

The concentration camps, the racist views, the Final Solution, and many new German policies were all part of Hitler's master plan of creating a perfect Aryan race to rule Germany.

Works Cited

"Histroy." Online. Available:

25 October 1998.

Infield, Glenn B. Secrets of the SS. Stein and Day. Braircliff Manor, NY. 1981.

Lifton, Robert Jay. The Nazi Doctors. Robert Jay Lifton, 1986.

Moose, George L. Nazi Culture. New York: Grosset and Dunlap, 1966.

Nyomarkay. The Nazi Party. University of Minnesota, 1967.

Pine, Lisa. "Nazism in the Classroom". History Today April 1997: 22-28.

Remak, Joseph. The Nazi Years. Prentice-Hall Inc. Englewood Cliffs, NJ. 1969.

Schoenbaum, David. Hitler's Social Revolution. Doubleday Company, Inc., Garden
City, New York, 1966.

Smith, Woodruff D. The Ideological Origins of Nazi Imperialism. New York:
Oxford University Press, 1986.

Thornton, M. J. Nazism. Pergamon Press Ltd., 1966.

How many people can a football stadium hold? Can it hold fifty, sixty thousand?

Most stadiums can. Now, picture a stadium filled, not just seats but the field and all the air above it, with dead men, women, and children. That is just a fraction of the casualties inflicted by the Third Reich. The Third Reich almost completely wiped out the Jewish population in Europe. Now in our minds, that is utterly inhumane, immoral, and evil, but in the Nazi's minds, it was perfectly fine to exterminate an entire race. Day after day Nazi officers would casually make remarks about executions and horrors they witnessed, just for fun. Nazism itself was hardly even a well-organized form of government. Through the 1920s and 1930s ideas from the past and basically anything that seemed interesting the Adolf Hitler was added into the government policies. Nazism was a form of government not like any other in history, with very strong family values, strict guidelines, educational standards, and racial beliefs.

The number of deaths the Nazis are responsible will never be known, however it is believed that from the concentration camps alone, over 11 million people lost their lives. Add on a couple hundred thousand casualties from armies all over the world, including Germany's, and it comes out to be an amount most people today cannot even picture. The Nazis were considered evil by the whole world, because of the death they caused, the beliefs they had, and even the symbols they used in propaganda.

The Nazis had a distinct hatred from the Jewish race. They wanted the entire race exterminated and the best, most efficient way of doing this was to make concentration camps. Nazi doctors ruled most of the concentration camps. Doctors like Mengele, who were considered as "... a non-human, evil force... the lord of life and death," (Lifton 345). Gas chambers and crematoriums were responsible for most of the killing, but in the

earlier years, shootings were the more "popular" way of disposing of Jews. As one SS guard once said, "the killing way easy... they just went in expecting to take showers and instead of water we turned on poison gas," (Infield 76). Gassing was indeed the most efficient method. "...The occasional emotional difficulties encountered by the executioners, who might balk at shooting children, for instance, gassing proved by far the most efficient method," (Remak 158) says another SS guard. The methods did vary, sometimes twisted Nazi officers would line up prisoners and fire a rifle round into the first just to see how many chests it would go through. Another example is that one time in a city called Riga; convicts were released, given iron bars, and told to kill Jews (Remak 152). The hatred was constantly reinforced through speeches from people like Hitler and Himmler. Himmler once said "whether or not 10,000 Russian women collapse from exhaustion while digging... interests me only in so far as the ditch is completed for Germany," (History) which basically says that all he cares for, and all he wants everyone else in Germany to care for, is Germany. The amount of hatred by the Nazis is

incredible, especially for the Jewish race. "Everything the Nazis hated was symbolized for them by the Jews," and so the Jews were often targets, scapegoats, and the usual suspects (Thornton 10). Nazis constantly insulted the Jewish race. It helped them to build the hatred for the Jews. Public speeches like "the Jew is... a parasite, a sponger... a pernicious bacillus... his presence is also like that of a vampire; for whenever he established himself (,) the people... are bound to be bled to death..." (Thornton 10) were used to boost the hatred also. It was all part of their beliefs. In order to maintain their government the Jewish race had to be forced out of the picture. "The inhuman persecution of the Jews that the Nazis carried out was firmly based on their view of life,"

and therefor, in their own minds, killing was right. The Nazis were not fond of communism, either. Since communism was basically on the other side of the political spectrum from the Nazis, they wanted to get rid of communism altogether. Conquering Russia, the "heartland" of communism, would have had two different positive outcomes for the Nazis. One would be the end of communism, or at least that is what they thought, and the other would be that Russia would provide a large amount of living space for German farmers and workers, which is what they were looking for. Hitler once said that "the threat of communism... could only be dealt with ultimately by the destruction of the communist homeland, Russia," and therefor, that is the reason behind Germany attacking Russia. The Nazi views on the Jews and the communists were full of hate, and the concentration camps and the other methods of dealing death was all part of the Nazi policy, and a part of today's natural hatred towards Nazis.

Some people ask, "how did such an evil empire come to be?" and the answer is simple, Germany needed a leader, and Hitler was the best leader to offer. His persuasive, manipulative speeches and his promises for a great nation were basically enough to get the whole German community behind him. The Germans wanted something to be proud of, and Hitler gave it to them. Saying things like "the common interest before self interest," and "love Germany more than anything, and your fellow Germans more than yourself!" all helped the German people feel like they were part of something special and exciting. They were glad to see Germany being brought out of the post-World War II depression. "Germany, under the Nazi regime, was overcoming the effects of the great depression," this boosted the community's moral (Remak 75). Hitler got the Germans moving again, he gave them something to strive for. A certain energy, "... a feeling that

things were moving again, that a new energy had been infused into German life," as described by one citizen, was moving through Germany (Remak 71). A new social structure was being formed, with Hitler and his ideas at the top.

The Nazis used several ancient runes in their flags and military signs, along with special code words used by officers. The swastika itself, a symbol imbedded into many minds as a symbol of evil, was derived from an ancient rune called a *Hakenkreuz*. It was a Pagan Germanic symbol of the God of Thunder known as Donnor, or Thor (Histroy). The Nazi's "SS" symbol was also an ancient Pagan rune, known as a *sig-rune*. By itself the sig-rune was only one large lightning bolt-type "S" which symbolized victory (History). A badge manufacturer, who just put two of the *sig-runes* together, discovered the "SS" symbol. Code words, such as Aktion T4 and KZ were used often by Nazi officers. Aktion T4 was the code name of the euthanasia program that led to the killing of approximately 100,000 lives that were "not worth living." Aktion T4 was named after the relevant government department of the Reich chancellery located on Tiergarten Strasse 4 in Berlin (Histroy). KZ, which stood for Konzentrationslager, was used constantly by Nazi officers and soldiers, to somewhat lessen the idea of the camps, and what they were used for (Histroy). The Third Reich was definitely a unique government, using symbols from ancient Pagan runes and coming up with entirely new and extremely racist laws.

Racism was rooted into the Nazi government just like freedom is rooted in America's government. Laws for censorship, foreigners, and duties of citizens were all warped around protecting the state. Strong censorship was imposed in Germany, against books, articles, magazines, films, and even art. Nazi rulers had complete control over

what they wanted their citizens to be seeing, hearing, and reading. They indeed "...had a free hand to determine if it could, every man's attitude toward life," (Moose xxi).

Euthanasia is a popular topic in today's American society, but in Nazi Germany, all mentally disabled people or people with "incurable mental defectives" were killed due to the Aktion T4 project, or more commonly known as the Euthanasia project. A citizen had strict duties, and at the top of their list was to work for the good of the state (Thornton 24). Aliens, on the other hand, were to be discriminated against. The German people wanted only pure German people in their country, any others were to be "disposed of." Therefore, foreigners had few rights, and Jews in particular were to be hated (Thornton 24). The concepts of racial superiority, national community, and leadership were most popular in the Nazi's *weltshauung*, or world view. Education was not made to benefit the individual, but to benefit the state. To make a more perfect generation of Germans, who were strong and prepared to sacrifice and undertake responsibilities towards the nation community (Pine 1). The security and preservation of the state and its ideals always came first; the individual was a far second.

Family values in Nazi Germany were very strong. Germans wanted to keep their families strong, healthy, and active. Education was revised, the woman's role was changed, and the overall Aryan racial elements were outlined in order to have a more perfect, flawless community.

Education was very important for Hitler's youth. He wanted the highest task of education to be the preservation, care, and development of the best racial elements (Pine 1). In order to do this, textbooks and schools need to be reformed. Nazi symbols were inserted into books, pictures of Hitler with children were posted in schools, and

A eventually school children were putting swastikas in their homes (Pine 2). Scientific and arithmetic examples in textbooks also helped the youth with their racial superiority education. Craniology was used to show the inferior races from the superior races (Pine 4). Arithmetic was used to show how "wasteful" the mentally challenged were and how much money could be saved by euthanasia (Pine 5). These ideas were then transferred to German homes where parents could learn about their roles in the Third Reich.

B The woman's role, in particular, was very unique. Throughout time women have tried to be treated as equals to males. Eventually they did win their rights in America, but in Nazi Germany, the woman was supposed to be "glad" to stay home and cook and clean all day long. Women were required to raise the children, cook, clean, and look after the house. They could not join in politics, nor serve in the armed forces. This was all part of the superior Aryan race and was considered to be the law.

The Aryan race was considered to be the superior human race. All others were inferior and were constantly criticized and extreme racism was used to show the Nazi's superiority. The personal characteristics of the Aryan race included honor, courage, love of freedom, and a strong spirit of scientific research (Thornton 5). Physically, the Aryans were tall, strong, and long-headed. They had blue eyes and blond hair, with a fair skin complexion (Thornton 5). Many attempts were made to increase the "pure" German blood population, such as stealing children who matched the physical requirements of the Aryan race from their homes. Himmler once responded to a question that asked "how can we be so cruel as to take a child from its mother" by saying "how much more cruel (is it) to leave a potential genius with our natural enemy," (Infield 138). Which shows how determined the Nazis were in forming a perfect German nation.

D { Breeding became a controlled issue in the Third Reich. Only the elite would reproduce (Pine 1). It became against the law for a pure-German person to breed with someone who was not. The goal was to bring together a high-grade heredity stock and to eliminate all inferior races from the German people (Moose 35). They believed that because of inferior races, like the Jews, many true German families were ruined by the result of only one "low-grade" person coming into the family. Once again, it was the Jews' fault for Germany's problems.

! { Thankfully, the Nazi regime was defeated, but most of the leaders fought it out till the end, still turning out new plans and more secret weapons. Hitler had many plans for the future, but many he would never see accomplished. He had plans for Europe, for Russia, and eventually for the whole world.

A { more PS { Hitler's main goals were to conquer Europe and form a perfect Aryan nation. A nation would be created that would thrive on National Socialism. He also wanted to conquer Russia and use the land for farming. The people would be able to live free, just as long as the Germans were their rulers. In case of a revolution, they would "drop a few bombs on their cities and the affair will be over," (Remak 128). Which shows the care, or lack there of, for the people of other nations besides Germany. Eventually, if Hitler would have won the war, the Third Reich would have spanned over the whole globe and tens of millions of more people would have been eliminated.

The Third Reich, led by Adolf Hitler, was one of the most evil and racist forms of government ever, and as a result of this, millions upon millions of people lost their lives.

CSMC { The concentration camps, the racist views, the Final Solution, and many other things were all part of Hitler's master plan of creating a perfect Aryan race to rule Germany.

Works Cited

"Histroy." Online. Available:

10/25/98.

Infield, Glenn B. Secrets of the SS. Stein and Day. Braircliff Manor, NY. 1981.

Lifton, Robert Jay. The Nazi Doctors. Robert Jay Lifton, 1986.

Moose, George L. Nazi Culture. New York: Grosset and Dunlap, 1966.

Nyomarkay. The Nazi Party. University of Minnesota, 1967.

Pine, Lisa. "Nazism in the Classroom". History Today April 1997: 22-28.

Remak, Joseph. The Nazi Years. Prentice-Hall Inc. Englewood Cliffs, NJ. 1969.

Schoenbaum, David. Hitler's Social Revolution. Doubleday Company, Inc., Garden
City, New York, 1966.

Smith, Woodruff D. The Ideological Origins of Nazi Imperialism. New York:
Oxford University Press, 1986.

Thornton, M. J. Nazism. Pergamon Press Ltd., 1966.

932-8561

Eric Harris
Period 5
Webb

How many people can a football stadium hold? Can it hold fifty, sixty thousand?

Most stadiums can. Now, picture a stadium filled, not just seats but the field and all the air above it, with dead men, women, and children. That is just a fraction of the casualties inflicted by the Third Reich. ^{Maybe more definition of who they are} The Third Reich almost completely wiped out the Jewish population in Europe. ^{May add a time period} Now in our minds, that is utterly inhumane, immoral, and evil, but in the Nazi's minds, ^{they were doing what they thought had to be done} it was perfectly fine to exterminate an entire race. Day after day

Nazi officers would casually make remarks about executions and horrors they witnessed, ^{? as an everyday joke?} just for fun. Nazism itself was hardly even a well-organized form of government.

Through the 1920s and 1930s ideas from the past and basically anything that seemed

interesting ^{to} the Adolf Hitler was added into the government policies. Nazism was a form of government not like any other in history, with very strong family values, strict ^{the paper} guidelines, educational standards, and racial beliefs.

^{maybe list your topics in your thesis of how you're writing them in} The number of deaths the Nazis are responsible ^{for} will never be known, however it ^(I thought it was 6??) is believed that from the concentration camps alone, over 11 million people lost their

lives. Add on a couple hundred thousand casualties from armies all over the world, including Germany's, and it comes out to be an amount most people today cannot even picture. The Nazis were considered evil by the ^{another word, maybe} whole world because of the death ^{majority of the world's population} they caused, the beliefs they had, and even the symbols they used in propaganda.

The Nazis had a distinct hatred ^{for} from the Jewish race. They wanted the entire race exterminated and the best, most efficient ^{accomplishing this idea was} way of ~~being this was to make~~ concentration camps. Nazi doctors ruled most of the concentration camps. Doctors like Mengele, ^{who} were considered as "...a non-human, evil force...the lord of life and death" (Lifton 345).

gas chambers and crematoriums ^{became} were responsible for most of the ^{Jews deaths} killing, but in the

Transition Sentence
this if you we listed as main subject on line. What about my quotes? hang out line??

1 As time passed,

maybe put this sentence next where marked

of concentration camps

1

earlier years, shootings were the more "popular" way of disposing of Jews. As one SS

guard once said, "the killing way easy... they just went in expecting to take showers and

instead of water we turned on poison gas." (Infield 76). Gassing was indeed the most

efficient method. ^{Many SS guards recall}... The occasional emotional difficulties encountered by the

executioners, ^{and it was a lot less emotional, for both sides.} ~~who might balk at shooting children~~, for instance, gassing proved by far the

most efficient method." (Remak 158). ~~says another SS guard.~~ The methods did vary,

Sometimes twisted Nazi officers would line up prisoners and fire a rifle round into the

first just to see how many chests it would go through. ^{Another example is that one time}

^{method that was used for} killing Jews in the city of ~~in a city called Riga, convicts, were released, given iron bars, and told to kill Jews~~

(Remak 152). The hatred was constantly reinforced through speeches from people like

Hitler and Himmler. Himmler once said "whether or not 10,000 Russian women collapse

from exhaustion while digging... ^{[what] [is]} interests me only in so far as the ditch is completed for

Germany," (History), ^{The Nazi leaders believed that everyone in Germany} which basically says that all he cares for, and all he wants everyone

needed to ~~only care for Germany.~~ ^{for the Jewish race} also in Germany to care for, is Germany. The amount of hatred ^{used} by the Nazis is

incredible, ^{The Nazis hatred was} especially for the Jewish race. "Everything the Nazis hated was" symbolized

for them by the Jews, ^{who often became} and so the Jews were often targets, scapegoats, and the usual

suspects (Thornton 10). Nazis constantly insulted the Jewish race. It helped them to

build the hatred for the Jews. Public speeches like "the Jew is... a parasite, a sponger... a

pernicious bacillus... his presence is also like that of a vampire; for whenever he

established himself [.] the people... are bound to be bled to death..." (Thornton 10) were

used to boost the hatred ^{in Germany.} also. It was all part of their beliefs. In order to maintain their

government, the Jewish race had to be forced out of the picture. "The inhuman

persecution of the Jews that the Nazis carried out was firmly based on their view of life." ^{and they saw nothing wrong w/ it.}

10 where hills up
talking about
shooting, then
go into gas
chambers

seems
next a
w
xaragraph
7 the
speeches.

maybe
talk a
few
his
about
govt. views
(communism)

on this or
try leading
into the
quote at the
beginning
to make it
flow

Seeing the killing of Jews was right.
~~and therefore, in their own minds, killing was right.~~

The Nazis were not fond of communism, either. Since communism was basically on the other side of the political spectrum from the Nazis, they wanted to get rid of communism altogether. Conquering Russia, the "heartland" of communism, would have had two ~~different~~ positive outcomes for the Nazis. One would be the end ^{of} communism, or at least that is what they thought, and the other would be that Russia would provide a large amount of living space for German farmers and workers, ~~which is what they were looking for.~~ Hitler once said that "the threat of communism... could only be dealt with ultimately by the destruction of the communist homeland, Russia," ^{which lead to} ~~and therefore, that is the reason behind Germany attacking~~ Russia. The Nazi views on the Jews and the communists were full of hate, and the concentration camps and the other methods of dealing death was all part of the Nazi policy, and a part of today's natural hatred towards Nazis.

Some people ask, "how did such an evil empire come to be?" and the answer is simple, Germany needed a leader, and Hitler was the best leader to offer. His persuasive, manipulative speeches and his promises for a great nation were basically enough to get the whole German community ^{on the same level he was on.} ~~behind him.~~ The Germans wanted something to be proud of, and Hitler ^{was able to provide it for them.} ~~gave it to them.~~ ^{with Hitler} Saying things like "the common interest before self interest," and "love Germany more than anything, and your fellow Germans more than yourself!" all helped the German people feel like they were part of something special and exciting. They were glad to see Germany being brought out of the post-World War II depression. "Germany, under the Nazi regime, was overcoming the effects of the great depression," this boosted the community's ^{moral/morality?} (Remak 75). Hitler got the Germans moving again, he gave them something to strive for. A certain energy, "... a feeling that

transition paragraph

Although Hitler was during ww2

things were moving again, that a new energy had been infused into German life," as described by one citizen, was moving through Germany (Remak 71). A new social structure was being formed, with Hitler and his ideas at the top.

transition
The Nazis used several ancient runes in their flags and military signs, along with special code words used by officers. The swastika itself, a symbol imbedded into many minds as a symbol of evil, was derived from an ancient rune called a Hakenkreuz. It was a Pagan Germanic symbol of the God of Thunder known as Donnor, or Thor (History).

Was it named that? (a certain place?)

The Nazi's "SS" symbol was also an ancient Pagan rune, known as a *sig-rune*. By itself the sig-rune was only one large lightning bolt-type "S" which symbolized victory

(History). *By putting* A badge manufacturer, *who just put* two of the sig-runes together, *the* discovered

of the "SS" symbol. *was made by* Code words, such as Aktion T4 and KZ were used often by Nazi

officers. Aktion T4 was the code name of the euthanasia program that led to the killing of approximately 100,000 lives that were "not worth living." Aktion T4 was named after

the relevant government department of the Reich chancellery located on Tiergarten

Strasse 4 in Berlin (History). KZ, which stood for *which means concentration camp* Konzentrationslager, was used

constantly by Nazi officers and soldiers, to somewhat lessen the idea of the camps, and what they were used for (History). The Third Reich was definitely a unique government, using symbols from ancient Pagan runes and coming up with entirely new and extremely racist laws.

Racism was rooted into the Nazi government just like freedom is rooted in America's government. Laws for censorship, foreigners, and duties of citizens were all warped around protecting the state. Strong censorship was imposed in Germany, against books, articles, magazines, films, and even art. Nazi rulers had complete control over

what they wanted their citizens to be seeing, hearing, and reading. They indeed "...had a free hand to determine if it could, ^[determine] every man's attitude toward life," (Moose xxi).

Euthanasia is a popular topic in today's American society, but in Nazi Germany, all mentally disabled people or people with "incurable mental defectives" were killed due to the Aktion T4 project, or more commonly known as the Euthanasia project. A citizen had strict duties, and at the top of their list was to work for the good of the state (Thornton 24). Aliens, on the other hand, were ~~to be~~ discriminated against. The German people wanted only pure German people in their country, any others were to be "disposed of." Therefore, foreigners had few rights, and Jews in particular were to be hated (Thornton 24). The concepts of racial superiority, national community, and leadership were most popular in the Nazi's *weltshauung*, or world view. Education was not made to benefit the individual, but to benefit the state. To make a more perfect generation of Germans, who were strong and prepared to sacrifice and undertake responsibilities towards the nation community (Pine 1). The security and preservation of the state and its ideals always came first; the individual was a far second.

Family values in Nazi Germany were very strong. Germans wanted to keep their families strong, healthy, and active. Education was revised, the woman's role was changed, and the overall Aryan racial elements were outlined in order to have a more perfect, flawless community.

Education was very important for Hitler's youth. He wanted the highest task of education to be the preservation, care, and development of the best racial elements (Pine 1). In order to do this, textbooks and schools need to be reformed. Nazi symbols were inserted into books, pictures of Hitler with children were posted in schools, and

type this sentence into the last page before

type conclusion into what was talked about at the end of the paper

eventually school children were putting swastikas in their homes (Pine 2). Scientific and arithmetic examples in textbooks also helped the youth with their racial superiority

education. Craniology was used to show the inferior races from the superior races (Pine

4). Arithmetic was used to show how "wasteful" the mentally challenged were and how much money could be saved by euthanasia (Pine 5). These ideas were then transferred to

German homes where parents could learn about their roles in the Third Reich.

The woman's role, in particular, was very unique. Through out time women have tried to ~~be treated as equals to~~ ^{earn an equivalent treatment as the} males. Eventually they did win their rights in America, but

in Nazi Germany, the women ^{were} supposed to be "glad" to stay home and cook and clean

all day long. Women were required to raise the children, cook, clean, and look after the

house. They could not join in politics, nor serve in the armed forces. This was all part of

the superior Aryan race and was considered to be the law.

The Aryan race was considered to be the superior human race. All others were

inferior and were constantly criticized, ~~and~~ ^{and} extreme racism was used to show the Nazi's

superiority. The personal characteristics of the Aryan race included honor, courage, love

of freedom, and a strong spirit of scientific research (Thornton 5). Physically, the Aryans

were tall, strong, and long-headed. They had blue eyes and blond hair, with a fair skin

complexion (Thornton 5). Many attempts were made to increase the "pure" German

blood population, such as stealing children who matched the physical requirements of the

Aryan race from their homes. Himmler once responded to a question that asked "how

can we be so cruel as to take a child from its mother" by saying "how much more cruel

[(is it)] to leave a potential genius with our natural enemy" (Infield 138). ~~Which shows~~

how determined ^{very determined} the Nazis were in forming a perfect German nation.

move up 1 sentence
b/c you are talking
about it there

any
quotes to
support this?

transition

maybe
expand

maybe include this with the last IP when you talked about the 100ks: Purity

Breeding became a controlled issue in the Third Reich. Only the elite would reproduce (Pine 1). It became against the law for a pure-German person to breed with someone who was not. The goal was to bring together a high-grade heredity stock and to eliminate all inferior races from the German people (Moose 35). They believed that because of inferior races, like the Jews, many true German families were ruined by the result of only one "low-grade" person coming into the family. Once again, it was the Jews' fault for Germany's problems.

reclusion
at main
topic

Thankfully, the Nazi regime was defeated, but most of the leaders fought it out till the end, still turning out new plans and more secret weapons. Hitler had many plans for the future, ^{that} but many he would never see accomplished. He had plans for Europe, for Russia, and eventually for the whole world.

expand

Hitler's main goals were to conquer Europe and form a perfect Aryan nation. A nation would be created ^{to} that would thrive on National Socialism. He also wanted to conquer Russia and use the land for farming. The people would be able to live free, just as long as the Germans were their rulers. In case of a revolution, they would "drop a few bombs on their cities and the affair will be over," (Remak 128). ^{Those types of events} which shows the care, or lack there of, for the people of other nations besides Germany. Eventually, if Hitler would have won the war, the Third Reich would have spanned over the whole globe and tens of millions of more people would have been eliminated.

The Third Reich, led by Adolf Hitler, was one of the most evil and racist forms of government ever, and as a result of this, millions upon millions of people lost their lives. The concentration camps, the racist views, the Final Solution, and many other ^{tiny plans} things were all part of Hitler's master plan of creating a perfect Aryan race to rule Germany.

Works Cited

"Histroy." Online. Available:

10/25/98.

Infield, Glenn B. Secrets of the SS. Stein and Day. Braircliff Manor, NY. 1981.

Lifton, Robert Jay. The Nazi Doctors. Robert Jay Lifton, 1986.

Moose, George L. Nazi Culture. New York: Grosset and Dunlap, 1966.

Nyomarkay. The Nazi Party. University of Minnesota, 1967.

Pine, Lisa. "Nazism in the Classroom". History Today April 1997: 22-28.

Remak, Joseph. The Nazi Years. Prentice-Hall Inc. Englewood Cliffs, NJ. 1969.

Schoenbaum, David. Hitler's Social Revolution. Doubleday Company, Inc., Garden
City, New York, 1966.

Smith, Woodruff D. The Ideological Origins of Nazi Imperialism. New York:
Oxford University Press, 1986.

Thornton, M. J. Nazism. Pergamon Press Ltd., 1966.

Eric Harris
12/10/97

Guns in School

I. In the past few weeks there has been news of several shootings in high schools. A student in Texas killed three fellow classmates and injured many more when he fired at a prayer group before school. This student had several other weapons with him when he was apprehended, showing how easy it was to bring so many weapons to school and not be noticed. Students who bring guns to school are hardly ever detected. ^{(This} ~~Which~~ is shocking to most parents and even other students since it is ^{just} as easy to bring a loaded handgun to school ^{as} than it is to bring a calculator. ⁾ The problem of guns in school is a major one faced by many parents, teachers, and citizens these days. Solutions are hard to come by in such a situation because of how widespread the problem is and how different each school in each town can be. Students can get weapons into school too easily and they have too much access to weapons outside of school.

A. Weapons in school are hard to detect and students have ways of getting out of searches or other ways of detection.

1. A 1990 survey conducted by the Centers For Disease Control (CDC) found

that one in 20 high school students carried a gun in the past month (CDC) ^{which shows that guns are in schools too often}

2. Students can use their backpacks, purses, or even projects to bring weapons into school.

3. Metal detectors can be avoided by using other school entrances.

B. Students have access to many weapons and can get a hold of a gun from many places.

1. Their (junk guns) low price ^{the low price of junk guns,} (as low as 69 dollars) ^{can} also bring these guns within the economic reach of children (Gun Digest, 288).

???

2. School security experts and law enforcement officials estimate that 80% of the firearms students bring to school come from home, while students estimate that 40% of their peers who bring guns to school buy them on the street (Harrington 22).

3. "Junk Guns," also known as Saturday Night Specials, are handguns that are extremely small, inexpensive and typically poorly made (Junk Guns).

One article from the Internet shows that

a. Implying that these "junk guns" can be found and purchased easily by students.

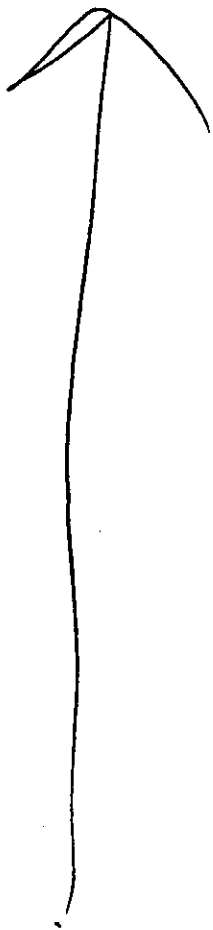



~~Guns in School: Solution~~

~~Eric Harris
12/10/97~~

Guns in schools are a growing problem in today's society. Every day the news broadcasts stories of students shooting students, or going on killing sprees, or even just bringing a gun to school. Students bring guns to school for many reasons. Some for protection, some for attacking, and even some to show off. However, a school is no place for a gun. Solutions for this problem are hard to come by and often ^{too} expensive for most schools to even consider, ^{however} Metal detectors and more police officers are two very good solutions, ~~though~~.

Metal detectors posted at entrances in schools can prevent guns from entering schools. That is a given fact. Although, the cost of these machines are rather high and some schools simply can not afford them. Tax payers and donations are other ways to form money to buy detectors, but some tax payers would not be happy with the prices. Several schools in the United States have metal detectors, and shootings still take place in the school. Students can be very resourceful, and can find ways to avoid the detectors. The idea of more police officers is a very good solution. However, this would also cost more money for the tax payers. The end result, in my opinion, is worth every penny spent.

Police officers can discourage students from bringing weapons and can stop anyone who manages to get a weapon in the school. They are there to protect and serve, so students can go to them if they want to report someone with a gun or any other incident. More cops in schools is a great start to preventing more shootings in schools. On the other hand, the more cops in a school the more it begins to look like a prison. The community does not want it's schools looking like jail houses with the children as the prisoners. They are there to learn, and if students feel uncomfortable, that only leads to more problems. Drop-outs, grades, and student moral would all

get worse with the presence of police, Even though the cops are there for the students safety. Therefor, only a few cops should be assigned to schools at first. Let them get familiar with the students and let the students get to know the officers. This will help the moral of the student body.

Metal detectors and other forms of detectors are very good solutions. Once installed in all main entrances, students can simply walk through while trained officers can search suspicious bags and backpacks if the alarm goes off. Students will be much more safe, but the fact of low moral is still present. One problem with metal detectors is that several school-related items are metal and would most likely set off the alarm. This leads to several searches that turn up nothing. This can cause long lines and be a hassle for students.

More and more we hear of shooting sprees and rampages on the news. Some can be prevented, some can not. Almost any school shooting could have been prevented in some way or another, we just have to spend the necessary time and money to figure out how. Metal detectors and more police officers are only two good solutions. If tax payers can afford to do one or both of these solutions, then that is fantastic. If not, then the community needs to figure out other ways to keep guns out of schools. Students can not learn very well and be motivated if they know that someone in their classroom has a gun with them. In conclusion, metal detectors and more police officers are a great start to the fight against guns in school.

Eric Harris
12/10/97

Work cited

Centers For Disease Control. "Weapon Carrying Among High School Students." Morbidity and Mortality Weekly Report. Vol. 40 No. 40. 11 Oct. 1991.

Gun Digest 1995, 49th Annual Edition. Northbrook, IL, DBI Books, Inc., 1994. 288.

Harrington, Donna. "Blown Away." The American School Board Journal. May, 1992. 22.

"Junk Guns." On-line. Available: http://www.gunfree.org/csgv/bsc_jun.htm. 9 Dec. 1997.

932-8561

Eric Harris
Period 5
Webb

How many people can a football stadium hold? Can it hold fifty, sixty thousand?

Most stadiums can. Now, picture a stadium filled, not just seats but the field and all the air above it, with dead men, women, and children. That is just a fraction of the casualties inflicted by the Third Reich. The Third Reich almost completely wiped out the Jewish population in Europe. Now in our minds, that is utterly inhumane, immoral, and evil, but in the Nazi's minds, it was perfectly fine to exterminate an entire race. Day after day Nazi officers would casually make remarks about executions and horrors they witnessed, just for fun. Nazism itself was hardly even a well-organized form of government. Unclear.

Through the 1920s and 1930s ideas from the past and basically anything that seemed interesting the Adolf Hitler was added into the government policies. Nazism was a form of government not like any other in history, with very strong family values, strict guidelines, educational standards, and racial beliefs.

The number of deaths the Nazis are responsible will never be known, however it is believed that from the concentration camps alone, over ^{write out} 11 million people lost their lives. Add on a couple hundred thousand casualties from armies all over the world, including Germany's, and it comes out to be an amount most people today cannot even picture. The Nazis were considered evil by the whole world, because of the death they caused, the beliefs they had, and even the symbols they used in propaganda.

The Nazis had a distinct hatred from the Jewish race. They wanted the entire race exterminated and the best, most efficient way of doing this was to make concentration camps. Nazi doctors ruled most of the concentration camps. Doctors like Mengele, who were considered as "... a non-human, evil force... the lord of life and death" (Lifton 345). Gas chambers and crematoriums were responsible for most of the killing, but in the

What is the Third Reich?

earlier years, shootings were the more "popular" way of disposing of Jews. As one SS guard once said, "the killing way easy... they just went in expecting to take showers and instead of water we turned on poison gas" (Infield 76). Gassing was indeed the most

efficient method. "... The occasional emotional difficulties encountered by the executioners, who might balk at shooting children, for instance, gassing proved by far the most efficient method," (Remak 158) says another SS guard. The methods did vary,

sometimes twisted Nazi officers would line up prisoners and fire a rifle round into the first just to see how many chests it would go through. Another example is that one time in a city called Riga; convicts were released, given iron bars, and told to kill Jews

(Remak 152). The hatred was constantly reinforced through speeches from people like Hitler and Himmler. Himmler once said "whether or not 10,000 Russian women collapse from exhaustion while digging... interests me only in so far as the ditch is completed for

Germany," (History) which basically says that all he cares for, and all he wants everyone else in Germany to care for, is Germany. The amount of hatred by the Nazis is incredible, especially for the Jewish race. "Everything the Nazis hated was symbolized

for them by the Jews," and so the Jews were often targets, scapegoats, and the usual suspects (Thornton 10). Nazis constantly insulted the Jewish race. It helped them to build the hatred for the Jews. Public speeches like "the Jew is... a parasite, a sponger... a

pernicious bacillus... his presence is also like that of a vampire; for whenever he established himself (X) the people... are bound to be bled to death..." (Thornton 10) were used to boost the hatred also. It was all part of their beliefs. In order to maintain their

government the Jewish race had to be forced out of the picture. "The inhuman persecution of the Jews that the Nazis carried out was firmly based on their view of life,"

is quote
right make
complete
inference.

History ")?

also

cite source?

^{sp?}
and therefor, in their own minds, killing was right. The Nazis were not fond of communism either. Since communism was basically on the other side of the political spectrum from the Nazis, they wanted to get rid of communism altogether. Conquering Russia, the "heartland" of communism, would have had two different positive outcomes for the Nazis. One would be the end of communism, or at least that is what they thought, and the other would be that Russia would provide a large amount of living space for German farmers and workers, which is what they were looking for. Hitler once said that "the threat of communism... could only be dealt with ultimately by the destruction of the communist homeland, Russia," and therefor that is the reason behind Germany attacking ^{sp?} Russia. ^{awk.} The Nazi views on the Jews and the communists were full of hate, and the concentration camps and the other methods of dealing death was all part of the Nazi policy, and a part of today's natural hatred towards Nazis.

Some people ask, "how did such an evil empire come to be?" and the answer is simple, Germany needed a leader, and Hitler was the best leader ^{Germany had} to offer. His persuasive, manipulative speeches and his promises for a great nation were ~~basically~~ enough to get the whole German community behind him. The Germans wanted something to be proud of, and Hitler gave it to them. Saying things like "the common interest before self interest," and "love Germany more than anything, and your fellow Germans more than yourself!" all helped the German people feel like they were part of something special and exciting. They were glad to see Germany being brought out of the post-World War II depression. "Germany, under the Nazi regime, was overcoming the effects of the great depression," ^{source?} This boosted the community's moral (Remak 75) Hitler got the Germans moving again, he gave them something to strive for. A certain energy, "... a feeling that

things were moving again, that a new energy had been infused into German life," as described by one citizen, was moving through Germany (Remak 71). A new social structure was being formed, with Hitler and his ideas at the top.

The Nazis used several ancient runes in their flags and military signs, along with special code words used by officers. The swastika itself, a symbol imbedded into many minds as a symbol of evil, was derived from an ancient rune called a *Hakenkreuz*. It was a Pagan Germanic symbol of the God of Thunder known as Donnor, or Thor (History). The Nazi's "SS" symbol was also an ancient Pagan rune, known as a *sig-rune*. By itself the sig-rune was only one large lightning bolt-type "S" which symbolized victory (History). A badge manufacturer, who just put two of the *sig-runes* together, discovered the "SS" symbol. Code words, such as Aktion T4 and KZ were used often by Nazi officers. Aktion T4 was the code name of the euthanasia program that led to the killing of approximately 100,000 lives that were "not worth living." Aktion T4 was named after the relevant government department of the Reich chancellery located on Tiergarten Strasse 4 in Berlin (History). KZ, which stood for Konzentrationslager, was used constantly by Nazi officers and soldiers, to somewhat lessen the idea of the camps, and what they were used for (History). The Third Reich was definitely a unique government, using symbols from ancient Pagan runes and coming up with entirely new and extremely racist laws.

Racism was rooted into the Nazi government just like freedom is rooted in America's government. Laws for censorship, foreigners, and duties of citizens were all warped around protecting the state. Strong censorship was imposed in Germany, against books, articles, magazines, films, and even art. Nazi rulers had complete control over

what they wanted their citizens to be seeing, hearing, and reading. They indeed "... had a free hand to determine if it could, every man's attitude toward life," (Moose xxi).

[,]
Euthanasia is a popular topic in today's American society, but in Nazi Germany, all mentally disabled people or people with "incurable mental defectives" were killed due to the Aktion T4 project, ~~is~~ more commonly known as the Euthanasia project. A citizen had strict duties, and at the top of their list was to work for the good of the state (Thornton 24). Aliens, on the other hand, were to be discriminated against. The German people wanted only pure German people in their country, any others were to be "disposed of." ^{SP?} Therefore, foreigners had few rights, and Jews in particular were to be hated (Thornton 24). The concepts of racial superiority, national community, and leadership were most popular in the Nazi's *weltshauung*, or world view. Education was not made to

benefit the individual, but to benefit the state; ^{to} ~~to~~ make a more perfect generation of Germans, who were strong and prepared to sacrifice and undertake responsibilities towards the nation community (Pine 1). The security and preservation of the state and its ideals always came first; the individual was a far second.

Family values in Nazi Germany were very strong. Germans wanted to keep their families strong, healthy, and active. Education was revised, the woman's role was ~~changed~~, and the overall Aryan racial elements were outlined in order to have a more perfect, flawless community.

Education was very important for Hitler's youth. He wanted the highest task of education to be the preservation, care, and development of the best racial elements (Pine 1). In order to do this, textbooks and schools need to be reformed. Nazi symbols were inserted into books, pictures of Hitler with children were posted in schools, and

Not complete
Smb. Try:

eventually school children were putting swastikas in their homes (Pine 2). Scientific and arithmetic examples in textbooks also helped the youth with their racial superiority education. Craniology ^{define} was used to show the inferior races from the superior races (Pine 4). Arithmetic was used to show how "wasteful" the mentally challenged were and how much money could be saved by euthanasia (Pine 5). These ideas were then transferred to German homes where parents could learn ^{about} ~~about~~ their roles in the Third Reich.

The woman's role, in particular, was very unique. Through out time women have tried to be treated as equals to males. Eventually they did win their rights in America, but in Nazi Germany, the woman was supposed to be "glad" to stay home and cook and clean all day long. Women were required to raise the children, cook, clean, and look after the house. They could not join in politics, nor serve in the armed forces. This was all part of the superior Aryan race and was considered to be the law.

The Aryan race was considered to be the superior human race. All others were inferior and were constantly criticized and extreme racism was used to show the Nazi's superiority. The personal characteristics of the Aryan race included honor, courage, love of freedom, and a strong spirit of scientific research (Thornton 5). Physically, the Aryans were tall, strong, and long-headed. They had blue eyes and blond hair, with a fair skin complexion (Thornton 5). Many attempts were made to increase the "pure" German blood population, such as stealing children who matched the physical requirements of the Aryan race from their homes. Himmler once responded to a question that asked "how can we be so cruel as to take a child from its mother ⁽²⁾ by saying "how much more cruel (is it) to leave a potential genius with our natural enemy," (Infield 138) ^{which} ~~shows~~ ^{or. This} how determined the Nazis were in forming a perfect German nation.

what is that?

Breeding became a controlled issue in the Third Reich. Only the elite would reproduce (Pine 1). It became against the law for a pure-German person to breed with someone who was not. The goal was to bring together a high-grade heredity stock and to eliminate all inferior races from the German people (Moose 35). They believed that because of inferior races, like the Jews, many true German families were ruined by the result of only one "low-grade" person coming into the family. Once again, it was the Jews' fault for Germany's problems.

Thankfully, the Nazi regime was defeated, but most of the leaders fought it out ~~till~~ ^{until} the end, still turning out new plans and more secret weapons. Hitler had many plans for the future, but many he would never see accomplished. He had plans for Europe, for Russia, and eventually for the whole world.

Hitler's main goals were to conquer Europe and form a perfect Aryan nation. A nation would be created that would thrive on National Socialism. He also wanted to conquer Russia and use the land for farming. The people would be able to live free, just as long as the Germans were their rulers. In case of a revolution, they would "drop a few bombs on their cities and the affair will be over" (Remak 128). Which shows the care, or lack there of, for the people of other nations besides Germany. Eventually, if Hitler would have won the war, the Third Reich would have spanned over the whole globe and tens of millions of more people would have been eliminated.

The Third Reich, led by Adolf Hitler, was one of the most evil and racist forms of government ever, and as a result of this, millions upon millions of people lost their lives. The concentration camps, the racist views, the Final Solution, and many other things were all part of Hitler's master plan of creating a perfect Aryan race to rule Germany.

Works Cited

"Histroy." Online. Available: 7

~~10/25/98~~ 25 October 1998.

- Infield, Glenn B. Secrets of the SS. Stein and Day. Braircliff Manor, NY. 1981.
- Lifton, Robert Jay. The Nazi Doctors. Robert Jay Lifton, 1986.
- Moose, George L. Nazi Culture. New York: Grosset and Dunlap, 1966.
- Nyomarkay. The Nazi Party. University of Minnesota, 1967.
- Pine, Lisa. "Nazism in the Classroom". History Today April 1997: 22-28.
- Remak, Joseph. The Nazi Years. Prentice-Hall Inc. Englewood Cliffs, NJ. 1969.
- Schoenbaum, David. Hitler's Social Revolution. Doubleday Company, Inc., Garden City, New York, 1966.
- Smith, Woodruff D. The Ideological Origins of Nazi Imperialism. New York: Oxford University Press, 1986.
- Thornton, M. J. Nazism. Pergamon Press Ltd., 1966.

The battered marine sat against the wall of the personnel carrier as we drove back

to the base. We had picked him up from the battle scene an hour ago, and my first thought was of how tired he must be. Every bump the carrier went over he jumped awake at full attention, ready for anything. Apparently he ^{had had} did not get much sleep during the days of fighting. I noticed his ^{armor} armor as he took it off earlier, it had scratches and

holes in it. Blackened burn marks speckled the chest plate and a long greenish cut ran along the back plates. His ^{shin} shin guards had horizontal cuts embedded into them and one of his shoulder pads was torn in half. Amazingly his body only suffered minor wounds.

It was amazing that he was still alive on account that his helmet was chipped and dented in several different places. His body was almost mumbling, "Thank God" or "Kevlar" as he sat sleeping. His clothes were shredded and the steel toes in his boots were almost falling out. His strong arms had bandages all over them and his gloves had been worn through

across the knuckles and the lower thumb. He had mumbled something about "around ten-thousand rounds" as the dim-witted lieutenant asked him how many rounds he had fired during an attempted de-briefing. ^{His} His shotgun lay beside him, ^{and} his pulse rifle on

the other side, both were still warm from repeated usage earlier. His standard-issue pistol was holstered, but apparently he had used and lost all five of his clips. There were a few splashes of dried blood on his body, most of it was not his own though. Signs of quite a

few close-encounters that turned ugly. I noticed something odd when we tugged him aboard. His left pocket made a jingling sound whenever he moved, which I later realized was filled with dog-tags that he collected from his fallen platoon. As he pulled them out to give to the lieutenant, I saw that one was ripped in half, and another had a rather large hole in the center of it. After emptying his pockets he started describing some of his

Good You establish interest from the start

no

good use of details

tighten for variety

you might have done this earlier.

no

P



NEAT SHEET®
perforated pages

80 SHEETS
COLLEGE RULED
10½x 8in / 26.6 x 20.3cm
1 SUBJECT *wireless*
NEATBOOK® NOTEBOOK



JC-001-026164



Eric
Harris

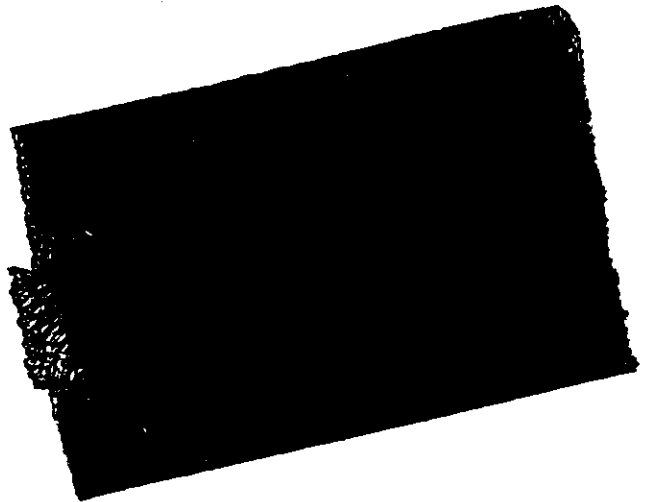

Marine/hunter

Proud, somber, elder, battle worn

Boat knife - worn but sharp

Riot gun - used alot

Double barrel shotgun

Super rocket launcher

Alien head trophy

Ogre head trophy

mortar shell

bed w/ metal frame ~~was~~

oak desk - carved, burnt,

KMFDM Poster

-Black

jade incense, gun grease

smooth red dark wood

like a veteran from ancient wars

drone

respect, earned it, has pride in his work.

Medal of Honor

Iron cross 1st class

Butane torch

mini Forge

Super computer - dirty, worn

21 inch monitor -

Fog machine

Strobe light

Black light

box of cubans - half gone

laser system

I was told to find an old marine veteran because of some government project he was needed for. After searching for a few hours I just waited for him to come home in his room. The room was large, as opposed to the barracks I am used to. It had a high ceiling, probably about 13 feet with metal rectangular beams going across it at about 12 feet high. The walls were all somewhat dark, with a metallic, yet wooden, texture to them. The floor was smooth, and it had a dark forest green color to it. The bed was in the corner of the room, ~~was~~ and it looked like top quality oak wood to me, and the

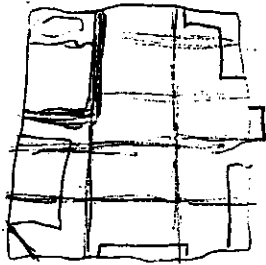

matress was just begging for someone to sleep on it. A large stainless steel work table was next to the foot of the bed. It was definitely used quite often. Having cuts, burns, and rounded edges gave me the feeling this soldier uses it a lot. The corner in that part of the room was blocked by a diagonal door marked with a biohazard and a skull & crossbones sign. I didn't even dare look into that closet. There also seemed to be some kind of a door behind the work table, almost like a garage door, or a door like a cafeteria store uses. Across the room stood a rather large trophy case. On it were several items in which I have never seen before, such as oddly shaped skulls and claws. Included on the shelves were old worn down books, along with a few gothic, mystical treasures. This marine has definitely traveled in some very exotic theaters. On an adjacent wall were several mounted weapons that have seen more combat than I will in my life. To name a few; mini chaingun, riotgun, AB-10, beefed up rocket launcher, and a cutdown duck gun. A virtual arsenal of high grade military weaponry. On the wall opposite of the gun displays were several old posters. One looked like a World War II nazi propaganda poster, except it read KMFDM on the top of it. Another had a pure american bald eagle, another said God-like. Under the posters was a super fast computer with DOOM sketched across the top of the monitor. A nice black leather chair was sitting, as if on guard, by the computer table. Next to the computer was the entrance to the room itself, and where normal light switches

are placed was a panel of knobs and switches, apparently, the lighting in the room could be normal, blacklight, strobed, red, or "full-moon". After another 20 minutes of waiting for this soldier I finally left, only to run into him outside. I gave him the papers and said he had a helluva room, to which he replied simply, "thanks."

gigantic warhead and with a blitzkrieg of monsters in the small doorway between the windows, the marines couldn't ward off the invaders. Arms, legs, and heads were tossed about, some burnt off, some torn. It was a slaughter. Even though the mass of alien bodies nearly quadrupled the number of marines, they still didn't have a chance. Spent shells and cartridges ~~scattered~~ sprinkled the blood soaked floor. It must be crazy to fight against whatever was waiting ahead, but after seeing an entire city full of death and chaos, who wouldn't be a little out of their mind?

This female, who I will call Petsy, is a sad woman. She spends all of her time in front of a mirror putting makeup on. She seems like a slutty trendy bitch who people like to look because she seems pretty by social standards. She feels very dense, she just smiles and says "gosh, ok!" in a cheerful but dumb manner. She just wants to be liked. She doesn't know she is different, she thinks she is normal and not different. Dense, stupid, shallow, dazed.

She feels happy yet she doesn't know what to do.

She is covered with party-tan makeup and golden hair. She smells of cheap perfume and hairspray. I hear wind... of the ocean... when looking at her. She remembers that she has an audition coming up for a cheap B movie where she thinks she will be acting.

She feels smooth but cold. The taste of polyester comes to mind.

~~The line I choose is when Owen says "You let me die"~~
actually, scratch that. I choose the line when Johnny's
baseball coach says "You want the fucking baseball?"
he shows power and control in this scene. Johnny's
mom was killed and the cop was acting dumb
so he needed to take charge.

1 The forest-green field was hot under the sun.

2 The game was in it's 2nd overtime.

3 5 soccer balls were already destroyed from heavy hits.

4 Injured players were being treated on the side line.

5 ~~Orders~~ ^{that were} being yelled by coaches and players

6 Confused us all.

7 Time was running low, as was our energy.

8 The ball must go through the enemy lines.

9 Over head we saw planes flying by.

10 All in our direction, seeming to give us more power.

11 Their defense was strong.

12 None of our attacks could punch through.

13 We tried several different kinds of attacks,

14 Through pure luck, as always, we made it through.

15 The defenses were smashed and we punched through to the goal!

16 As we celebrated our victory, we felt sorry for the other team.

17 But that was just to bad for them.

stupid fucking saxophone crap I hate this kinda fuckin' music. God damn white bushy apes and spear chucks snappin their gay little fingers and tapping their faggot little shoes. I want to take that sax and toss it into a vat of molten steel along with it's owner. or maybe charge into their gay little night club blasting away with an AR-15 and kill everyone of those punkeass happy jazzy fucksticks.

Oh jesus this is even worse than the last piece. This is what passes for music these days? ^{Buddah} ~~Jesus~~, el could go get a music contract. What catagory is this BS anyway? Shell blowing - bone wacking Tree shaking, jazz? I really dont want to hear about some annoying middleaged loser whining about his stupid stream of consciousness tappe lyrics. Next they will throw in some frogs croaching or charisaurus roaring.

Hmm, a bit calmer so far. no jungle bunnies running around banging on things. Is this a fast pace song for the Earth spirit club maybe? Thank God there aren't any lyrics I find that lyrics can often ruin good music. Well this isn't so bad, kind of trancey. Quick too, wats that a dog. Oh goodie, el hear space invaders now. Damn it, more random crap.

Jesus now its ruined. stupid symbols or whatever they are called. must be hard to carry THAT beat. OK now stop screwin with it.

Oh yip-ee. Enya wannobes with a twist of 80s synthesizer in it. Now we're a jammmin dude. Ug I need some KMFDM. Is this the soundtrack to a little fantasy movie about a boy and his star ship cruiser? Sounds like something aerobics classes dance to when ~~so~~ they forget their CDs. Hmm, for some reason I feel like flying through a city with the spice girls.

Ug. This is undescrivable. I feel like I'm walking around in a frigg'n cartoon for God's sake. Bloody bounito boys and their little banjo barakas. What the fuck is this! Screw you guys, I'm going to lunch, and listening to good fucking music.

This
Y I
X G S

THIS A
I S - W
DIPUT S

DOUMBHIS
S C I S U M

S H
P U T

CHT New B e
R Te' u q

GUN

I'm gonna spit a hell of a lot of buckshot out my barrel into this pansy's face.

Black.

I can't see a God damn thing so what the hell am I gonna write about, how I can't see anything? My mind is black, sight is black, hearing is black, everything, so HA.

Shotgun shell

red

gold

smooth

thick

heavy

cool

circular

polished

canvased

loud

deadly

steady

reliable

explosive

solid

military-like

dark,

cold

strong

solid

metallic

smooth

mechanic

crowded

greasy

stacked on top of others of its kind

-Water, it destroys the potentiality of it,

it will be wasted, it will be useless

it loves being ~~loaded~~ loaded, it hates waiting.

Hicks Vasquez Taggart

JC-001-026175

Hicks V. Taggart

Age 1 week.
family OO buck. #7-9 buckshot, slugs.
wish to kill.
fear water
location Boy w/ its brothers.
sig. other shotgun.

I was trying to be loaded into the shotgun when I got jammed in the chamber. The shotgun thought I was all the way in, and tried to fire. IT was too smart for itself because it had a safety mechanism that prevented it from firing.

I was pissed that he neglected to notice me being stuck and tried to fire. Oh well, those things happen. He eventually had me cleared and reloaded. I still have scratches on my brass from the damn chamber, so a grudge has remained between me and Arlene.

earliest memory is hard to visualize, I might not be even true. My mind tends to blend memories together. I do remember the 4th of July when I was 12. I remember riding my bike down a street. I hid in a closet. I hid from everyone when I wanted to be alone. I remember running outside with a lot of other kids and it felt like an invasion. A bonfire in a clearing in a private property area. Firework smells.

██████████ I wanted to chain his hyper ass down.
I think I had a buggy cut and was real stinky.
Shit holes

NO FEAR POGS Green day walked burnt stuff.

my room. movie tickets, butter caselings.

6th grade School Bus.

Riding home every day sitting in the back seats with [redacted], [redacted], [redacted] and others. Talking about guns, sex, and people. [redacted] standing up for his mom saying do mamma likes to others. [redacted] being goofy taking about his girlfriends [redacted] being real quiet with his big brown eyes. our ~~refuge~~ refuge from everyone else. where we talked about personal things

The document described below
has been removed

Description of Document: Anarchist's
Cookbook, Bomb-making Instructions

Date of Document: N/A

Reason for Removal

- Copyright
- Bomb-making instructions
- Medical Records
- Other

Comments: _____



Pep Boys #243
 5134 South Wadsworth
 Littleton, CO 80123
 (303) 932-0606

PEP BOYS # 243
 5134 S. WADSWORTH BLVD.
 LAKEWOOD, CO 80123 (303)-932-0606

Reg 1 Trx 254339
 Cashier 18 3/15/98 11:47:45

1 #03099914813	34.99 T
REMAN. MASTER CYL.	
CORE	6.00 T
#03099914813	6.00-T
REMAN. MASTER CYL.	
CORE ALLOWANCE	
1 #07933101065	1.39 T
TAPE REPAIR:CARDED W/DISPE	
1 #07633312083	8.49 T
FILTER AIR 4:PUROLATOR	
1 #07934012020	3.49 T
/REPAIR GASTNK:INSTANT GAS	
Sub-total	48.36
Tax	3.29
Total	51.65
** CASH PAYMENT **	52.00
Change	.35

*** Thank You ***
 RECEIPT REQUIRED FOR RETURNS

REG #1 TRX #39742
 CASHIER #9920 12/27/98 14:09

1 AIR TOOL	34.99 T
0-39564-50563	
1-AIR TOOL	34.99-T
0-39564-50563	
VOID	
1-PROSTOP BRAKE PADS	12.99-T
0-30999-07301	
RETURN Resell	
1-PROSTOP S/M PAD	13.99-T
0-30999-09138	
RETURN Resell	
0 Items	Subtotal 26.98-
	Tax 1.84-
	Total 28.82-
*** CASH REFUND ***	28.82
Cash Change	28.82

*** RETURN SALE ***

RETURN AMOUNT: 28.82
 CORE RETURN AMOUNT: .00

Angelo's CD's & Tapes
40 W. LITTLETON BLVD #202
LITTLETON, CO 80120
303-798-6378

02/15/99 *** Sales Receipt *** 15:56
Register: 010 Ticket # 72140
Salesman: 94 Customer: 1
INHOUSE ACCOUNT,

Part Number	Price	Qty.	Amount
MEP122	14.99	1	14.99
LIGHTS OF EU VOICES		CD N	

Sub Total: 14.99 Sales Tax: 1.02
Total Sale Amount: \$16.01
T.S. #654 at \$4.00
Tender Cash: 20.01
Change: 8.00

absolutely no cash refunds!!!
no returns on body jewelry!!!
thank you...please come again!

Angelo's CD's & Tapes
40 W. LITTLETON BLVD #202
LITTLETON, CO 80120
303-798-6378

03/08/99 *** Sales Receipt *** 14:52
Register: 009 Ticket # 74809
Salesman: 94 Customer: 1
INHOUSE ACCOUNT,

Part Number	Price	Qty.	Amount
CLE7269	13.99	1	13.99
ELECTRIC HEL BURN BABY BU		CD N	
MEP98	16.99	1	16.99
FUNKER VOGT KILLING TIME		CD N	

Sub Total: 30.98 Sales Tax: 2.11
Total Sale Amount: \$33.09
Tender Cash: 100.00
Change: 66.91

absolutely no cash refunds!!!
no returns on body jewelry!!!
thank you...please come again!

AutoZone 972-8601

#697622 38-18 18" WINTER BLA 5.99 P
#587622 38-18 18" WINTER BLA 5.99 P
SUBTOTAL 11.98
SALES TAX1 .52
TOTAL 12.50
CASH 28.00
CHANGE 7.50

KEEP THIS RECEIPT

Our Best Price Every Day
7 #032048 12/23/98 13:32 CSR #18
REG #01 STORE #0837 STR. TRANS #134364

MEDIA PLAY #8132
BOWLES CROSSING CENTER LITTLETON, CO
PHONE 303-933-7510

8132 00014 31253 12/08/98
SALE 860 01:52 PM

05730569 MCKENNITT L/MASK-KIS
DEPT #12 14.99
14.99 TAX 4.800% 0.72
TOTAL \$15.71
CASH 20.00
CHANGE -4.29

GIFT CERTIFICATES ARE THE PERFECT GIFT
FOR EVERYONE THIS HOLIDAY SEASON!!

MEDIA PLAY #8132
BOWLES CROSSING CENTER LITTLETON, CO
PHONE 303-933-7510

8132 00005 45749 12/26/98
SALE 497 02:02 PM

08640732 VAR/INDUSTRIAL WAR 14.99
DEPT #12
08773368 VAR/INDUSTRIAL ROCK 16.99
DEPT #12
06288278 LEATHER STRIP/SERENA 13.99
DEPT #12

45.97
61900611
SUBTOTAL 45.97
TAX 4.800% 2.21
TOTAL \$48.18
MCERT ROM 28.28
CASH 100.00
CHANGE -80.10

RING IN THE NEW YEAR AT MEDIA PLAY!!
PICK UP THE HOTTEST SELLING MUSIC, TODAY

MEDIA PLAY #8132

BOWLES CROSSING CENTER LITTLETON, CO
PHONE 303-933-7510

8132 00014 61318 12/17/98
SALE 332 09:55 PM

08981680 WILLIAMS V/NEXT 14.99
DEPT #12
14.99 TAX 4.800% 0.72
TOTAL \$15.71
CASH 16.00
CHANGE -0.29

GIFT CERTIFICATES ARE THE PERFECT GIFT
FOR EVERYONE THIS HOLIDAY SEASON!!

Angelo's CD's & Tapes
40 W. LITTLETON BLVD #202
LITTLETON, CO 80120
303-798-6378

01/18/99 *** Sales Receipt *** 14:50
Register: 011 Ticket # 68660
Salesman: 77 Customer: 1
INHOUSE ACCOUNT,

Part Number	Price	Qty.	Amount
CLE9578	9.99	1	9.99
DIE KRUPPS	FATHERLAND	CD N	
CLE5185	13.99	1	13.99
NOSFERATU	RISE	CD N	
TSHRT1005	13.99	1	13.99
HATS MISC	HATS MISC	TS N	
discount	4.00 = 22.23 %		

Sub Total: 37.97 Sales Tax: 2.58
Total Sale Amount: \$40.55
T.S. #616 at \$11.00
Tender Cash: 40.00
Change: 10.45

Total Discount: 4.00

absolutely no cash refunds!!!
no returns on body jewelry!!!
thank you...please come again!

Angelo's CD's & Tapes
40 W. LITTLETON BLVD #202
LITTLETON, CO 80120
303-798-6378

12/22/98 *** Sales Receipt *** 17:05
Register: 011 Ticket # 64503
Salesman: 90 Customer: 1
INHOUSE ACCOUNT,

Part Number	Price	Qty.	Amount
TVB760	12.99	1	12.99
KMFDM	AGOGO	CD N	
SNY52406	14.99	1	14.99
FRONT 242	FRONT BY FRO	CD N	

Sub Total: 27.98 Sales Tax: 1.90
Total Sale Amount: \$29.88
Tender Cash: 30.00
Change: 0.12

absolutely no cash refunds!!!
no returns on body jewelry!!!
thank you...please come again!

MEDIA PLAY #8132
 BOWLER CROSSING CENTER LITTLETON CO
 PHONE 303-751-0110
 DATE: 08/15/98
 SALE: 141 02:24 PM
 09970779 RAMMSTEIN YOU REMIND
 DEPT: 111
 SALES TAX: 1.01
 TOTAL: 27.75
 CASH: 28.00
 CHANGE: 0.25
 DISNEY'S LAY AND THE TRAMP IS NOW
 AVAILABLE ON VIDEO. PICK UP TODAY!

Angelo's CD's & Tapes
 40 W. LITTLETON BLVD #202
 LITTLETON, CO 80120
 303-798-6378

08/17/98 *** Sales Receipt *** 13:47
 Register: 009 Ticket # 47185
 Salesman: 77 Customer: 1
 INHOUSE ACCOUNT,

Part Number	Price	Qty.	Amount
WAULC4049	11.99	1	11.99
RAMMSTEIN	STRIPPED	CD N	
SNY46998	13.99	1	13.99
FRONT 242	TYRANNY	CD N	

Sub Total: 25.98 Sales Tax: 1.77
 Total Sale Amount: \$27.75
 Tender Cash: 28.00
 Change: 0.25

Thank you for shopping at
 Angelo's CD's & Tapes. Please
 come again!

← LOAD THIS DIRECTION, THIS SIDE UP

MONEY ORDER RECEIPT - NON NEGOTIABLE

ACT 097030 DT 101928 \$60.00 ***DOLLARS AND NO CENTS
SERIAL #: 704353178

Payable to:
Please print purchaser's name. It must be included with all refund requests. Be sure to read important information below and on back.
PURCHASE AGREEMENT: You the purchaser agree that Integrated Payment Systems Inc. need not stop payment on, or replace, or refund a lost or stolen Integrated Payment System's Inc. Money Order unless (1) you fill in the "TO THE ORDER OF" line on the front of the Money Order at the time of purchase, and (2) you report the loss or theft to Integrated Payment Systems Inc. in writing immediately.
Issued by Integrated Payment Systems Inc., Empowerd, Canada

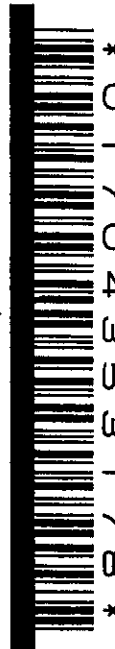

If you need to exchange or return this receipt, please

Hot Topic, Inc. Southwest Plaza

11/17/98
SALESPERSON KELLY
656215 LICENSED ACCESS 1.99

194738 LICENSED ACCESS 2.00
SUBTOTAL 3.99
SALES TAX 0.19
TOTAL 4.18

657671 LICENSED ACCESS 2.99
SUBTOTAL 7.17
SALES TAX 0.14
TOTAL 7.31
CASH 10.00
CHANGE 2.69

THANKS FOR SHOPPING AT HOT TOPIC
Please fill out a comment card.
Check us out on the WEB!
www.hottopic.com

REBISTER# R0006 11/17/98 14:33 #00451

← LOAD THIS DIRECTION, THIS SIDE UP

← LOAD THIS DIRECTION, THIS SIDE UP

MEDIA PLAY #8132
BOWLES CROSSING CENTER LITTLETON, CO
PHONE 933-7510

8132 00012 39557 04/09/98
SALE 551 02:30 PM

6476592	ORBITAL/SNIVILISATIO	
DEPT #12		14.99
8191207	FUTURE SOUND OF LOND	
DEPT #12		13.99
9377045	VAR/TRIP FACTOR	
DEPT #12		13.99
9199134	EAT STATIC/SCIENC OF	
DEPT #12		13.99
9455445	CLOG CDW24/12 WALLET	
DEPT #20		12.99
SUBTOTAL		69.95
69.95	TAX 4.800%	3.36
TOTAL		\$73.31
CASH		80.00
CHANGE		-6.69

MONEY ORDER RECEIPT - NON NEGOTIABLE

ACT 097030 DT 101508 \$12.50 ***12DOLLARS AND 50CENTS
Serial #: 704333179

Printable to:
Each time purchaser's copy, it must be included with all refund requests. Be sure to read important information below and on back.
PURCHASE AGREEMENT: You the purchaser agree that Integrated Payment Systems Inc. need not stop payment on, or replace or refund a bill or submit Integrated Payment Systems Inc. Money Order unless (1) you fill in the "TO THE ORDER OF" line on the front of the Money Order at the time of purchase, and (2) you report the loss or theft to Integrated Payment Systems Inc. in writing immediately.
Issued by Integrated Payment Systems Inc., Englewood, Colorado



← LOAD THIS DIRECTION, THIS SIDE UP

ENTER THE GAME ZONE!!! 100'S OF VIDEO
GAME TITLES!! PSX, SEGA, & N64!!!

Angelo's CD's & Tapes
 40 W. LITTLETON BLVD #202
 LITTLETON, CO 80120
 303-798-6378

03/13/98 *** Sales Receipt *** 16:49
 Register: 010 Ticket # 26124
 Salesman: 64 Customer: 1
 INHOUSE ACCOUNT,

Part Number	Price	Qty.	Amount
IMPRT1002	29.99	1	29.99
IMPORTS	IMPORTS CD'S	MP N	
IRP535006	14.99	1	14.99
ORB	UF ORB	CD N	

Sub Total: 44.98 Sales Tax: 3.06
 Total Sale Amount: \$48.04
 Tender Cash: 50.00
 Change: 1.96

Thank you for shopping at
 Angelo's CD's & Tapes. Please
 come again!

MEDIA PLAY #8132
 BOWLES CROSSING CENTER LITTLETON, CO
 PHONE 933-7510

8132 00013 59447 03/27/98
 SALE 436 02:42 PM

9374406 ORBITAL/ORBITAL +
 DEPT #12 14.99
 14.99 TAX 4.800% 0.72
 TOTAL \$15.71
 CASH 16.01
 CHANGE -0.30

ENTER THE VIDEO ZONE!!! 100S OF VIDEO
 GAME TITLES!! PSX, SEGA, & N64!!!

KMP INC. 1509 QUEEN ANNE AVE. N. #287, SEATTLE, WA 98109

SHIP TO: ERIC HARRIS
8276 SOUTH REED ST.
LITTLETON CO 80128

04605 Order # 3676 Customer #

Money order Payment Method Auth #

ITEM #	DESCRIPTION	SIZE	QTY	SHIPPED	B/O	UNIT PRICE	TOTAL
P101	Blackline-Godlike Poster		1			\$7.00	\$7.00
P404	Tour Poster		1			\$10.00	\$10.00
V4	Video Special		1			\$24.00	\$24.00
R	Reino		1			\$0.00	\$0.00

THANK YOU FOR YOUR ORDER !
B/O = BACK ORDERED
ALL BACK ORDERED ITEMS WILL BE SENT UPON AVAILABILITY
RECEIPT

SUB TOTAL \$41.00
SALES TAX \$0.00
SHIPPING AMOUNT \$4.50
AMOUNT PAID \$45.50

MEDIA PLAY #8132
BOWLES CROSSING CENTER LITTLETON, CO
PHONE 933-7510

8132 00012 29269 04/06/98
551 01:50 PM

9377516 VAR/ULTIMATE IN GABB 13.99
DEPT #12
6169494 FUTURE SOUND LONDON/ 6.99
DEPT #12

SUBTOTAL 20.98
TAX 4.800% 1.01
TOTAL \$21.99
CASH 22.00
CHANGE -0.01

ENTER THE GAME ZONE!!! 100'S OF VIDEO
GAME TITLES!! PSX, SEGA, & N64!!!

8/24/98

25 things that make me different

- 1 My love for a computer game called DOOM. Doom is such a big part of my life and no one I know can recreate environments in DOOM as good as me. I know almost anything there is to know about that game, so I believe that separates me from the rest of the world.
- 2 My dreams. Dreams are one of the most personal things for a person, and I know my dreams separate me from others.
- 3 My car! no one else except my best friend has a little puny car with a RAMMSTEIN sticker on it.
- 4 My bullet ~~is~~ hanging from my rear-view mirror.
- 5 my berserks and zippo that I always have in ~~the~~ my right pocket.
- 6 my backpack. With its customized whiteout writings.
- 7 I can bite off part of a pop can. ~~is~~ using only my teeth.
- 8 My personal views of other people.
- 9 My first impressions of people.
- 10 my penmanship. I haven't seen anyone else write ~~as~~ **neither** quite like I do.
- 11 my knowledge of fireworks.
- 12 my ~~best~~ knowledge of ~~the~~ conventional/amateur explosives.
- 13 my scars.
- 14 My anger management problems.
- 15 my attitude towards people around me.
- 16 My diversion record.
- 17 My friends.
- 18 My patented way of killing spiders and crickets.
- 19 my nickname, just as long as there isn't too many copy cats out there.

JC-001-026187

- 20 My music.
- 21 My fence signs in my room.
- 22 the large collection of bullet shells I have.
- 23 My black box and its contents
- 24 My family
- 25 my memories of the past and hopes for the future

2/1/54

8/24/98

25 ¹ most important thing

Doom is so burned into my head my thoughts ~~usually~~ usually have something to do with the game. Whether it be a level or environment or whatever. In fact a dream I had yesterday was about a "Deathmatch" level that I have never even been to. It was so vivid and detailed I will probably try to recreate it using a map editor. It had 3 ledges and a very high tree-house like area also. But describing it would take forever. What I can't do in real life, I try to do in doom. Like if I walk by a small building I would recreate it as good as I could and then explore it. Go on the roof, under it, or even shoot at it. The fact is, I love that game and if others tell me "hey it's just a game" I say "oh, I don't care"

Music, the music I listen to is fairly unique. However, one must remember that in this day and age, it is almost impossible to be original, so I try to be as much as I can, but I always see someone doing what I do except doing a worse job. I like RAMMSTEIN, KMFDM, 242, ORBITAL, and Lorena McKernitt. So mostly techno/industrial or trance music. I like RAMMSTEIN because they are a German band. Since I am learning to speak German, I know what they are saying. KMFDM is a favorite of mine because of the points they are trying to get across. I'm sure there are others who like my music, but hey, I don't care just as long as they respect the bands.

JC-001-026189

Accomplishment ✓

8/25

A struggle that I had not too long ago was doing community service. I needed to complete 45 hours of comm. serv. by August 3, starting in June. It was part of my Diversion contract, so if I didn't complete it in time, it would be very bad news for my future. Truly, I decided to do my hours at a recreation center called "The Link." It wasn't too hard or harsh, mostly picking up trash or sweeping. Once August 2 rolled around I can recall a few problems, I was scheduled to finish my last 4 hours that day (8/2/90) except that morning I discovered a rather large nail in my left rear tire. That delayed me about 45 min. I showed up at the Link at 2:00 and the 2 men I had been working under all the other days were out of town until Monday morning. Plus, since I didn't know the place closed at 4 on Sundays, that never didn't help much. The man there was nice enough to slide me the extra hour since I did such an outstanding job. So I ended up going back to the Link the next morning to get the final hours slip signed by the head boss there, and then to go pick up my fixed flat tire and then I was off to Holden to see my diversion officer. With all 45 hours done. It made me feel proud of myself for blowing past all problems and getting it all taken care of.

Similes ✓

The swimmers were frightened by the shark and gathered together, like a ~~group~~ school of fish ^{for protection}

She was no longer beautiful at her age, like an old wilted rose.

The mystical ~~man~~ ^{woman} smelled good, like a stroll through an ~~overgrown~~ overgrown flower garden.

1P It was cold & $\frac{1}{2}$ P.J.
we were running late
I was having a bad day

It was cold. A thought that puts the situation ~~light~~ lightly. My squad and I were doing F.T.C.T. which is ~~the~~ frozen terrain combat training. It was another required training program the Corps threw at us. We were stuck in -10°F temperatures without our cold clothes. The transport's door was frozen shut so we were stuck outside in two feet of snow, like being ~~the~~ knee-deep in loose sand. We shook, shivered, rattled and complained like a bunch of little preschoolers on a December morning. My clothes crackled and snapped as I moved. We looked like a group of thin snowmen standing by our transport. The snow was coming down hard and fast, but it ~~was~~ consisted of flakes the size of tiny pebbles. The Corps was going to have a couple of angry machines once we got back to base.

Secret Sharer 1/12

9/2/78

- 1 he is a new captain on an unfamiliar boat with an unfamiliar crew. He doesn't like it.
- 2 they don't like him. To prove himself, he part of the crew.
- 3 when they were in his room, physical features
- 4 his face, whiskers
- 5 he brought down a mast and killed an annoying crew member.
- 6 L shaped he likes him
- 7
- 8 he went to his other self to hear, he shows the captain around
- 9
- 10 very nervous, jumpy
- 11

Is murder or breaking the law ever justified? Explain.



9/2

Yes it is. In extreme situations crime can be deemed insignificant. For example, say John is holding Jill hostage and is threatening to blow up her, himself and a busload of people. He starts a timer that can't be stopped and then a police sniper fires and kills John. Now, murdering John is technically a crime but if he wasn't taken out then lots of people would have died. Another example is, say someone is holding your pet hostage and if you call for help the pet will die. The terrorist tells you to go steal a car for him without contacting anyone for help, I believe in that case grand theft auto is justified. So if the life of many or even one human or even animal is at stake and it is an extreme situation, then breaking the law can be justified. It all depends on the situation there can be several different factors that can all change how the situation is, so I don't think one can say "NO" to the question. There is always an exception.

✓
9/8/98

Macbeth gives me a first impression of a woman who is worn out. She appears tired from stress, hardships, possibly the loss of a loved one, maybe a very hard ordeal such as loosing her queen-rights she is dressed in many colorful but plain clothes drapping down jewelry around her waist and in her 4 foot long red hair. her eyes suggest she is either evil or taken over by evil. Her pale white skin implies that she stays indoors a lot, maybe because she doesn't like people, or the people she is around. She ~~probably~~ probably has children judging from her waist, so she has definitely been through lots of pain and suffering. Maybe she doesn't want the crown.

9/14/98

Open topic ✓

anything but, well let me think here. How about a
train of thought type writing. Maybe, as I know,
I needed to think about my latest Doom 2 level.
It's called Tier 6 and, obviously, is the 6th level
in this series. I have trouble making this one for
some reason though. In the past I have been able
to just go and create several rooms and hallways and
secret rooms just off the Kopf. But for some reason
I can't for Tier 6. Maybe it's the fact that school
is back in session and there is more on my mind
now than there was during the summer when 1-5
were made. I ~~am~~ keep making just plain, boring,
empty rooms like I am a beginner. Just room
after room of the same old stuff. There are a few
places that are indeed good, quality areas that look
better than the original game, but I need to have
the whole level like that. I am trying to go for
a very tough, action packed, fast-paced level because
I just saw "Darius Port: Ryan" again and I want to
kind of recreate some of those scenes best I can.
It's tough though... (no more time)

Open topic /

9/15/98

I had a dream a few nights ago. So I will tell of it. I was walking down a tunnel with a squad of marines. I recognized 3 of my friends and the rest of the squad were just ~~anonymous~~ soldiers. We were all armed and we were on some kind of patrol looking for aliens (like from the movie ALIENS). Then bullets started coming from down the tunnel and hitting the marines in the front. The tunnel was 20 feet wide and high, with a damp, musty, dark feeling to it... (no more time)

JC-001-026196

9/21/98

Summary / Response King Lear.

Out of all of the stories I have read or seen of Shakespeare, this one ~~is~~ was the most confusing and longest. A summary of this story is challenging, but it went something like this: King Lear has 3 daughters and the youngest one of them ~~is~~ doesn't "suck up" like the older ones so the King thinks she doesn't love him. The king gets angry and sends her off. The other two daughters are married off to the rulers of ~~the~~ two other countries. One of the rulers, Edgar, wants to become king so he makes up a couple lies and gets his brother in trouble so he runs off. Meanwhile the king ~~is~~ becomes upset and runs off into the land with his fool. Eventually Edgar's father is accused of being a traitor and has his eyes gouged out by his other sons. Meanwhile King Lear is going insane in the woods and Edgar's brother is running around half-naked in the mud. Later on the king is found (covered with flower necklaces) in the woods and is brought back. The two rulers get into a fight and Edgar wins, the Edgar and his brother fight and his brother wins, the every one of the king's daughters are killed by themselves or by execution, then the king himself dies on top of his now favorite dead daughter and everyone is sad at the end but no bad/evil characters are left alive.

My response to this movie is that it is too complicated and too long. The story itself was definitely well ~~written~~ ^{well} written. The plot is very lengthy and threaded through each character. I noticed a strange lack of symbolism and double meanings. It might have been the fact that I had so much trouble understanding some of the scenes. One form of symbolism I noticed was the use of rain. During one scene when King Lear was out in the rain, he "washed off" all of his hatred for his youngest daughter.

Good to be bad, ✓
bad to be good

9/21/98

A time when it was bad to be good was when I had to give away all my weapons to my parents. It was after I got into serious trouble with the law, so my parents wanted to take all forms of weapons that I had anyway. It was bad not because I might use the weapons, just because I paid good money or spent a lot of time making them. It made me feel that all that time and money was wasted. But since weapons are dangerous and my parents didn't trust me, I suppose it was for the better.

Spit vs. Kiss

9/29/98

It is "sick" because it is only a different way of doing practically the same thing. Kissing is a sign of affection, therefore it is socially acceptable. It has emotional values and it can mean several things, where as swapping spit is just plain, cut, and easily defined. It has no emotional or spiritual meaning. personally I think ~~the~~ both actions are the same

From this poem I see an image of dead soldiers in a field. The field is peaceful and green with small "poppies" in it. But then I see a soldier holding a flag. As that soldier falls another comes up and takes the flag and holds it up high. The fallen soldiers want the living ones to keep faith in what they are fighting for and to keep on fighting. The dead are sad that they died, they miss the sunsets, the dawn, and love. However, the soldiers have escaped the guns of battle judging from what the 1st verse says, "The larks... guns below."

The song deadens the meaning of the poem. It changed into some shallow meaningless song with words when it was ~~just~~ a good poem. That's really about all I can ~~write~~ write about it.



16/12/98

"Trying to define yourself is like trying to bite your own teeth." I interpret this to mean that you can't define yourself. no matter how hard you try or for how long, it is impossible. This is most definitely true. ~~From~~ Personally I have been trying to define who I am, to put myself under some sort of category, to ~~to~~ somehow help myself understand who ~~is~~ I am and what I stand for. It seems like every week my point of view changes on people, but yet it stays the same. What a paradox huh.

Minds change constantly, whenever I try to figure something out that means something to me I can never come up with an exact conclusion. There is always exceptions and stuff. I don't think humans are meant to define themselves, we just make quick judgements and go with that, sometimes we will spend an entire lifetime trying to figure out someone and even after that ~~length~~ ^{length} of time we still can't possibly know everything about that person. The same goes for ourselves, just when we think we know who we are when a new event happens that throws everything we knew about ourselves out the window.

what's 35% of 100 ✓

10/13/98

1. 35
 2. Germany France Spain Italy
 3. Kansas Wyoming Nebraska Arizona
-

I think that this is absolutely ridiculous. people who can't answer questions like that should be shot.

The schools are so caught up on trying to educate students on worthless subjects that they forget about the basics. Now usually for most schools that isn't the case, but if it is for even 1 school that's a big problem. I think students today are astonishingly stupid. It never ceases to amaze me how stupid and ignorant people can be. Seems like some try to be dumb. It's a pity natural selection doesn't apply to humans, otherwise I strongly believe the race as a whole would be better off. I am ashamed to be a part of the same species as some of these people. And to think that this is what millions of soldiers died for and risked everything they had for back in WWII and Korea and Vietnam, and now there are students who don't even know who was involved in the first world war or don't even know when the first atomic bomb was dropped. it is truly pitiful

wat
bx

zen quote

10/15/98

~~There is no reality except~~ There is no reality except the one contained within us. That is why so many people live such an unreal life. They take the images outside them for reality and never allow the world within to assert itself.

I think this is definitely a very true quote. I think it means that people take in images that they see for reality and take what they see in their mind to mean nothing. Except I don't think that is entirely true, people do act on and believe in what they see, but they are still influenced by others. I think people look at others and think that is what they "have" to be like and so they aren't who they are on the outside than ~~to~~ on the inside. People also think that whatever they know and believe in is the only truth, so when something that goes against the grain happens they think it is unreal or can't be happening. I think if more people would let the reality inside themselves come out it would be a different world. Right ~~to~~ now people just think "hey it looks cool to have a strong opinion on something or to believe in something, I think I'll do that too" so they gather up whatever they like about things and try to form a personality out of it, when they should be doing whatever they feel like doing on the inside. If that person wants to be just like everyone else or try to be different just to be different, then ~~OK~~ OK. If they want to try to fly off a bridge, OK. If they want to commit crimes, OK.

Propositions ✓

10/20/98

1. Let's finish the assignment
2. He was interested in and fascinated with physics
3. She had learned of his life and of his times through reading.
4. They were both repelled ^{from} and driven toward the space creature
5. Tell me ^{on what} ~~how~~ he left it.
6. Let's go to James's house tomorrow.
7. She always had an interest in and an aptitude for science.
8. It took a long time to get ^{through} the problem.
9. She looks like her sister ~~and like~~ ^{and like} her mother.
10. Her belief in and dedication to the cause were total
11. His suit, like James's, was grey.
12. The ^{part of the} president's advisor ~~was~~ was investigated.
13. The pitcher's job is more difficult than the fielder's job.
14. The ^{kittens of the} woman's cat ~~was~~ were given away.
15. The ^{speech of the} majority leader of the House of Representatives ~~speech~~ was well received.
16. The final plans of the Boy Scouts of America ^{meeting} ~~meeting~~ were made
17. It was Susan's, Ann's, Joan's, and my idea.
18. The amateur's life differs from the professional's.
19. That is Dr. White and her new house
20. the ~~the~~ ending of the play satisfied the audience

Grammar ✓

10/22/98

- 1 The arrival of many friends promises good times.
- 2 Into the darkness her black cat stares.
- 3 Either the principal or the football coach usually attends the dance.
- 4 Neither the cat ~~or the dog~~ nor the dog is eating today.
- 5 That was the bravest act he ever has committed.
- 6 Mary was friendlier than Susan.
- 7 Scott and I had the perfect evening last night.
- 8 I can buy either the shirt or the scarf. The shirt is the more expensive of the 2.
- 9 She just couldn't start to do homework.
- 10 He could have been a contender.
- 11 She always had an interest in and an aptitude for science.
- 12 She loved him dearly, but not his dog.
- 13 They complimented them both for their bravery, and they also thanked them for their kindness.
- 14 Even though I'm usually interested in Fellini movies, I'd rather not go tonight.
- 15 We read in the paper that they are making great strides in DNA research.
- 16 Harold, in gaping astonishment, watched the painter spill the paint. or Harold watch in ga... ast... as the...
- 17 Jane polished the plate until it almost shined.
- 18 I watched while sitting on the bus, the dog run down the street.
- 19 The clothing was given in large packages to the poor.
- 20 Soft-soled shoes are no good. The coral will cut them to pieces.
- 21 Sharks, for example, live in water.
- 22 The bus, which was ~~scheduled to~~ due to leave for New Orleans at noon, blew up.
- 23 I want to go on a vacation. I have never been more than 30 miles out of this town. I would like to see some new scenery, people, and things. However, I guess vacations will have to wait until I finish my education and earn some money. I lost my job last week after day-dreaming about vacations all shift long.

- 24 Talk softly because people are still studying.
- 25 The trees were sprayed every Thursday; nevertheless, some of the elms were diseased by the end of the season.
- 26 The ferry docked; the passengers disembarked.
- 27 There were five children in the yard; there were toys scattered everywhere.
- 28 The janitor stopped, listened a moment, and then locked the door.
- 29 I want jelly beans, candy corn, and lollipops.
- 30 When he told the joke we stopped and laughed so hard tears were running down our cheeks.

My research subject is a woman who has red hair and blue eyes. I am hoping to research more about her because she is very interesting. I should have gone to the library three weeks ago, but ~~the~~ I waited until the last minute like I always do. It's amazing how well I am at procrastinating. I write really good at the last minute. One quote I have found really defines my subject; "she has stars in her eyes and moonbeams in her smile." It's from a bibliography entitled, "sunshine makes me Me," by Joe Bag-O-donuts. I am really excited about this research paper, because its step-by-step approach really helps me work.

Précis

11/10/98

Americans are very interested in music, even though many just sit back and listen to it rather than make it themselves. Many reasons, such as laziness, lack of discipline, and ignorance keep our musical experience largely receptive and not creative.

death
winter
family rebirth
spring
summer
life
fall
dying

Notes

The Maiden

Mayday dance / festival - rites of spring

Tess - fertility - white dress, purity innocence, red appearances,
sheltered 16-17 yrs old. . . pride, responsible, makes sacrifices, beautiful.

Parson T. calls Jack Durbeyfield "sir John" - begins to act
wealthy - though he's poor

Alec stakes: fancy, con, arrogant, made Tess let him kiss her, kiss of mastery

Tess is trapped

Tess was fated into a poor irresponsible family.

horse accident - feels obligated to go to Alec's to ~~earn~~ for new horse
name - D'urberville

Trapped by Alec on carriage

Trapped by Car Darch + gang in fight, Alec comes to rescue

Forest named "The Chase", Alec and surroundings are black,
Tess is white

innocence - experience

Themes in Tess

- Fate controls much of human destiny
- individual action should not be judged solely by social standards
- Rigid ways of thinking deny individuality
- Industrialization brings an end to traditional rural life and values. (old vs. new)

Tess maiden - Maiden no more

Fate - the fortune teller
mentioned directly → Tess would marry some noble gentleman.

Tess viewed the world as "blighted star"

she is unlucky

↳ often not her fault

Tess' choices

Pride - refuses to allow someone else to take hives

Claim Kin - pressure from mom, "I'll go"

↳ chose to go with Alec

Old vs New

old - Durbeville

simple plain

true D'urberville (old name)

field = farm, country

Sign. Pantar

new

D'urberville

- modern house

- recent man-made descent

- fashion, society

- own carts, carriages

- ville = village, city, town

change in Tess

maiden → no more

Lost: innocence, self-respect, hope/outlook on life

Mom is upset w/ Tess because she can't home not married

- "you never told me about men!"

Pride responsibility,

Guilt, it's my fault

She loses her innocence, she ~~grows~~ grows up.

Baptism scene

"Sinner" doing a reverend's job

Sorrow: if you sin → brings sorrow

~~One~~ One Chase Tess = Theresa
simple plain short

The Rally ————— opens in May (reborn month)
opposites: goes north, bad things happen, goes south, good things
people are nicer

Angel vs Alec = opposites in character, in Tess's feelings, way they
treat her

- Valley of the Great dairies
| bigger and better, she is closer to nature
- her departure - it was her choice, no pressure
- Tess is more independent vs relying on Alec and Poulton farm

Angel = Tess's guardian angel

- feels more secure around him than Alec
- Father = Rev. Clare, Angel is a god fearing man
- Truthful, a gentleman condescending to be a Farmer ^{will own + work sheep}
- NOT going to school - b/c father feels edu. is only
as prep for church
- Angel can't become a parson / follow father b/c he
can't accept Article 4, ~~no~~ ^{no} ~~rule~~

Angel's father - taught painter to paint vicious
- earnestest man in the area
- high standards
- eager to preach - to condemn
- very strict - traditional, (conservative) firm in his values

Angel - Tess

See only the best in each other - don't take time to look for/
recognize any faults

Angel sees Tess as "fresh virgin daughter of nature"

sees her as "visionary essence of woman."
↳ Artemis - is virgin hunter
Demeter - goddess of fertility
ironic

Tess sees him as an Angel - ~~Flaw~~

regards him as an intelligence rather than a man

Jack Dollop story

~~Girl~~ Girl mirrors Tess

irony - when Tess leaves, the butter comes out
serves to reemphasize past

- society's views/thoughts always present

The Rally 3

This phase was opposite from the first and second because of several things. First, she has a job she somewhat likes, second she seems happier at the farm than she did in the past. The farm is full of life and she likes it there. Plus I think the fact that she is milking has something to do with goodness. Milk is ~~is~~ something from mothers, something pure. Plus it is white, which is good. Also, instead of being pursued by someone she doesn't like, she is pursuing and being pursued by someone she loves. Angel symbolizes Tess's ^{guardian} guardian angel, she feels secure around him. Angel is a truthful man. Angel's father is ~~so~~ strict, he sets very high standards and likes to condemn people. He is firm in his beliefs and believes in tradition. He's very conservative. This affects Angel in a way that he probably feels more inclined to rebel. Angel also seems pretty independent, so his father probably doesn't affect his views too much. Tess and Angel resemble Romeo and Juliet. They totally idealize each other and don't look at the "bad" things about each other. Angel sees Tess as a young beautiful "essence of woman". He refers to her as a "fresh virginal daughter of nature." He often would watch her a just day dream about her. he would refer to her as Artemis, which was a ~~sex~~ virgin hunter. Also as demeter, who was the Goddess of fertility. So he basically sees her as an innocent, beautiful woman. Tess sees Angel as the big strong smart older man. She sees him as an angel. His music with the HARP is pretty bad, but she sees his music as absolutely beautiful. She thinks of him

as an intelligence rather than a man. When she is being carried through the water she stares at his face and admires all of his features. Dairymen Crick's story about the butter churning hits home in Tess's mind. The story was about a man named Jack who fooled around a lot and slept with this young girl. She is then left by Jack and her mother comes looking for him. He then hides in the butter chloamer. Which is why the butter, supposedly, doesn't come out. The girl in the story mirrors Tess so when everyone else laughs at the story, she takes it personally. So it kind of keeps what she did fresh in her mind. Well, judging by the title I assume her and Angel will do something which hurts each other and something bad, again, will happen to Tess. or Tess will be haunted even more about what her and Alec did and something will come of it.

consequence 4

love doesn't make
an acceptable marriage

1. - selfish, but wants to not rush in, testing love
- wants to visit? he wants his family's opinion
2. rebel/opposite but still wants to please parents
he thinks of them as arrogant, close minded, snobish. he is more worldly
3. ? persistent don't accept no for answer, persistent

4. I don't treat Tess for who she is, what she knows, skills

Angel feels deeply, cares for her

Alec just likes her beauty

5. Yes she must confess, be truthful. it will always eat away at her if not

6. Jack Collop ^{story} mirrors Tess's life

ashamed of Tess

months before she meets his parents

secluded Inn

doesn't read banns, thought license would be "quieter"

wants to mold

Superstitions

* Jack Dollop (2)

mirrors Tess's life

Fate - story comes just before his proposal

* * Putter wont come / cows go dry

Tess affects natural world

* Tess worries her white wedding dress will change color

superstition driven by social standards

* d'Urberville coach

old super → coach is seen by d'urb when someone has committed a crime ← the way society views Tess's marriage w/out telling him

* * Rooster crowing in afternoon

towards clare - ill omen

* * rains after wedding

sadness/sorrow, bad luck

* wedding on New Years Eve

sign. change next year will be completely diff.

* Portraits of d'Urberville "ladies"

sketched in stone, will never change

* Mom puts faith in Fortune Teller book

Appearance vs Reality

Tess

Angel - attempted independence but when it came down to it he went back to early teachings
show of them at dairy after fight

sleepwalking - relationship is "dead dead dead"

subconscious loves her, conscious doesn't

Homecomings

Tess mom - you fool dad - doubts her

Angel reads passage about virtuous wife. he lies

Izz ~~hoett~~ - hypocrit, mention of Tess brings him back

"you were more sinned against than sinning"
 - parents
 - Alec
 - Angel

Flintcomb Ash

love burnt out, wasted, dead, dark

Winter-Death

Trapped

at Flintcomb Ash, signed contract till spring

Farmer's guy Angel punched

Appearance -

Journey to vicarage:

Fate: to meet / overhear brothers at inopportune time

↳ "greatest misfortune of her life" - was assuming the
: that would be like the bros - so she leaves. 3 pages from end of XLV

↳ immediately sees Alec
preaching

A line to sum up the book?

Marian: "Tess has no faults, Angel has no faults - so it
must be something outside of them

2 pages from end of XLII

↳ Whose fault? Society?

Angel + Alec mention coach of Durbervilles

Cross-in-hand cross is good right? described as sinister, negative

once a victim always a victim, that's the law

thresh hold - dividing line between one home and
world / Alec and Angel

Mrs Brooks - see the murder

stonehenge - sleeps on altar, wronged society so being
sacrificed

The woman pays

His reaction to Tess's confessions is basically out of character but ~~but~~ ~~still~~ still a bit fair. He is in a bad position now. He needs to forgive his wife and be with her. Even though his parents may not approve and he would be looked down upon by society. Tess is somewhat at fault too. She should have told Angel about her previous encounter with Alec. Angel felt a great deal of disappointment in Tess when she told him of her previous affairs with Alec. He felt that he fell in love with a totally different woman, even though he did not. He is being honest to Tess though. He is not hiding his anger and pain. It probably would have been worse for ~~the~~ both Angel and Tess if Angel would have kept his feelings shut inside. It is somewhat expected/predictable of Angel too. He was brought up to believe that he was in a higher class than "cottage girls" and that in almost all cases, women serve the men. The women are supposed to forgive the men for lots of things but men forgiving women for their sins is much less common. So he might be expected by his family (mother, father, and older brothers) to act this way. The double standard theme type deal is used often in this section, a double standard is basically when something is standard for one person ~~to~~ or group of persons, and another standard for a different person ~~to~~ or group of persons. In this case of double-standards,

yes / A

Tess confesses her encounter with ~~Angel~~^{Angel} and he won't forgive her. But earlier when Angel told her about his little fling in London, she forgave him. So therefore I guess it is ok for Angel to have sex before marriage; but not Tess. But that brings up another thing, maybe the only reason Tess forgave Angel so willingly was so he would forgive her, maybe she was thinking "well hey, if I forgive him for his affair, then once I tell him I was raped and had a baby he will lighten up a little quicker."

Maiden

- Tess, as she is first introduced, has several distinct characteristics. She is not afraid to tell her friends what she thinks and she has a lot of pride in her family. This, the pride in her family, is demonstrated within her remark when her father rides by in his carriage thinking he is a great nobleman or something. She snaps at her peers when they make fun of her and her father. She is still very young and quite innocent. Her dress, being the pure color of white, implies her innocence and purity (white always symbolizes purity and innocence, like how angels and pictures of heaven are white). She lives in a cottage in a somewhat secluded town, so she doesn't really have many experiences with the world and the problems it contains. She is somewhat sheltered and shielded from mainstream society. She also seems very forgiving and kind hearted. She will probably grow up and be used because of her natural qualities.
- Irony is definitely used a lot in this novel, and one good example is when the Parson calls Dick Durbeyfield "Sir John". Dick Durbeyfield is just walking home one afternoon minding his own business after slacking off all day long and having a few drinks at the local bar when the Parson refers to him as being a descendant of an old noble family. Calling him Sir John when he is acting like a piece of white trash is most extensively ironic. Another example ~~of~~ ^{that} Harper uses is

when Tess goes to Alec O'berville to claim family kinship Alec O'berville isn't even a true O'berville. His father took that name when they moved to the town because he thought it had a good reputation.

So here is Alec appearing to be of a good noble family and all high and mighty when he is really just a traveling man who put on a little more show to fool the locals.

• On the birth chapter when she tells her younger 9 year old brother that the world is a blighted star she means that they live boring lives and that she is just mad at the whole world. She feels that if she lived on a better star she wouldn't be hauling these bee hives in the middle of the night because of her drunk lazy father. She also feels that the cute rich boy at the dance would have talked with her if she lived ~~on~~ on a better star. She is just mad as hell at people and the world but is too nice to show it which is bad because not showing your true emotions eats you up inside and makes you get depressed. so she is basically saying "brother, this world sucks"

• Tess tries to be responsible, but her first actions often lead to her making things up, or her family pride leads her to do things that she does not really need to do herself. At the dance she stays all night dancing and playing around, disregarding her mother's orders for her to be home hours before she actually got home. So when she does finally get home.

she is all sorry and tries to make it up by doing chores, but her mother all ready did all the things that need to be done so there are not anything left for her to do to make up for her staying at the dance so long.

Then her mother leaves the house to get their drunkness father and leaves Tess in charge of all of the kids, Later she sends Abraham out to find her parents which was not too wise on her part, then taking responsibility for her parents and her brother, Abraham, not being back yet she leaves the house with all ~~of~~ of the other children asleep to go find the other half of her family. Then, on account of her fathers drunkenness and her family pride, she volunteers herself to take a load of live hives somewhere in the middle of the night, not too smart on her part. Then she falls asleep and crashes the carriage and kills the families horse. so now she wants to make up for this momental screw up. so she goes down to Alec O'berwilled's place to work for enough money to buy her family another horse. then Alec starts hitting on her hard core and things just keep on going downhill for Tess.

- Alec is an immature testosterone charged teenager basically. he tries to act like a gentleman and be all nice and kind and respectful but his immaturity still shows up. like when he drives the cart like a speed demon. he does it

because its fun for him even though he is
scaring the bejesus out of Tess. he just
wont stop pursuing Tess until he finally
rapes her in the middle of a forest ~~that~~
appropriately called "the chase".

MNM

- The title of the phase, which is "Maidens no more", suggests that Tess is not a maiden anymore. At the end of the first phase Tess was taken advantage of in the chase by Alec D'Urberville. So therefore she isn't a maiden anymore.
- The man painting the signs is ironic because the signs are what Tess is feeling right now. The signs suggest sins and things which Tess has already committed. So the appearance of the signs and their messages hit home ~~since~~ since she has, in reality, done all of the sins that the messages tell of. So now she is afraid of the damnation she will receive in hell because she let Alec D'Urberville take advantage of her.
- Tess's baby's name is Sorrow, kind of a weird name. To give to your child, unless you knew he wouldn't live very long. The name Sorrow is symbolic because that is the feeling she has for the baby, sorrow. She feels sorry because she let Alec take advantage

Intro

the of
Hardy uses ~~the~~ baby ~~and~~ Alec and Tess to crit.
Vict. Soc. by how Alec reacts, how people treat her,
and by how her family treats her.

I: Alec treats Tess as if she needs to be his wife because
he thinks so, and because he had sex with her.

A) as far as Vict. standards go, Alec should be able to
marry Tess. she doesn't want to, so she is criticized for it.

B) People have pity for Tess since she was raped, so therefore
they get bitter towards Alec and the ~~views~~ ^{views} he ~~has~~ has

II: People treat Tess poorly and look down upon her because
she had a baby without being married.

A) Hardy ~~created~~ ^{made} Tess have a sad, pitiful ~~image~~ ^{image} so
when bad things happen to her the reader blames society.

B) People are against her because of their social standards
when they should be more humane and help Tess / side against Alec.

III: Family acts as if she should have married Alec and
not act like such an individual.

A) they call her a fool and make her feel bad for making
her own decisions.

B) they don't help her w/ the baby at all because of
their social beliefs.

1. Choose one aspect of the novel that Hardy uses to criticize the conventions of the Victorian Society
2. Choose one area of the novel when Tess is "trapped" and thoroughly explain the impact it has on her life
3. Jack Dollop-story, cross-in-hand, or Durberv coach and thoroughly explain the significance of the superstition/omen as it affects Tess
4. Fate and its significance

Format

Introduction - I sent response to the question, it is how you would respond if you weren't forced to write an entire page on it.

Body - the body of the essay is usually 3 (or 4) w/ specific examples in support of the answer you present in intro

Conc. restatement of your intro w/ some notes on how the intervening examples clearly support your conc

HOW - study

Outline - have very brief outlines

Don't BS

clearly present supporting evidence, then show that evidence supports your point

Does it answer the question?

make sense

Tess is trapped in Marlott at the beginning of the story and this affects her life because of Alec + because of herself.

I ~~she~~ she is trapped by Alec because she must stay there to earn[#] and she has to obey ~~him~~ his commands and this affects her by driving the "female inferiority" idea into her head.

A: cart - drives crazy - won't stop till Tess kisses him

B: chase - too tired to say "no", lets Alec rape her

~~B~~ C: won't stop bothering her / pursuing her until she gives in

Chase: Tess is trapped in the chase by Alec and it affects her life by ~~having~~ having society look down on her, by having Alec pursue her, and by ~~having herself always feeling bad about the event and it~~ affects her marriage later on in the book.

I Baby: ^A family is disappointed and ^B people look down on her

II Alec pursues Tess

A: lets Alec believe he owns her / responsible for her

B: Alec always wants to help her, wants to make things easy on her

III She has trouble saying yes to Angel, then Angel gets angry and leaves, then she gets back with Alec

story is signif. because it
the Jack Dollop/lettet her life ~~because~~ by delaying
her decision to marry Angel, by making ~~her think she~~
her know that societies thoughts are always present, and
by making her remember the past.

I - Delays her decision.

A: thinks she isnt worthy

B: reminds that Alec -should- be her husband

II - Society is always going to look down on her

A: fellow maids laugh at story/her

B: realizes that no matter where she goes society will
always look down on her

III she remembers her past

A low self esteem,

B feels unworthy

Fate - Parson

JC-001-026230

285

**NAME POEM
ERIC DAVID HARRIS**

**Enticing
Ready to help
Intriguing
Careful**

**Daffy
Amazing
Victorious
Intelligent
Dependable**

**Humorous
Artistic
Rebel
Reliable
Imaginative
Sarcastic**

-ERIC HARRIS-

I AM POEM

Eric Harris
per. 6
10/30/95

I am a nice guy who hates when people open their pop can just a little.

I wonder what my soccer team will be like in the Spring.

I hear myself turning on the ignition of an F-15.

I see myself flying above everyone else.

I want to fly.

I am a nice guy who hates when people open their pop can just a little.

I pretend I am walking on the moon.

I feel that I will get straight A's again.

I touch the sky.

I worry that I will have a fire in my house.

I cry when I see or hear a dog die.

I am a nice guy who hates when people open their pop cans just a little.

I understand how to play soccer.

I say that a sport is something that you have to break a sweat in.

I dream that I am the only person on Earth.

I try to be as nice as I can.

I hope there isn't another O.J. trial.

I am a nice guy who hates when people open their pop cans just a little.

*Some interesting
notes -
various!*
AAA

ORIGINAL

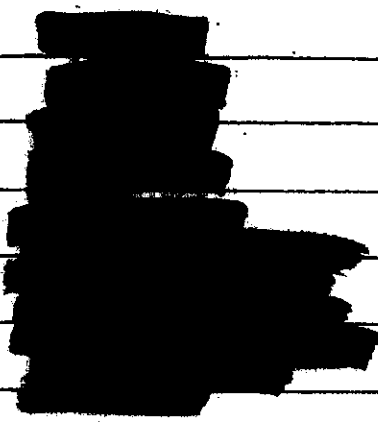

0

/

The document described below
has been removed

Description of Document: Eric Harris'
Columbine High School Yearbook (not
produced with the exception of Dylan
Klebold's writings to Eric Harris).

Date of Document: 1998

Reason for Removal

- Copyright
- Bomb-making instructions
- Medical Records
- Other

Comments: No adequate means to redact
notes written on pictures of students.

MORE

than
masses



photo by Brett Honeycutt



photo by Meagan Stirling

MORE

than
mental

MORE

than
mortals



photo by Jackie Tetreault



photo by Meagan Stirling

MORE

than a
master list

People

Seniors

←-VODKA->

... continue where you see
this ...

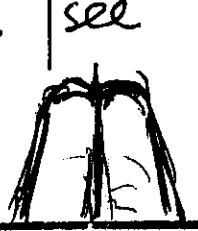

Book 1
Knee Deep in the
dead



thoody shit... it would take the
whole fuckin book to record &
left out everything this year, so just do
main things ill have to cover. Us &
Zack got the BEST Fuckin spots haha
fag jocks have to set their doc martins
wet. DIEEE This is next year's
section. BLFF will be fuckin chaos,
video padwalkers, - i still have the list of
our videos. I cant wait to dub the
new freshmen, & the holy April
morning of NBK...

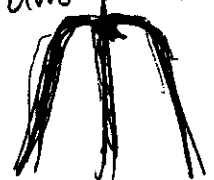



photo by Meagan Stirling

MORE
TO
COME



photo by Meagan Stirling



photo by Meagan Stirling

1998 Rebellations
Volume 25

Columbine High School
Established 1973
Population: 1908
201 South Pierce Street
Littleton, Colorado
80123
(303) 982-4400

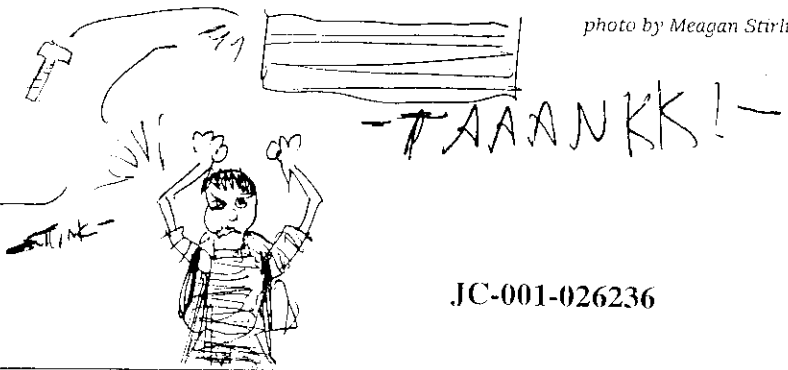

JC-001-026236

BOOK 2: HELL ON

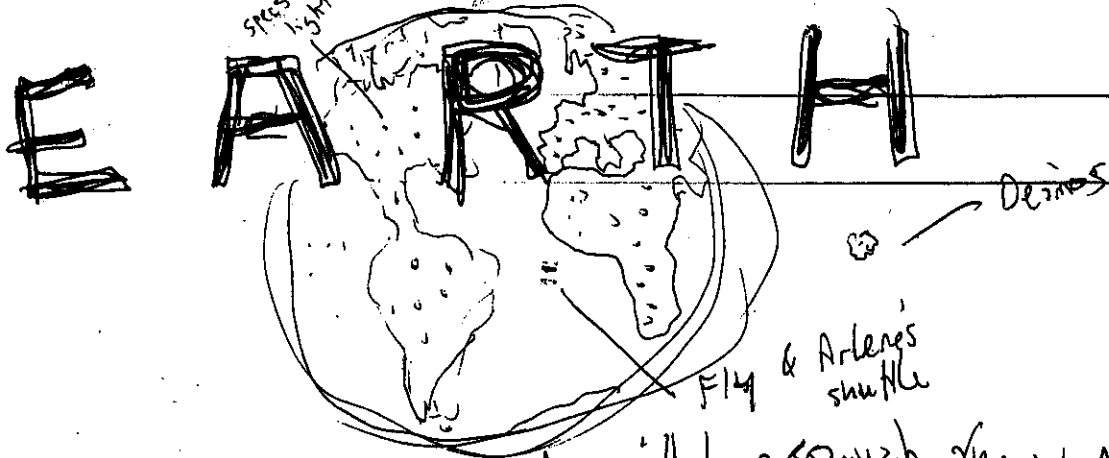

Ahhhh, my favorite book. We, the gods, will have SO much fun w/ NBK!!
killing enemies, blowing up stuff, killing cops!! My wrath for jannan's
incident will be godlike. Not to mention our revenge in the commons.
GAWWWD SOOO many people need to die. & Now, a fun look at
the past: (science-desk style) ((you know what I hate??))
PEOPLE!!
YEAH!!))

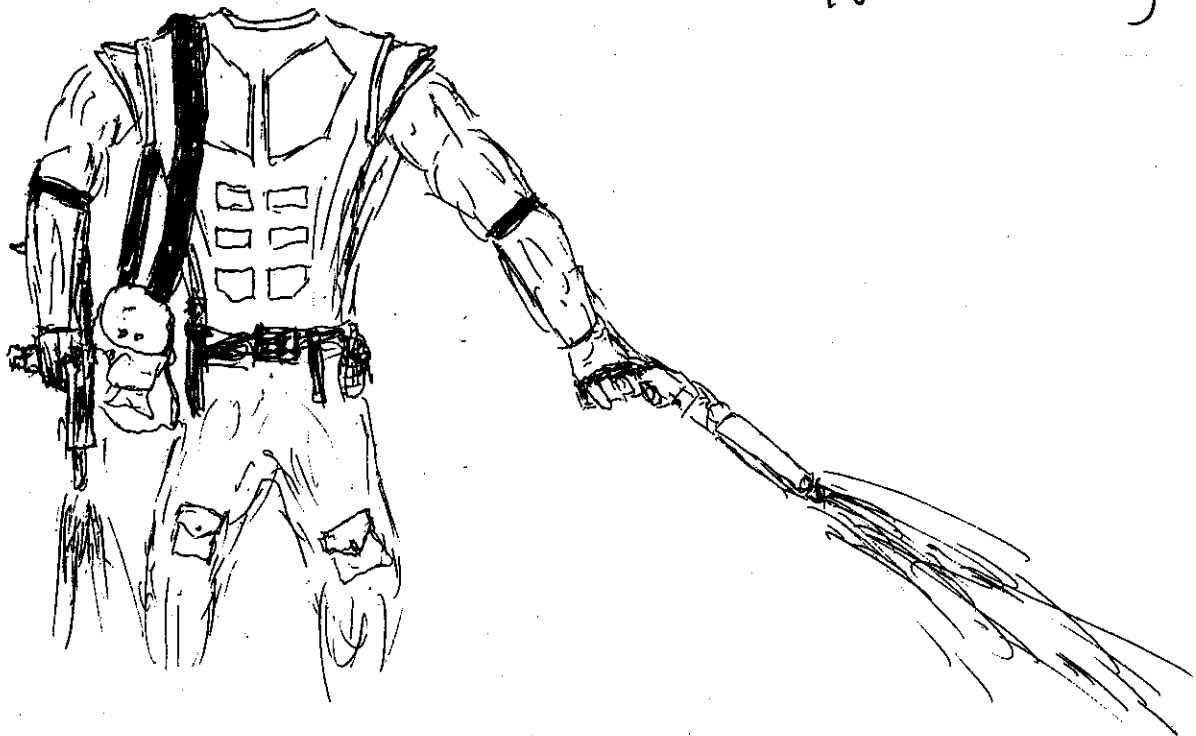

(Back of
h:16)

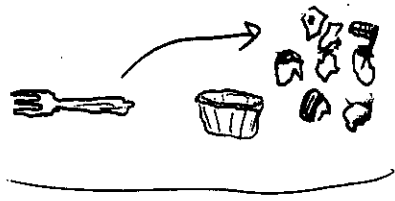

Book 3: Infernal Sky

Man... lets sum up ^{Junior} ~~senior~~ year w/le
(cool shit atleast: sitting in the commons clubbing
& laughing at fags. (WOOD-JA!) NAWAHA

(wannabe)

frisbee fags... orange monitors for them
all the midnight bowling & pool, the KMFDM &
RAMMSTEIN concerts, the RMS when shit went
off, ALL over deathmatches & quake sewing.
I've found that, over the years, we cant beat
eachother: its equal as a nigger to a ~~spade~~
waterworld, EVERY year we get burnt... ^{spade} of course.
all the amp, shit we've seen, stroke! (NIPPLE-FU!)
we need to find (cavegirl) ~~island~~ island &
every gold for home entertainment
Berlin the shit ~~out~~ out a boxes, **SUPA**
Blackjack, smokin behind BJ, **NIGGA!!**
Pines, both kickass 4ths of July...
it was **FUCKIN**
BY DASS!!

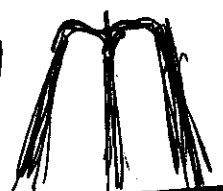

MY QUOTES

• Dead people are the best companions, other than weapons.

• There are more than 99 ways to die... & I thought of them!

• If I don't like them, then they should change, or die.

• My black blood & yer white flesh.

• To find a similarity between people & doom zombies.

• Stupid people are here for my amusement.

• The reason people piss me off is to test my trigger finger, & my adrenaline.

to Ramstein
"Computer" is
speit!
(need
jump →)



Sastages!

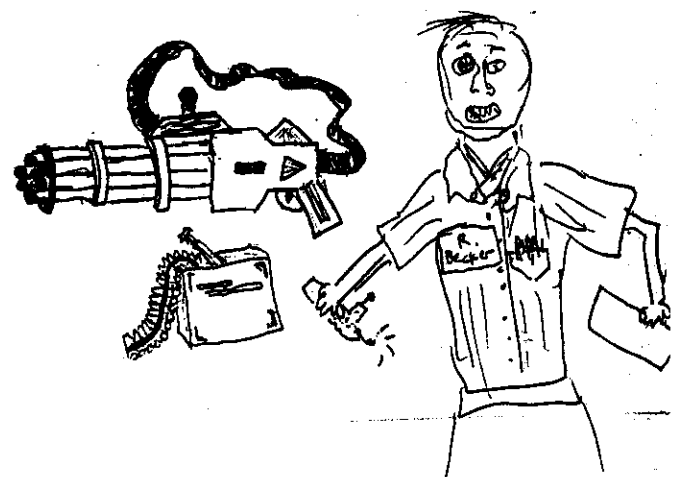
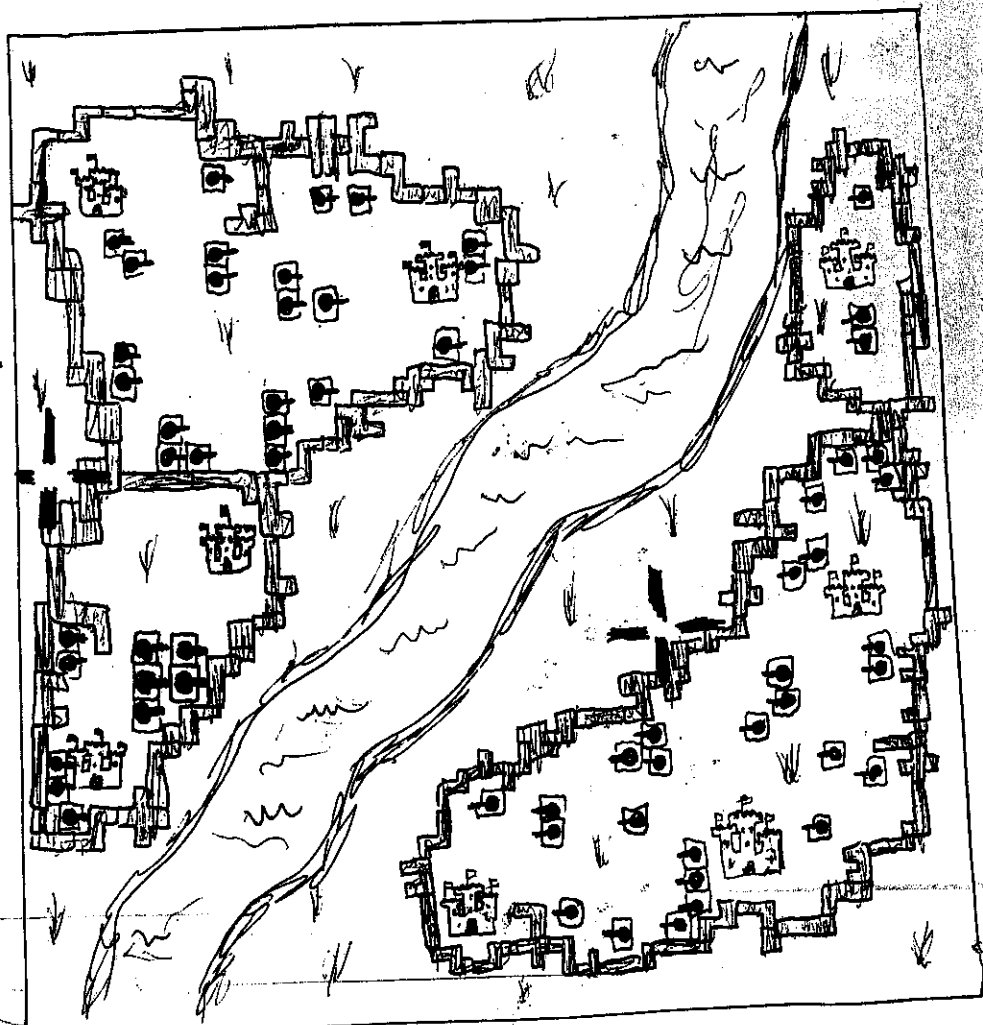

JC-001-026240

Books ~~4~~ : Endgame (?)

Last written book, none to come. I want bare
you w. advice shil you already know. NBK will
be the ultimate revenge, to our shillists, the pigs,
everyone! we'll fuckin 'Take care of business'

to be sure. So, Indigo, As we near
the day of fate ... AAAA FUCK IT!

just let it come. They will know
when gods get pissed off... the
little pussies will feel the shotgun shells &
the bullets. Just like that little ~~o~~ niglet
at comm. service. They need to die soon bad.

now they will.

←-VODKA->

LATER (GREEN)



0 1 2 3 4 5 6 7 8 9 10 11 12 13 14 15 16 17 18 19 20 21 22 23 24 25 26 27 28 29 30 31 32 33 34 35 36 37 38 39 40 41 42 43 44 45 46 47 48 49 50 51 52 53 54 55 56 57 58 59 60 61 62 63 64 65 66 67 68 69 70 71 72 73 74 75 76 77 78 79 80 81 82 83 84 85 86 87 88 89 90 91 92 93 94 95 96 97 98 99



THE GREAT SEAL OF THE UNITED STATES OF AMERICA
1787-1987

JC-001-026242

SCHOOL MASCOT:

REBEL

SCHOOL COLORS:

BLUE AND SILVER



SCHOOL MOTTO:

"Stretch for Excellence"

COLUMBINE HIGH SCHOOL
"STRETCH FOR EXCELLENCE"
6201 South Pierce Street
Littleton, Colorado 80123

At Columbine High School we will Teach, Learn, and Model life skills and attitudes that prepare us to:

- Work with People
- Prepare for Change
- Think Critically
- Act Responsibly
- Live in Harmony with Others and with Our Environment

ADMINISTRATIVE STAFF

PRINCIPAL
Frank DeAngelis

ASSISTANT PRINCIPALS
Kevin Land—Athletic Director
Karen Studenka—Curriculum Director
Maria Reschke—Activities Director

DEAN OF STUDENTS
Peter Horvath—9th & 12th Grade Attendance/Discipline
Chris Mikesell—10th & 11th Grade Attendance/Discipline

THIS BOOK BELONGS TO:

Name _____ Grade _____
Address _____ Phone Number _____
City/State/Zip _____

JC-001-026243

1998-1999 DAILY BELL SCHEDULES

REGULAR SCHEDULE

Period 1 7:30-8:20
Period 2 8:25-9:20
Period 3 9:25-10:15
Period 4 10:20-11:10
Period 5 11:15-11:45
Lunch A 12:10-12:40
Lunch B 11:15-12:05
Class 11:50-12:40
Class
Period 6 12:45-1:35
Period 7 1:40-2:30

LONG ASSEMBLY SCHEDULE

(65 MINUTES)

Period 1 7:30-8:10
Period 2 8:15-9:00
ASSEMBLY 9:05-10:10
Period 3 10:15-10:55
Period 4 11:00-11:40
Period 5 11:45-12:15 Lunch A
12:30-1:00 Lunch B
11:45-12:25 Class
12:20-1:00 Class
Period 6 1:05-1:45
Period 7 1:45-2:30

SHORT ASSEMBLY SCHEDULE

(30 MINUTES)

Period 1 7:30-8:15
Period 2 8:20-9:10
ASSEMBLY 9:15-9:45
Period 3 9:50-10:35
Period 4 10:40-11:25
Period 5 11:30-12:00 Lunch A
12:20-12:50 Lunch B
11:30-12:15 Class

LUNCH A	LUNCH B
Business	Art
Foreign Language	Life Management
Intervention Services	Math
Language Arts	Music
Social Studies	P.E.
Tech. Arts	Science

1998-1999 Important Dates

AUGUST

- 11..... Senior/Junior Registration
- 12..... Sophomore/Freshman Registration
- 11-14..... Schedule Change Requests
- 14..... Last Day For Schedule Changes
- 13..... Teachers Report
- 17..... 1st Day Freshmen Only- Orientation Day
- 18..... 1st Day of Classes-All Students, Semester 1
- 26..... School Picture Make-Up Day
- 27..... Back-To-School Night

SEPTEMBER

- 7..... Labor Day - NO SCHOOL
- 25..... End 1st Six-Week Grading Period
- 30..... Report Cards in 2nd hour Classes
- 28-Oct3..... Homecoming Week

OCTOBER

- 2..... Homecoming Game
- 3..... Homecoming Dance
- 6..... Retakes for Students and Faculty
- 7-8..... PLAN Test - Sophomores
- 12..... Vision/Hearing Screening
- 13-14..... Parent/Teacher Conferences
- 16..... NO SCHOOL
- 17..... PSAT Test
- 20-31..... Registration Semester Two

NOVEMBER

- 6..... End 2nd Six Weeks Grading Period
- 11..... Report Cards in 2nd hr. Classes
- 26-27..... Thanksgiving Holiday-NO SCHOOL

DECEMBER

- 16-17..... Final Exams for Sem. 1
- 18..... Make-Up Day for Sem. 1
- 18..... End of 1st Sem. Grading Period
- 21-Jan 1..... Winter Break-No School

JANUARY

- 4..... Teachers Report - Student Non-Contact Day
- 5..... Registration 2nd Sem. - Student Non-Contact Day
- 6..... First Day of Classes, Semester 2
- 18..... Martin Luther King Day - NO SCHOOL
- 25-29..... 8th Grade Registration Ken Caryl
- 26..... 8th Grade Parent Meeting

FEBRUARY

- 9-14..... Recognition Breakfasts
- 12..... Columbine Area Inservice - NO SCHOOL
- 15..... Presidents Birthday - NO SCHOOL
- 19..... End 1st Six Week Grading Period
- 24..... Report Cards in 2nd hr. classes

MARCH

- 4..... Senior Assembly/Class Picture
- 11..... Parent/Teacher Conferences
- 12..... NO SCHOOL
- 15-19..... Spring Break-NO SCHOOL

APRIL

- 9..... End 2nd Six Week Grading Period
- 14..... Report Cards in 2nd hr. Classes
- 17..... Prom
- TBA..... Caps & Gown Distribution

MAY

- 5..... Stretch for Excellence
- 12-13..... Senior Finals
- 14..... Seniors Make-Up Day
- 21..... Class Day
- 22..... Graduation
- 25-26..... Finals
- 27..... Finals Make-Up Day for Sem. 2
- 27..... Last Day of School
- 28..... Teacher Check-Out Day
- 31..... Memorial Day

ES:



~~Shells~~



~~Shells~~

~~Shells~~

~~Shells - too much~~

~~Shells - too much~~

~~Shells~~

~~Shells~~

~~Shells~~

~~Shells~~

9 clips - Harbin 9mm carbine

machete

~~shells~~

~~AB-10 - clips~~

~~sling/holder~~

~~clocks~~

~~Batteries~~

~~Shells~~

~~Time Bombs~~

IST 10 THRU 16 : 1998

IST

						1
2	3	4	5	6	7	8
9	10	11	12	13	14	15
16	17	18	19	20	21	22
23	24	25	26	27	28	29
30	31					

SEPTEMBER

S	M	T	W	T	F	S
		1	2	3	4	5
6	7	8	9	10	11	12
13	14	15	16	17	18	19
20	21	22	23	24	25	26
27	28	29	30			

weekly ACTION PLAN

	T	W	T	F	S	S
	T	W	T	F	S	S
	T	W	T	F	S	S
	T	W	T	F	S	S
	T	W	T	F	S	S

make TODAY count

MONDAY

10

- ✓ install CDWR prog
- ✓ setup off #2
- ✓ install CDWR CDROM
- ✓ #1
- ✓ SETUP #1
- ✓ BURN data files
- ✓ setup off #1
- ✓ setup off #2
- ✓ copy data CD works
- ✓ copy CD
- ✓ DVD capabilities
- ✓ CDH Gateway for
- ✓ work books
- ✓ ...

TUESDAY

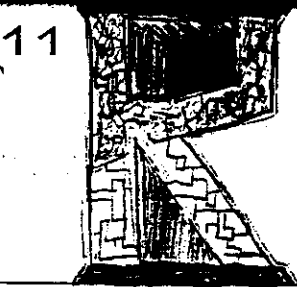

WEDNESDAY

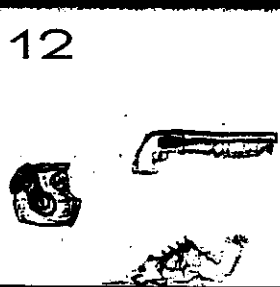

make TODAY count

THURSDAY

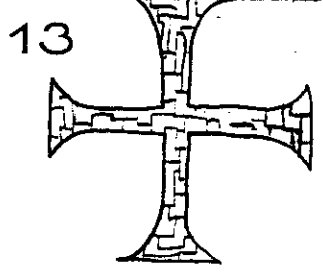

FRIDAY

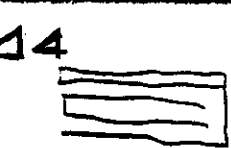

AtN ...

- EDU pens
- shirt
- pouches?
- is news

AUGUST 17 THRU 23 - 1998

weekly ACTION PLAN

AUGUST

1	2	3	4	5	6	7	8
9	10	11	12	13	14	15	16
17	18	19	20	21	22	23	24
25	26	27	28	29	30	31	

SEPTEMBER

S	M	T	W	T	F	S
	1	2	3	4	5	
6	7	8	9	10	11	12
13	14	15	16	17	18	19
20	21	22	23	24	25	26
27	28	29	30			

ME	T	W	T	F	S	S
ME	T	W	T	F	S	S
ME	T	W	T	F	S	S
ME	T	W	T	F	S	S
ME	T	W	T	F	S	S

make TODAY count

MONDAY
17

~~GOV~~ **GOV CON**
article review
due 8/28
Find an article that
you're interested in.
1 IP summarize articles
6 sent
2 IP response, opinion,
6 sent reaction

WEDNESDAY
19 ~~Gov book covered~~
~~bring gym uniform~~
~~gym paper~~
~~signed~~

THURSDAY
20 ~~essay due webb~~

FRIDAY
21
~~Tennis~~
~~team sports~~
nigger = darkie = Kasten = Cohn

SATURDAY
22 **Diversion**
Homework

SUNDAY
23 ~~play tennis~~
~~154~~
Mon - money order
Mon - ~~trick~~
Mon - QP
979-9432

ST 24 THRU 30 - 1998

1ST

29	30	31	1	2	3	4
5	6	7	8	9	10	11
12	13	14	15	16	17	18
19	20	21	22	23	24	25
26	27	28	29	30	31	

SEPTEMBER

S	M	T	W	T	F	S
	1	2	3	4	5	
6	7	8	9	10	11	12
13	14	15	16	17	18	19
20	21	22	23	24	25	26
27	28	29	30			

Weekly ACTION PLAN

	ME	T	W	T	F	S	S
	ME	T	W	T	F	S	S
	ME	T	W	T	F	S	S
	ME	T	W	T	F	S	S
	ME	T	W	T	F	S	S

MONDAY

24

~~Journal due~~
~~SEP~~
 non-sat. coll. rde
 college APPLIC

Journal - 26 things that make me unique

make TODAY count

TUESDAY

25

WEDNESDAY

26

~~scribbles~~

ASSIGNMENTS

~~Assignment~~
 SWAP
 3:00

AFTER SCHOOL PLANNING

SUCCE

struggle

this is v
this sucks

THURSDAY

FRIDAY

SATURDAY

27

~~28~~ ~~study~~ ~~out~~

29

article review

pg 28 1-12-6

voc 96

~~calls~~

~~12/12/6~~

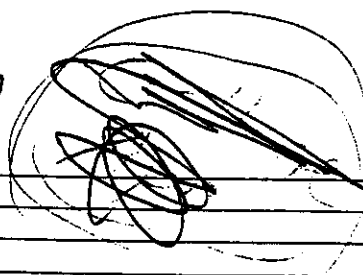
~~scribbles~~

make TODAY count

ASSIGNMENTS

AFTER SCHOOL PLANNING

SUNDAY

30

~~scribbles~~

AUGUST 31 THRU SEPTEMBER 6 - 1998

SEPTEMBER

weekly ACTION PLAN

2	3	4	5	6	7	8
9	10	11	12	13	14	15
16	17	18	19	20	21	22
23	24	25	26	27	28	29
30	31					

S	M	T	W	T	F	S
		1	2	3	4	5
6	7	8	9	10	11	12
13	14	15	16	17	18	19
20	21	22	23	24	25	26
27	28	29	30			

S	M	T	W	T	F	S	S
S	S	S	S	S	S	S	S
S	S	S	S	S	S	S	S
S	S	S	S	S	S	S	S
S	S	S	S	S	S	S	S

MONDAY

TUESDAY

WEDNESDAY

make TODAY count

31 College app due

1 paycheck from T.W.
~~pg 28 + pg 26~~
~~x 6666~~

2 go over can test
 - notes
 - chap 1
 - chap 2
 Secret shares pg 623-648
 questions
 due journal

ASSIGNMENTS

AFTER SCHOOL PLANNING

430

privileg



	THURSDAY	FRIDAY	SATURDAY
make TODAY count	3 classified adds	4 rest of writes Inc words	5
ASSIGNMENTS			4
AFTER SCHOOL PLANNING			

430

SUNDAY

6

4

MBER 7 THRU 13 - 1998

SEPT

1	2	3	4	5	6	7
8	9	10	11	12	13	14
15	16	17	18	19	20	21
22	23	24	25	26	27	28
29	30	31				

OCTOBER

S	M	T	W	T	F	S
				1	2	3
4	5	6	7	8	9	10
11	12	13	14	15	16	17
18	19	20	21	22	23	24
25	26	27	28	29	30	31

weekly ACTION PLAN

	T	W	T	F	S	S
	T	W	T	F	S	S
	T	W	T	F	S	S
	T	W	T	F	S	S
	T	W	T	F	S	S

MONDAY

7 Labor Day

TUESDAY

8

Register
Deposit ISAE

WEDNESDAY

9 *Book*

make TODAY count

ASSIGNMENTS

AFTER SCHOOL PLANNING

JC-001-026253

tolerance

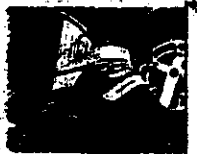
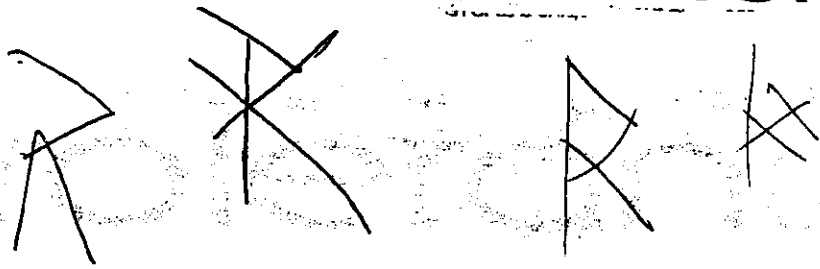

	THURSDAY	FRIDAY	SATURDAY
make TODAY count	10	11	12
		3:30-6 m.x. read AS Rev. 002 Betts - 6th hour	
	Albert - 3:00	4:30 work	read X
	10:100-5-9		
ASSIGNMENTS			10:100-5-9
			SUNDAY
			13
AFTER SCHOOL PLANNING			get commercial supplies ready. pick date.

EMBER 14 THRU 20 • 1998

EMBER

OCTOBER

S	M	T	W	T	F	S
				1	2	3
4	5	6	7	8	9	10
11	12	13	14	15	16	17
18	19	20	21	22	23	24
25	26	27	28	29	30	31

Weekly ACTION PLAN

	T	W	T	F	S	S
	T	W	T	F	S	S
	T	W	T	F	S	S
	T	W	T	F	S	S
	T	W	T	F	S	S

MONDAY TUESDAY WEDNESDAY

14

15 Commercial P
Bring notes CD.

16 Mexican Independence
Day (Mexico)

make TODAY count

4

4

ASSIGNMENTS

AFTER SCHOOL PLANNING

4			
5			
6			
7			
8			
9			

democrac

THURSDAY

17

DAY

FRIDAY

18

vacab
1/15

DAY

SATURDAY

19

-130

~~10/15~~

SUNDAY

20

2

make TODAY count

ASSIGNMENTS

AFTER SCHOOL PLANNING

~~PROGRES
REPORT~~

Dir. Sick
3:30 Golden - 1
Progress Report

JC-001-026256

~~still in school~~
~~at school~~
~~job in training (training)~~
~~at home away (ziploc bag)~~
~~to school~~
~~look for B.D. and P.D. at school~~

THURSDAY FRIDAY SATURDAY

24
 PATRIOTIST

25
 5:15

26 8:30 B.D.
 C.U.
 foot ball game

make TODAY count

ASSIGNMENTS

AFTER SCHOOL PLANNING

memorize Erlkonig

SUNDAY

27 11:00 B.D.

teamwork

Combine the talents of many with the will of one, and you will experience the synergy of team power

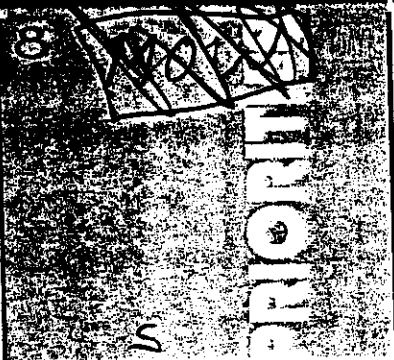
	THURSDAY	FRIDAY	SATURDAY
make TODAY count		9:15 start , gloves DAY if it doesn't 3:30 view	10
ASSIGNMENTS	_____		

AFTER SCHOOL PLANNING	_____ Haley Dan Pamela Leader		
			SUNDAY
			11

leadership

Charisma and confidence boldly lead the way for others to follow.

THURSDAY

FRIDAY

SATURDAY

15

SCRIPES

Handwritten scribbles and notes on a dark background.

16

DAY

5:30

17

Handwritten scribbles and notes.

make TODAY count

ASSIGNMENTS

AFTER SCHOOL PLANNING

NO SCHOOL

SUNDAY

18

2:00

OBER 19 THRU 25 - 1998

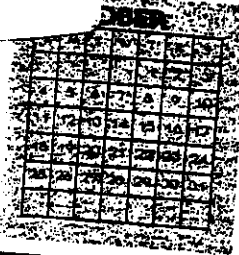

NOVEMBER

S	M	T	W	T	F	S
1	2	3	4	5	6	7
8	9	10	11	12	13	14
15	16	17	18	19	20	21
22	23	24	25	26	27	28
29	30					

weekly **ACTION PLAN**

	M	T	W	T	F	S
	M	T	W	T	F	S
	M	T	W	T	F	S
	M	T	W	T	F	S
	M	T	W	T	F	S

MONDAY

PRIORITIES

TUESDAY 20

WEDNESDAY 21

Albert 3:00

ASSIGNMENTS

AFTER SCHOOL PLANNING

4 5 6 7 8 9

4 5 6 7 8 9

4 5 6 7 8 9

make TODAY count

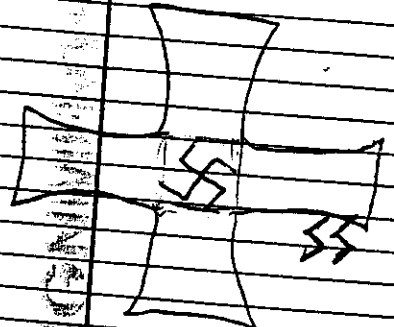

sportsmanshi

Admired is the ability to enjoy accomplishments with humble recognition and to accept losses with quiet acknowledgement.



THURSDAY

FRIDAY

SATURDAY

22 *22*

PRIORITIES

23 *23* *Library sheet*

24
United Nations Day

make TODAY count

ASSIGNMENTS

AFTER SCHOOL PLANNING

SUNDAY

25
Daylight Savings Ends 2:00 am

JC-001-026266

OBER 26 THRU NOVEMBER 1 - 1998

Small calendar grid for OBER 26 - 31.

NOVEMBER weekly calendar grid with days S, M, T, W, T, F, S and dates 1-30.

weekly ACTION PLAN

Weekly action plan grid with days M, T, W, T, F, S, S and blank rows for scheduling.

MONDAY

26 PRIORITIES

make TODAY count

TUESDAY

27 registration review for gov test

DAY

WEDNESDAY

28

DAY

4-8

4-8

ASSIGNMENTS

AFTER SCHOOL PLANNING

2nd banker

Tier 1 story

championship

A champion's attitude is fostered out of years of sweat, determination, and perseverance.

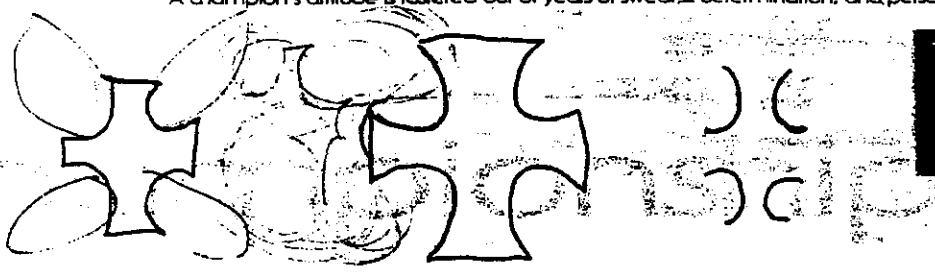

	THURSDAY	FRIDAY	SATURDAY
make TODAY count		30 (DAY) 4-8	31 Halloween 2-7
ASSIGNMENTS			
AFTER SCHOOL PLANNING	2nd bunker 4 5 6 7 8 9	3x1 1/2 CAPS 4 5 6 7 8 9	SUNDAY 1

EMBER 2 THRU 8 . 1998

100 15205

DECEMBER

weekly ACTION PLAN

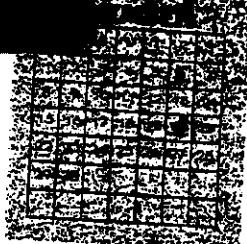

S	M	T	W	T	F	S
		1	2	3	4	5
6	7	8	9	10	11	12
13	14	15	16	17	18	19
20	21	22	23	24	25	26
27	28	29	30	31		

	M	T	W	T	F	S	S
	M	T	W	T	F	S	S
	M	T	W	T	F	S	S
	M	T	W	T	F	S	S
	M	T	W	T	F	S	S

MONDAY

2

PRIORITIES

TUESDAY

3

Election Day

VOCAB DAY

WEDNESDAY

4

3:30 P.M.

make TODAY count



ASSIGNMENTS

AFTER SCHOOL PLANNING

JC-001-026269

aspiration

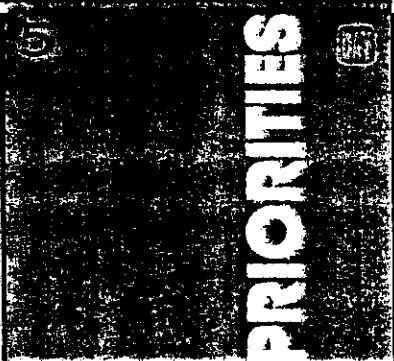
60!

	THURSDAY	FRIDAY	SATURDAY
make TODAY count		8 Malcom X ch 14 	7
ASSIGNMENTS			
AFTER SCHOOL PLANNING	4 5 6 7 8 9	1 2 3 4 5 6 7 8 9	8

JC-001-026270

THURSDAY

FRIDAY

SATURDAY

make TODAY count

PRIORITIES DAY

13

DAY

14

Research paper due

DDC
830-330

ASSIGNMENTS

AFTER SCHOOL PLANNING

SUNDAY

15

1
5
6
7
8
9

practice

THURSDAY	FRIDAY	SATURDAY
<p>19</p> <p>PRIORITIES</p>	<p>20 - 75 in Tess</p> <p>article review - just prep</p> <p>Dentist 3:00</p>	<p>21 Gun show</p> <p>Denver merchandise mart</p> <p>- spotlight -</p> <p>4</p> <p>VOCAB (cont)</p> <p>presentation project</p> <p>- trench coat mafia</p> <p>hit man.</p> <p>ISA paper!</p>
<p>ASSIGNMENTS</p>	<p>wallet pics</p> <p>Tier</p> <p>outback - Katie?</p> <p>movie?</p> <p>Note after school w/ mom</p>	<p>SUNDAY</p>
<p>AFTER SCHOOL PLANNING</p>	<p>22</p>	<p>22</p>

make TODAY count

ASSIGNMENTS

AFTER SCHOOL PLANNING

performance

The spotlight of fame awaits only those who are prepared to perform at the highest level.

performance

	THURSDAY	FRIDAY	SATURDAY
make TODAY count	26 PRIORITIES DAY	27 DAY	28
ASSIGNMENTS			
AFTER SCHOOL PLANNING			
			SUNDAY
			29

vision

Your fate is determined by your vision of the future... expect the

VISION

	THURSDAY	FRIDAY	SATURDAY
make TODAY count	3 PRIORITIES	4 art rev scholarship app paycheck w/ 7.25as rate	5
ASSIGNMENTS		GET BRAKES CHECKED	read like hell
AFTER SCHOOL PLANNING			SUNDAY 6

JC-001-026278

ARY 4 THRU 10 • 1999

3	4	5	6	7	8	9
10	11	12	13	14	15	16
17	18	19	20	21	22	23
24	25	26	27	28	29	30
31						

FEBRUARY

S	M	T	W	T	F	S
1	2	3	4	5	6	
7	8	9	10	11	12	13
14	15	16	17	18	19	20
21	22	23	24	25	26	27
28						

Weekly **ACTION PLAN**

	T	W	T	F	S	S
	T	W	T	F	S	S
	T	W	T	F	S	S
	T	W	T	F	S	S
	T	W	T	F	S	S

MONDAY	TUESDAY	WEDNESDAY
--------	---------	-----------

make TODAY count	4	5 get shit	6 start shit
ASSIGNMENTS			
AFTER SCHOOL PLANNING			

destiny

Your destiny is limited only by your ability to believe in your imagination.

destiny

	THURSDAY	FRIDAY	SATURDAY
make TODAY count	7 DAY	8 DAY	9
ASSIGNMENTS			
AFTER SCHOOL PLANNING			

SUNDAY
10

JC-001-026280

JANUARY 18 THRU 24 - 1999

JANUARY

3	4	5	6	7	8	9
10	11	12	13	14	15	16
17	18	19	20	21	22	23
24	25	26	27	28	29	30
31						

FEBRUARY

S	M	T	W	T	F	S
	1	2	3	4	5	6
7	8	9	10	11	12	13
14	15	16	17	18	19	20
21	22	23	24	25	26	27
28						

weekly ACTION PLAN

MONDAY TUESDAY WEDNESDAY

make TODAY count

18 Martin Luther King Jr. Day (DAY)

19 (DAY)

20 call [redacted] (DAY)

ASSIGNMENTS

DIVERSION IS DONE

AFTER SCHOOL PLANNING

4 5 6 7 8 9

JC-001-026282

effort

The inner drive to outwork your rivals will free you from the momentum of mediocrity

effort

THURSDAY FRIDAY SATURDAY

21 ~~8:30-10:00~~ (DAY)
 read a woa
 Elder God shrine
 get slim jims
 Bring disk for
 pics of intro

22 (DAY)
 [redacted] of [redacted] jus.
 [redacted] hose *
 Bowling

23
 WAXTRAX
 Leave around 11:00

Advice 4:00P

make TODAY count

ASSIGNMENTS

AFTER SCHOOL PLANNING

SUNDAY

24

4
5
6
7
8
9

perseverance

Big ideas happen when you are committed to excellence, dedicated to detail, and determined to never give up.

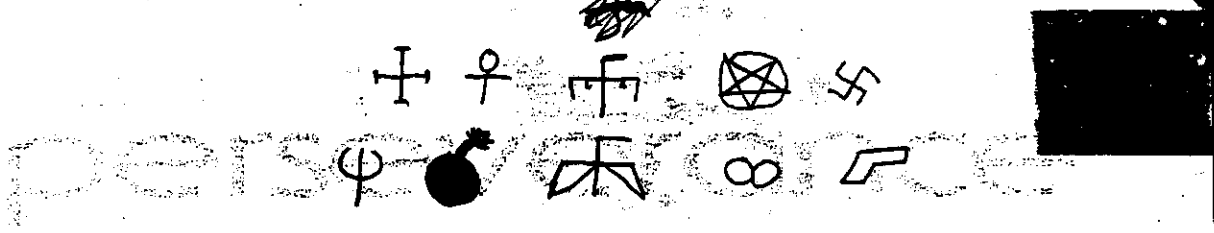

THURSDAY	FRIDAY	SATURDAY
28 DAY	29 DAY	30
ASSIGNMENTS		<i>Hgt topics</i> <i>downstairs?</i>
AFTER SCHOOL PLANNING		



Harmony

The existence of man depends upon the continued existence of nature. Cherish and protect the world you live in.

HA HA!

STANIS

ENVISION - NAVIGATE - MAKE TODAY COUNT

JC-001-026286

consideration

Appreciated are those who thoughtfully anticipate the unspoken needs of others.

THURSDAY

FRIDAY

SATURDAY

make TODAY count

ASSIGNMENTS

AFTER SCHOOL PLANNING

PRIORITIES

12\$ No SCHOOL DAY
530

13 DOWNTOWN
4

SUNDAY

14 Valentine's Day

JANUARY 15 THRU 21 • 1999

JANUARY

1	2	3	4	5	6	7	8	9	10	11	12	13	14	15	16	17	18	19	20	21	22	23	24	25	26	27	28	29	30	31
---	---	---	---	---	---	---	---	---	----	----	----	----	----	----	----	----	----	----	----	----	----	----	----	----	----	----	----	----	----	----

MARCH

S	M	T	W	T	F	S
	1	2	3	4	5	6
7	8	9	10	11	12	13
14	15	16	17	18	19	20
21	22	23	24	25	26	27
28	29	30	31			

weekly ACTION PLAN

	M	T	W	T	F	S	S
	M	T	W	T	F	S	S
	M	T	W	T	F	S	S
	M	T	W	T	F	S	S
	M	T	W	T	F	S	S

MONDAY

15
Martin Luther King Jr. Day
NO PRIORITIES
SCHOOL

make TODAY count

TUESDAY

16

WEDNESDAY

17

Ash Wednesday

ASSIGNMENTS

AFTER SCHOOL PLANNING

ASSIGNMENTS

compromis

Compromise is built out of the strength and open-mindedness to admit that your ideas and opinions may be wrong.

compromis

	THURSDAY	FRIDAY	SATURDAY
make TODAY count		19	20
ASSIGNMENTS			
AFTER SCHOOL PLANNING			
		SUNDAY	
		21	

JANUARY 22 THRU 28 • 1999

JANUARY

1	2	3	4	5	6	7
8	9	10	11	12	13	14
15	16	17	18	19	20	21
22	23	24	25	26	27	28
29	30	31				

MARCH

S	M	T	W	T	F	S
1	2	3	4	5	6	7
8	9	10	11	12	13	14
15	16	17	18	19	20	21
22	23	24	25	26	27	28
29	30	31				

weekly ACTION PLAN

	M	T	W	T	F	S	S
	M	T	W	T	F	S	S
	M	T	W	T	F	S	S
	M	T	W	T	F	S	S
	M	T	W	T	F	S	S

MONDAY

22

PRIORITIES

TUESDAY

23

DAY

WEDNESDAY

24

DAY

make TODAY count

ASSIGNMENTS

AFTER SCHOOL PLANNING

ASSIGNMENTS

4
5
6
7
8
9

JC-001-026291

respek

Respect is too valuable to be given for free. It must be earned through positive words and deeds.

Respek



THURSDAY FRIDAY SATURDAY

25 PRIORITIES

26 DAY

27

make TODAY count

ASSIGNMENTS

AFTER SCHOOL PLANNING

SUNDAY

28

JC-001-026292



It is extremely important to stay focused on your **goals** goals, for it is possible to achieve only what you actively pursue.

HA!



GOALS
STAY
FOCUS

ENVISION - NAVIGATE - MAKE TODAY COUNT

Poster available

JC-001-026293

MARCH 1975

SUNDAY	MONDAY	TUESDAY	WEDNESDAY	THURSDAY	FRIDAY	SATURDAY
28		Purim				
			St. Patrick's Day			Vernal Equinox
Palm Sunday				1	2	3

- LUNAR CYCLE
- NEW MOON
 - ☾ FIRST QUARTER
 - FULL MOON
 - ☽ LAST QUARTER

FEBRUARY

S	M	T	W	T	F	S
	1	2	3	4	5	6
7	8	9	10	11	12	13
14	15	16	17	18	19	20
21	22	23	24	25	26	27
28						

APRIL

S	M	T	W	T	F	S
1	2	3	4	5	6	7
8	9	10	11	12	13	14
15	16	17	18	19	20	21
22	23	24	25	26	27	28
29	30					

JC-001-026294

CH 8 THRU 14 • 1999

ICH

1	2	3	4	5	6	7
8	9	10	11	12	13	14
15	16	17	18	19	20	21
22	23	24	25	26	27	28
29	30	31				

APRIL

S	M	T	W	T	F	S
				1	2	3
4	5	6	7	8	9	10
11	12	13	14	15	16	17
18	19	20	21	22	23	24
25	26	27	28	29	30	

weekly ACTION PLAN

	M	T	W	T	F	S	S
	M	T	W	T	F	S	S
	M	T	W	T	F	S	S
	M	T	W	T	F	S	S
	M	T	W	T	F	S	S

	MONDAY	TUESDAY	WEDNESDAY
8	PRIORITIES	9	10
ASSIGNMENTS			
AFTER SCHOOL PLANNING			

hard work

There is no substitute for discipline, dedication, and hard work. Success will be your reward.

THURSDAY

18

PRIORITIES

make TODAY count

FRIDAY

19

DAY

SATURDAY

20

Vernal Equinox

ASSIGNMENTS

ASSIGNMENTS

SUNDAY

21

AFTER SCHOOL PLANNING

4
5
6
7
8
9

4
5
6
7
8
9

JC-001-026300

5 THRU 11 • 1999

weekly ACTION PLAN

S	M	T	W	T	F	S
1						
2						
3						
4						
5						
6						
7						
8						
9						
10						
11						
12						
13						
14						
15						
16						
17						
18						
19						
20						
21						
22						
23						
24						
25						
26						
27						
28						
29						
30						
31						

S	M	T	W	T	F	S
						1
2	3	4	5	6	7	8
9	10	11	12	13	14	15
16	17	18	19	20	21	22
23	24	25	26	27	28	29
30	31					

M	T	W	T	F	S	S

MONDAY	TUESDAY	WEDNESDAY
--------	---------	-----------

make TODAY count

MONDAY	TUESDAY	WEDNESDAY
	6	7

ASSIGNMENTS

MONDAY	TUESDAY	WEDNESDAY
<p><i>Philosophy</i></p> <p><i>Test</i></p>	<p><i>Voltage increase</i></p> <p><i>Red lamp</i></p>	

AFTER SCHOOL PLANNING

MONDAY	TUESDAY	WEDNESDAY
<p><i>do another</i></p> <p><i>vide</i></p>	<p><i>find other tapes</i></p>	

ingenuity

The ability to find a positive solution where none existed before leads to progress.

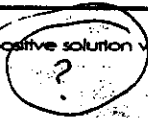

ingenuity

	THURSDAY	FRIDAY	SATURDAY
make TODAY count		9\$ off A/V store	10 ^{off}
ASSIGNMENTS		ASSIGNMENTS	SUNDAY 18
AFTER SCHOOL PLANNING	1 2 3 4 5 6 7 8 9	1 2 3 4 5 6 7 8 9	

enlightenment

Combine knowledge with experience, and it will grow into an understanding.

enlightenment

THURSDAY	FRIDAY	SATURDAY
<p>make TODAY count</p> <p>PRIORITIES</p>	<p>23</p>  <p>9-10 DAY 9-12</p>	<p>24</p>
<p>ASSIGNMENTS</p>		
<p>AFTER SCHOOL PLANNING</p>		

SUNDAY

<p>25</p>

APRIL 26 THRU MAY 2 • 1999

APRIL

1	2	3	4	5	6	7
8	9	10	11	12	13	14
15	16	17	18	19	20	21
22	23	24	25	26	27	28
29	30					

MAY

S	M	T	W	T	F	S
					1	
2	3	4	5	6	7	8
9	10	11	12	13	14	15
16	17	18	19	20	21	22
23	24	25	26	27	28	29
30	31					

weekly **ACTION PLAN**

	M	T	W	T	F	S	S
	M	T	W	T	F	S	S
	M	T	W	T	F	S	S
	M	T	W	T	F	S	S
	M	T	W	T	F	S	S

MONDAY 26 PRIORITIES	TUESDAY 27	WEDNESDAY 28
--	----------------------	------------------------

make TODAY count

ASSIGNMENTS	
	<p style="writing-mode: vertical-rl; transform: rotate(180deg);">ASSIGNMENTS</p>
AFTER SCHOOL PLANNING	
	<p style="writing-mode: vertical-rl; transform: rotate(180deg);">ASSIGNMENTS</p>

teaching

The desire to reach others comes from a need to pay back what was once given to you.

teaching

teaching

THURSDAY		FRIDAY	SATURDAY	
PRIORITIES		30	1	
ASSIGNMENTS		ASSIGNMENTS	SUNDAY	
AFTER SCHOOL PLANNING				



ENTHUSIAST

Happiness doesn't just happen to people... it is reserved for those who are willing to pursue their dreams and live life to the fullest.

These are so Fucking funny!

ENTHUSIAST

ENVISION - NAVIGATE - MAKE TODAY COUNT

Postcard available

JC-001-026311

MAY 1999

SUNDAY MONDAY TUESDAY WEDNESDAY THURSDAY FRIDAY SATURDAY

25

APRIL

5	6	7	8	9	10	11
12	13	14	15	16	17	18
19	20	21	22	23	24	25
26	27	28	29	30		

26

JUNE

5	6	7	8	9	10	11
12	13	14	15	16	17	18
19	20	21	22	23	24	25
26	27	28	29	30		

27

- LUNAR CYCLE
- NEW MOON
 - ◐ FIRST QUARTER
 - FULL MOON
 - ◑ LAST QUARTER

28

Cinco de Mayo
(Mexico)

29

30

Mother's Day
"good wombs have born Bad sons."
-Shakespeare

Armed Forces Day

Victoria Day
(Canada)

Memorial Day

make TODAY count

MONDAY

10

BIRMS

suitcase, black
sheets, duffel
bag,
black duffel
bag

TUESDAY

WEDNESDAY

I have
my
car
in car

5:00 - get up
6:00 meet at KS
7:00 go to Rob's house
7:15 he leaves to fill
propane

I leave to
fill gas

8:30 meet back at
his house

9:00 ~~can~~ make d.b.
set up car.

9:30 practice team

~~Chill~~ chill...
10:30 - set up 4 things

9	M	T	W	T	F	S
10	1	2	3	4	5	6
11	7	8	9	10	11	12
12	13	14	15	16	17	18
13	19	20	21	22	23	24
14	25	26	27	28	29	30
15						
16						
17						
18						
19						
20						
21						
22						
23						
24						
25						
26						
27						
28						
29						
30						

5	M	T	W	T	F	S
6	1	2	3	4	5	6
7	7	8	9	10	11	12
8	13	14	15	16	17	18
9	19	20	21	22	23	24
10	25	26	27	28	29	30
11						
12						
13						
14						
15						
16						
17						
18						
19						
20						
21						
22						
23						
24						
25						
26						
27						
28						
29						
30						

MAY 1999
THUR 46
1999

WEEKLY ACTION PLAN

Passion

Discover your passion and do everything in your power to make it happen.



ADIOS

Home base gas traits

upload Book + Tier pics

haircut

THURSDAY	FRIDAY	SATURDAY
	7	8
How will u get yer gear in car Tom-morrow.	Time schedule	Burn final Tier will revise crickets

#308

JEFFERSON COUNTY PUBLIC SCHOOLS

SECONDARY SCHOOL REPORT CARD

12/18/98

STUDENT: 777592

PRINCIPAL: MR FRANK DE ANGELIS

NAME: HARRIS ERIC DAVID

GRADE: 12

SCHOOL: COLUMBINE SENIOR HIGH

COURSE TITLE	PERIOD	INSTRUCTOR	ABSENCES	COURSE GRADES			FIN	CREDIT
				T 1	T 2	T 3		
VIDED CLASS WORK IS IMPROVING	01	TALCCCO		C	B+	A	A	0.500
GOV/ECON POSITIVE ATTITUDE AND GOOD COOPERATION STRONG INTEREST AND PARTICIPATION	02	TONELLI		B+	B	A	A	0.500
TM SPTS COM	03	PLACE	1	A	A	A	A	0.500
GERM 401	04	BURNETT		A	B	B	B	0.500
CCB/MJBRWR	05	WEBB		B	B-	B	B	0.500

CHS WISHES YOU AND YOUR FAMILY A HAPPY AND HEALTHY NEW YEAR!
WELCOME BACK.

TO THE PARENTS OF
HARRIS ERIC DAVID

JC-001-026315

LITTLETON CO. 80128

JEFFERSON COUNTY PUBLIC SCHOOLS

STUDENT 777592

STUDENT TRANSCRIPT ON 08/21/98

THRU GRADE: 12

HARRIS ERIC DAVID
 [REDACTED]
 LITTLETON CO. 80128
 SSN [REDACTED]
 BIRTH M 4/9/81

GPA: 3.314 COLUMBINE SENIOR HIGH
 RANK: 133 / 439 6201 SO PIERCE ST
 CN: 8/21/98 LITTLETON CO. 80123
 TOTAL CREDITS: 17.50 PARENTS/GUARDIANS:
 ACADEMIC CRED: 14.50 KATHY HARRIS
 WAYNE HARRIS

* ----- SEMESTER 1 ----- *				* ----- SEMESTER 2 ----- *			
----- GRADE 09 -----		95	96	SCHOOL YEAR -----*			
050031	H 95 1 9	LANGARTS	A .50	030100	95 2	KEYBD 1 A .50	
060220	F 95 1	GERM 101-Y	A .50	050031	V 95 2	9 LANGARTS A .50	
103320	95 1	WOOD	A .50	060220	F 95 2	GERM 101-Y B .50	
110531	M 95 1	GEOMETRY 9	A .50	080610	Q 95 2	TM SPRT/CC A .50	
130300	S 95 1	EARTH SC-Y	A .50	110531	M 95 2	GEOMETRY 9 B .50	
150300	D 95 1	AM GOVT	A .50	130300	S 95 2	EARTH SC-Y A .50	
----- GRADE 10 -----		96	97	SCHOOL YEAR -----*			
051011	H 96 1	AMER LIT/C	B .50	051011	V 96 2	AMER LIT/C A .50	
060230	F 96 1	GERM 201-Y	B .50	060230	F 96 2	GERM 202-Y B .50	
110600	M 96 1	ALGEBRII-Y	B .50	110600	M 96 2	ALGEBRII-Y A .50	
130400	S 96 1	BIO I -Y	B .50	130400	S 96 2	BIO I -Y B .50	
151200	A 96 1	AM HIST -Y	B .50	151200	A 96 2	AM HIST -Y A .50	
202620	96 1	COMP A-Z	B .50	221115	96 2	INDST COMP A .50	
----- GRADE 11 -----		97	98	SCHOOL YEAR -----*			
051400	H 97 1	WLDST/COMP	B .50	051400	V 97 2	WLDST/COMP B .50	
060240	F 97 1	GERM 301-Y	B .50	060240	F 97 2	GERM 302 B .50	
110710	M 97 1	TRG/MATHAN	C .50	110710	M 97 2	TRG/MATHAN B .50	
130500	S 97 1	ACCEL CHEM	C .50	130500	S 97 2	ACCEL CHEM D .50	
151400	W 97 1	WLD HIST	B .50	151400	W 97 2	WLD HIST B .50	
221115	97 1	INDSTNET	A .50				

----- CREDIT NEEDS SUMMARY -----

AREA	REQUIRED	EARNED	NEEDS	SCHEDULED
BASIC ECONOMICS	.25		.25	.25
STATE & LOCAL GOVT	.25		.25	.25
TOTAL ENGLISH	4.00	3.00	1.00	.50
GENERAL/ACADEMIC ELECTIVE	10.50	7.50	3.00	1.50
*** TOTAL CREDITS	22.00	17.50	4.50	2.50

* ALL EARNED CREDITS ARE INCLUDED IN THE TOTAL; ONLY THE NEEDS ARE ITEMIZED.

----- ENROLLMENT HISTORY -----

ENTERED	SCHOOL	WITHDREW	REASON
8/16/93	0 KEN CARYL MIDDLE SCHOOL	5/31/95	02 TRANSFER WITHIN DISTRICT
8/14/95	2 COLUMBINE SENIOR HIGH		CURRENTLY ENROLLED

JEFFERSON COUNTY PUBLIC SCHOOLS

TONELLI

SECONDARY SCHOOL REPORT CARD

11/06/98

STUDENT: 777592

PRINCIPAL: MR FRANK DE ANGELIS

NAME: HARRIS ERIC DAVID

GRADE: 12

SCHOOL: COLUMBINE SENIOR HIGH

COURSE TITLE	PERIOD	INSTRUCTOR	ABSENCES	COURSE GRADES			FIN	CREDIT
				T	T	T		
-----				1	2	3	-----	-----
VIDEO	01	TALOCCO						B+
GOV/ECON	02	TONELLI						B
POSITIVE ATTITUDE AND GOOD COOPERATION								
TM SPTSCOM	03	PLACE						A
GERM 401	04	BURNETT						B
CCB/MJBRWR	05	WEBB						B-

12 WEEK GRADES ARE IN-PROGRESS GRADES.
FINAL EXAMS FOR 1ST SEMESTER ARE DECEMBER 16 AND 17.
FINAL MAKE-UP DAY IS DECEMBER 18TH.

TO THE PARENTS OF
HARRIS ERIC DAVID

JC-001-026317

LITTLETON CO. 80128

JEFFERSON COUNTY PUBLIC SCHOOLS

TONELLI

SECONDARY SCHOOL REPORT CARD

09/23/98

STUDENT: 777592

PRINCIPAL: MR FRANK DE ANGELIS

NAME: HARRIS ERIC DAVID

GRADE: 12

SCHOOL: COLUMBINE SENIOR HIGH

COURSE TITLE	PERIOD	INSTRUCTOR	ABSENCES	COURSE GRADES			FIN	CREDIT
				T	T	T		
				1	2	3		
VIDEO	01	TALOCCO						
GOV/ECON POSITIVE ATTITUDE AND GOOD COOPERATION	02	TONELLI						
TM SPTSCOM	03	PLACE						
GERM 401	04	BURNETT						
CCB/MJBRWR	05	WEBB						

C - log

B+ 89.6% 7/30/98

PLEASE COME TO PARENT-TEACHER CONFERENCES ON TUESDAY, OCTOBER 13 OR WEDNESDAY, OCTOBER 14 FROM 5:00PM TO 8:15PM.

TO THE PARENTS OF
HARRIS ERIC DAVID
[REDACTED]
LITTLETON CO. 80128

JC-001-026318

JEFFERSON COUNTY PUBLIC SCHOOLS ^{TALOCCO}

SECONDARY SCHOOL REPORT CARD

02/19/99

STUDENT: 777592
 NAME: HARRIS ERIC DAVID
 SCHOOL: COLUMBINE SENIOR HIGH

PRINCIPAL: MR FRANK DE ANGELIS
 GRADE: 12

COURSE TITLE	PERIOD	INSTRUCTOR	ABSENCES	COURSE GRADES			FIN	CREDIT
				T 4	T 5	T 6		
BOWLING	01	MACAULEY		A				
ADV VIDEO	02	TALOCCO		A				
PHILOSOPHY	03	KRITZER		B				
CONLIT/CRT	04	KELLY	1	A-				
PSYCHOL	05	JOHNSON TJ		A				

6 WEEK GRADES ARE IN-PROGRESS GRADES. PLEASE COME TO PARENT-TEACHER CONFERENCES ON THURSDAY MARCH 11, 400 - 815 PM. NO SCHCCL ON MARCH 12. SPRING BREAK MARCH 15-19

TO THE PARENTS OF
 HARRIS ERIC DAVID

JC-001-026319

LITTLETON CO. 80128

JEFFERSON COUNTY PUBLIC SCHOOLS

MILLER T

SECONDARY SCHOOL REPORT CARD

04/17/98

STUDENT 777592 PRINCIPAL MR FRANK DE ANGELIS
 NAME HARRIS ERIC DAVID GRADE 11
 SCHOOL COLUMBINE SENIOR HIGH

COURSE TITLE	PERIOD	INSTRUCTOR	ABSENCES	COURSE GRADES			FIN	CREDIT
				T 4	T 5	T 6		
TRG/MATHAN	01	ROCKWELL	2		B			
ACCEL CHEM	02	MILLER T	2		C+		<i>78% other</i>	
GERM 302	03	BURNETT	3		B			
WLD HIST CLASS WORK IS IMPROVING	04	KRITZER	3		C+		<i>81% 4/22/98</i>	
WLDST/COMP	05	WEBB	2		B+			

6-WEEK GRADES ARE IN-PROGRESS GRADES.
 GRADUATION IS AT FIDDLER'S GREEN ON MAY 23 AT 1000 A.M.

TO THE PARENTS OF
 HARRIS ERIC DAVID
 [REDACTED]
 LITTLETON CO. 80128

JC-001-026320

ERIC HARRIS
MATH ANALYSIS / TRIGONOMETRY
FIRST HOUR

Below is a listing of the assignments you have received thus far in this grading period and the scores you earned for each. If your records differ in any respect, please see me privately as soon as possible.

ASSIGNMENT TITLES	YOUR SCORES	POINTS POSSIBLE	%
1. EXTRA CREDIT	0	0	N/A
2. QUIZ 6.1-6.2 [01/18]	19	20	95.0
3. QUIZ 6.1-6.3 [01/27]	13	20	65.0
4. CLASS GRADE WEEKS 1 - 3 [01/23]	13	13	100.0
5. CHAPTER 6 TEST [01/28]	81	100	81.0
6. ASSIGNMENTS #1 - 13 [01/29]	23	26	88.4
7. CLASS GRADE WEEK #4 [01/30]	5	5	100.0
8. CLASS GRADE WEEK #5 [02/06]	5	5	100.0
9. LAW OF SINES & COSINES [02/09]	24	25	96.0
10. CLASS GRADE WEEK #6 [02/13]	4	4	100.0
11. CLASS GRADE WEEK#7 [02/20]	4	4	100.0
12. ASSIGNMENTS #14 - 28 [02/27]	26	28	92.8
13. CHAPTER 87 TEST [02/27]	88	100	88.0
14. CLASS GRADE WEEK #8 [03/06]	5	5	100.0
15. QUIZ 8.1-8.2 [03/10]	17	20	85.0
	====	====	=====
TOTALS AND AVERAGES ----->	327	375	87.1

As of this date you have received 87.20% of the available points, and your grade is a B. If your figures vary significantly, see me.

Eric Harris
Accelerated Chemistry
Period 2

Below is a listing of the assignments you have received thus far in this grading period and the scores you earned for each. If your records differ in any respect, please see me privately as soon as possible.

CATEGORY: HOMEWORK/ HW QUIZZES
(15.0% of Cumulative Grade)

ASSIGNMENT TITLES	YOUR SCORES	POINTS POSSIBLE	%=LETTER GRADES
1. HW: Unit WS (Chap 9,10)	25	25	100.0=A
5. HW: CH 11 Phases of Matter	25	25	100.0=A
8. HW: Boyle's/ Charles Law	15	15	100.0=A
12. HW: Chap 12	15	15	100.0=A
	====	====	=====
CATEGORY SUMMARY ---->	80	80	100.0=A

CATEGORY: LAB REPORTS/ QUIZZES
(25.0% of Cumulative Grade)

2. Lab: Chem Reaction	25	30	83.3=B
4. LAB: Freezing Point and Heat of Fusion	20	25	80.0=B
7. Lab: Boyle's Law	15	15	100.0=A
9. Molar Volume of a Gas	13	15	86.6=B
10. LAB: Rates Of Diffusion	10	10	100.0=A
13. Lab: Relative Temp and Sol	19	20	95.0=A
14. Lab: Paper towels	15	0	N/A
	====	====	=====
CATEGORY SUMMARY ---->	117	115	101.7=A

CATEGORY: TEST AND QUIZZES
(60.0% of Cumulative Grade)

3. Test: Chap 9,10	35	52	67.3=D
6. T/Q: CH 11 Phases of Matter	38	50	76.0=C
11. Test: Chap 12	28	50	56.0=F
15. Test: Chap 16	45	51	88.2=B
	====	====	=====
CATEGORY SUMMARY ---->	146	203	71.9=C
TOTALS AND AVERAGES ---->	N/A	N/A	83.5=B

As of this date you have received 83.58% of the "weighted grade," and your grade is a B. If your figures vary significantly, see me.

FERSON COUNTY PUBLIC SCHOOLS

SECONDARY SCHOOL REPORT CARD

12/19/97

7592
 HARRIS ERIC DAVID
 COLUMBINE SENIOR HIGH

PRINCIPAL MR FRANK DE ANGELIS
 GRADE 11

00L

TITLE	PERIOD	INSTRUCTOR	ABSENCES	COURSE GRADES			FIN	CREDIT
				T 1	T 2	T 3		
STNET	00	LONG				A	A	0.500
LG/MATHAN	01	ROCKWELL	3			C	C	0.500
ACCEL CHEM	02	MILLER T	4			C	C	0.500
POSITIVE ATTITUDE AND GOOD COOPERATION IMPROVED EFFORT WILL RAISE GRADE								
GERM 301-Y	03	BURNETT	3			B-	B-	0.500
WLDST/COMP	04	WEBB	2			B	B	0.500
WLD HIST	07	FLEENER	4			B	B	0.500

WISHING YOU A HAPPY AND HEALTHY NEW YEAR
 WELCOME BACK

TO THE PARENTS OF
 HARRIS ERIC DAVID

JC-001-026323

LITTLETON CO. 80128

JEFFERSON COUNTY PUBLIC SCHOOLS

MILLER T

SECONDARY SCHOOL REPORT CARD

11/14/97

STUDENT: 777592

PRINCIPAL: MR FRANK DE ANGELIS

NAME: HARRIS ERIC DAVID

GRADE: 11

SCHOOL: COLUMBINE SENIOR HIGH

COURSE TITLE	PERIOD	INSTRUCTOR	ABSENCES	COURSE GRADES			FIN	CREDIT
				T 1	T 2	T 3		
INDSTNET	00	LONG						A
TRG/MATHAN	01	ROCKWELL	3					C
ACCEL CHEM	02	MILLER T	3					C
GERM 301-Y	03	BURNETT	3					B
WLDST/COMP	04	WEBB	2					B
WLD HIST	07	FLEENER	4					B+

12 WEEK GRADES ARE IN-PROGRESS GRADES.
 FINAL EXAMS FOR FIRST SEMESTER ARE DECEMBER 17 AND 18.
 FINAL MAKE UP DAY IS DECEMBER 19.

TO THE PARENTS OF
 HARRIS ERIC DAVID

JC-001-026324

LITTLETON CO. 80128

JEFFERSON COUNTY PUBLIC SCHOOLS

SECONDARY SCHOOL REPORT CARD

05/30/9

STUDENT: 777592

PRINCIPAL: MR FRANK DE ANGELIS

NAME: Harris Eric

GRADE: 10

SCHOOL: COLUMBINE SENIOR HIGH

COURSE TITLE	PERIOD	INSTRUCTOR	ABSENCES	COURSE GRADES			FIN	CREDI
				T 4	T 5	T 6		
AMER LIT/C Positive Attitude And Good Cooperation Strong Interest And Participation	01	CARUTHERS				A	A	0.50
AM HIST -Y	02	HAYES E				A	A	0.50
INDST COMP	03	LONG				A	A	0.50
ALGEBRII-Y	04	SMITH, D.	1			A	A	0.50
BIO I -Y	05	MILLER T				B	B	0.50
GERM 202-Y	06	BURNETT	1			B	B	0.50

HAVE A FUN-FILLED SUMMER!

TO THE PARENTS OF
Harris Eric

Littleton CO. 80123

JC-001-026325

JEFFERSON COUNTY PUBLIC SCHOOLS

MILLER T

SECONDARY SCHOOL REPORT CARD

10/03/97

STUDENT 777592 PRINCIPAL MR FRANK DE ANGELIS
NAME HARRIS ERIC GRADE 11
SCHOOL COLUMBINE SENIOR HIGH

COURSE TITLE	PERIOD	INSTRUCTOR	ABSENCES	COURSE GRADES			FIN	CREDIT
				T	T	T		
INDSTNET	00	LONG						N
TRG/MATHAN	01	ROCKWELL	1					C
ACCEL CHEM	02	MILLER T	1					C
GERM 301-Y	03	BURNETT	1					B
WLDST/COMP	04	WEBB	1					B
WLD HIST	07	FLEENER	2					B+

PLEASE COME TO PARENT-TEACHER CONFERENCES ON TUESDAY, OCT 14 OR WEDNESDAY, OCT 15 FROM 5-815 PM.

TO THE PARENTS OF
HARRIS ERIC

JC-001-026326

LITTLETON CO. 80128

Eric Harris
Accel Chemistry
Period 2

145
free
hw.
afterschool

Below is a listing of the assignments you have received thus far in this grading period and the scores you earned for each. If your records differ in any respect, please see me privately as soon as possible.

CATEGORY: HOMEWORK
(15.0 % of Cumulative Grade)

ASSIGNMENT TITLES	YOUR SCORES	POINTS POSSIBLE	%=LETTER GRADES
3. HW: Quiz 1 (C1 and pg 19)	8	10	80.0=B
5. HW: Quiz 2 (C2 10-24)	9	10	90.0=A
6. HW: Quiz 3 (C2 25-35)	4	6	66.6=D -
7. HW: Algebraic EQ WS	5	9	55.5=F -
12. HW: Quiz 4 (C4 prob 1-9)	5	5	100.0=A
13. HW (C4 prob 10-27)	7	12	58.3=F -
19. HW: Quiz 5 (Chap 6)	15	15	100.0=A
CATEGORY SUMMARY ---->	53	67	79.1=C

CATEGORY: LAB AND LAB QUIZZES
(25.0 % of Cumulative Grade)

2. Lab: Bonus points	0	0	N/A
8. Lab: Intro Activity	9	10	90.0=A
9. LAB: Lab Skills	34	45	75.5=C
14. Lab: Mass to volume	13	20	65.0=D
15. Lab: Chem and Phy changes	16	20	80.0=B
16. Lab: Law of Conservation	15	15	100.0=A
18. Lab: Isotopes	15	15	100.0=A
CATEGORY SUMMARY ---->	102	125	81.6=B

CATEGORY: TESTS AND QUIZZES
(60.0 % of Cumulative Grade)

4. QZ: Elements	17	20	85.0=B
10. TST; Unit I	41	56	73.2=C
11. QZ: Chap 3 (Dimensional Analysis)	27	44	61.3=D
17. Tst: Unit II	75	96	78.1=C
20. TST: Chapter 6	38	64	59.3=F -
CATEGORY SUMMARY ---->	198	280	70.7=C
TOTALS AND AVERAGES ---->	N/A	N/A	74.6=C

As of this date you have received 74.69% of the "weighted grade," and your grade is a C. If your figures vary significantly, see me.

JC-001-026327

Doesn't apply

unrevised / no credit
absent

JEFFERSON COUNTY PUBLIC SCHOOLS

STUDENT 777502

STUDENT TRANSCRIPT ON 06/04/97

THRU GRADE 11

HARRIS ERIC

GPA 3.583

COLUMBINE SENIOR HIGH

RANK 104 / 435

6201 SO PIERCE ST

LITTLETON CO. 80123

ON 6/4/97

LITTLETON CO. 80123

SSN [REDACTED]

TOTAL CREDITS 12.00

PARENTS/GUARDIANS

BIRTH 4/9/81

ACADEMIC CRED 9.50

KATHY HARRIS
WAYNE HARRIS

* ----- SEMESTER 1 ----- *

* ----- SEMESTER 2 ----- *

----- GRADE 09 -----				*----- GRADE 10 -----*				*----- GRADE 09 -----*				*----- GRADE 10 -----*										
050031	H	95	1	9	LANGARTS	A	.50	030100	95	2	KEYBD 1	A	.50	050031	V	95	2	9	LANGARTS	A	.50	
060220	F	95	1	GERM 101-Y	A	.50		060220	F	95	2	GERM 101-Y	B	.50	060610	Q	95	2	TM SPRT/CO	A	.50	
103320		95	1	WOOD	A	.50		110531	M	95	2	GEOMETRY 9	B	.50	130300	S	95	2	EARTH SC-Y	A	.50	
110531	M	95	1	GEOMETRY 9	A	.50		130300	S	95	2	EARTH SC-Y	A	.50								
130300	S	95	1	EARTH SC-Y	A	.50																
150300	D	95	1	A4 GOVT	A	.50																
----- GRADE 09 -----				*----- GRADE 10 -----*				*----- GRADE 09 -----*				*----- GRADE 10 -----*										
051011	H	96	1	AMER LIT/C	B	.50		051011	V	96	2	AMER LIT/C	A	.50	051011	V	96	2	AMER LIT/C	A	.50	
060230	F	96	1	GERM 201-Y	B	.50		060230	F	96	2	GERM 202-Y	B	.50	060230	F	96	2	GERM 202-Y	B	.50	
110600	M	96	1	ALGEBRII-Y	B	.50		110600	M	96	2	ALGEBRII-Y	A	.50	110600	M	96	2	ALGEBRII-Y	A	.50	
130400	S	96	1	BIO I -Y	B	.50		130400	S	96	2	BIO I -Y	B	.50	130400	S	96	2	BIO I -Y	B	.50	
151200	A	96	1	AM HIST -Y	B	.50		151200	A	96	2	AM HIST -Y	A	.50	151200	A	96	2	AM HIST -Y	A	.50	
202620		96	1	COMP A-Z	B	.50		221115		96	2	INDST COMP	A	.50	221115		96	2	INDST COMP	A	.50	

----- CREDIT NEEDS SUMMARY -----

AREA	REQUIRED	EARNED	NEEDS	SCHEDULED
WORLD HISTORY	1.00		1.00	.50
BASIC ECONOMICS	.25		.25	
STATE & LOCAL GOVT	.25		.25	
CORE ENGLISH	3.00	2.00	1.00	.50
ENGLISH ELECTIVE	1.00		1.00	
GENERAL/ACADEMIC ELECTIVE	10.50	4.00	6.50	2.00

*** TOTAL CREDITS 22.00 12.00 10.00 3.00

* ALL EARNED CREDITS ARE INCLUDED IN THE TOTAL ONLY THE NEEDS ARE ITEMIZED.

----- ENROLLMENT HISTORY -----

ENTERED	SCHOOL	WITHDREW	REASON
8/16/93	0 KEN CARYL MIDDLE SCHOOL	5/31/95	02 TRANSFER WITHIN DISTRICT
8/14/95	2 COLUMBINE SENIOR HIGH		CURRENTLY ENROLLED

JEFFERSON COUNTY PUBLIC SCHOOLS

SECONDARY SCHOOL REPORT CARD

04/18/97

STUDENT 777592 PRINCIPAL MR FRANK DE ANGELIS
 NAME HARRIS ERIC GRADE 10
 SCHOOL COLUMBINE SENIOR HIGH

COURSE TITLE	PERIOD	INSTRUCTOR	ABSENCES	COURSE GRADES			FIN	CREDIT
				T	T	T		
				4	5	6		
AMER LIT/C POSITIVE ATTITUDE AND GOOD COOPERATION CLASS WORK IS IMPROVING	01	CAROTHERS						A
AM HIST -Y	02	HAYES E						A
INDST COMP	03	LONG						A
ALGEBRII-Y	04	SMITH, D.	1					B
BIO I -Y	05	MILLER T						C
GERM 202-Y POSITIVE ATTITUDE AND GOOD COOPERATION	06	BURNETT						B-

TO THE PARENTS OF
 HARRIS ERIC

 LITTLETON CO. 80123

JC-001-026329

Eric Harris
Biology 1
Period 5

Below is a listing of the assignments you have received thus far in this grading period and the scores you earned for each. If your records differ in any respect, please see me privately as soon as possible.

ASSIGNMENT TITLES	YOUR SCORES	POINTS POSSIBLE	%=LETTER GRADES
1. HW: Signed Policy Sheet	10	10	100.0=A
2. Lab: Biochemical Evidence for Evolution	15	15	100.0=A
3. HW: RG pgs 291-313	1	15	6.6=F
4. HW Quiz: OL pgs 283-285	14	15	93.3=A
5. Lab: Variation within a Population	19	20	95.0=A
6. Lab: Natural Selection	19	20	95.0=A
7. HW: Outlines pgs 296-302	8	10	80.0=B
8. HW: Evolution Review	✓	✓	N/A
9. Exam: Evolution	103	140	73.5=C
10. Grp: Concept Map	23	30	76.6=C
11. Lab: Classification	9	10	90.0=A
12. HW: Classification WS	14	15	93.3=A
13. HW: Classification Review	10	10	100.0=A
14. Lab: Biological Key	13	16	81.2=B
15. Exam: Classification	93	100	93.0=A
16. Lab: Virus Replication	10	10	100.0=A
17. Lab: Cyanobacteria	19	20	95.0=A
18. BNS: Virus and Monera	4	0	N/A
19. Lab: Culturing Eubacteria	18	20	90.0=A
20. HW: Chap 18 RG	20	20	100.0=A
21. Lab: Protist	18	20	90.0=A
22. Lab: Fungi	22	25	88.0=B
23. HW: Chap 17 OL	20	20	100.0=A
24. Exam: Lower Organisms	65	100	65.0=D
25. QZ: Vocab Invert I	2	20	10.0=F
	=====	=====	=====
TOTALS AND AVERAGES ---->	549	681	80.6=B

ABBREVIATIONS:

65%⁹⁷

✓ = CREDIT (with no point value)

As of this date you have received 80.61% of the available points, and your grade is a B. If your figures vary significantly, see me.

JEFFERSON COUNTY PUBLIC SCHOOLS

MILLER T

SECONDARY SCHOOL REPORT CARD

10/04/9

STUDENT 777592 PRINCIPAL MR FRANK DE ANGELIS
 NAME HARRIS ERIC GRADE 10
 SCHOOL COLUMBINE SENIOR HIGH

COURSE TITLE	PERIOD	INSTRUCTOR	ABSENCES	COURSE GRADES			FIN	CREDI
				T	T	T		
				1	2	3		
✓ ALGEBR II-Y	01	HAVENS						B
BIO I -Y POSITIVE ATTITUDE AND GOOD COOPERATION	02	MILLER T						A <i>Steps</i>
✓ COMP A-Z	03	STRAND						B+
✓ AMER LIT/C	04	ABBOTT						C
✓ GERM 201-Y STRONG INTEREST AND PARTICIPATION	06	BURNETT						B- <i>Dictionary list - vocab</i>
AM HIST -Y	07	MATHIS						B

PLEASE COME TO PARENT-TEACHER CONFERENCES ON WEDNESDAY OCT 9 OR THURSDAY, OCT 10 FROM 5-815 P.M.

TO THE PARENTS OF
 HARRIS ERIC

[REDACTED]
 LITTLETON CO. 80123

JC-001-026331

JEFFERSON COUNTY PUBLIC SCHOOLS

SECONDARY SCHOOL REPORT CARD

11/15/96

STUDENT 777592 PRINCIPAL MR FRANK DE ANGELIS
 NAME HARRIS ERIC GRADE 10
 SCHOOL COLUMBINE SENIOR HIGH

COURSE TITLE	PERIOD	INSTRUCTOR	ABSENCES	COURSE GRADES			FIN	CREDIT
				T	T	T		
				1	2	3		
ALGEBRII-Y	01	HAVENS						B
BIO I -Y POSITIVE ATTITUDE AND GOOD COOPERATION	02	MILLER T						B
CDMP A-Z	03	STRAND						A
AMER LIT/C	04	ABBOTT						B
GERM 201-Y	06	BURNETT						B-
AM HIST -Y	07	MATHIS	1					B

GRADE SHOWN IS THE 12-WEEK CUMULATIVE GRADE.

TO THE PARENTS OF
 HARRIS ERIC

LITTLETON CO. 80123

JC-001-026332

JEFFERSON COUNTY PUBLIC SCHOOLS

SECONDARY SCHOOL REPORT CARD

02/21/97

STUDENT 777592 PRINCIPAL MR FRANK DE ANGELIS
 NAME HARRIS ERIC GRADE 10
 SCHOOL COLUMBINE SENIOR HIGH

COURSE TITLE	PERIOD	INSTRUCTOR	ABSENCES	COURSE GRADES			FIN	CREDIT
				T	T	T		
				4	5	6		
AMER LIT/C POSITIVE ATTITUDE AND GOOD COOPERATION	01	CARUTHERS						B
AM HIST -Y	02	HAYES E						A
INDST COMP	03	LONG						A
ALGEBRII-Y	04	SMITH, D.	1					B
BIO I -Y	05	MILLER T						B
GERM 202-Y	06	BURNETT						B

YOU ARE CORDIALLY INVITED TO PARENT-TEACHER CONFERENCES ON THURSDAY, MARCH 13, 4-815 P.M.

TO THE PARENTS OF
 HARRIS ERIC



JC-001-026333

LITTLETON CO. 80123

JEFFERSON COUNTY PUBLIC SCHOOLS ^{TALOCCO}

SECONDARY SCHOOL REPORT CARD

04/C9/99

STUDENT: 777592
 NAME: HARRIS ERIC DAVID
 SCHOOL: COLUMBINE SENIOR HIGH

PRINCIPAL: MR FRANK DE ANGELIS
 GRADE: 12

COURSE TITLE	PERIOD	INSTRUCTOR	ABSENCES	COURSE GRADES			FIN	CREDIT
				4	5	6		
BOWLING	01	MACAULEY	1	A	A			
ADV VIDEO	02	TALOCCO	1	A	B+			
IMPROVED EFFORT WILL RAISE GRADE NOT WORKING TO FULL POTENTIAL								
PHILOSOPHY	03	KRITZER		B	C			
CONLIT/CRT	04	KELLY	3	A-	B			
PSYCHOL	05	JOHNSON TJ		A	A			

12 WEEK GRADES ARE IN PROGRESS GRADES.
 GRADUATION IS AT FIDDLER'S GREEN ON MAY 22 AT 1000 A.M.

TO THE PARENTS OF
 HARRIS ERIC DAVID



JC-001-026334

LITTLETON CO. 80128

603

99-7625

042099

JEFFERSON COUNTY SHERIFF

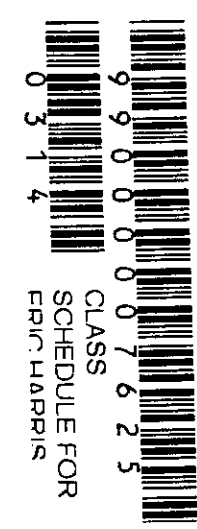

COLUMBINE SENIOR HIGH
HARRIS ERIC DAVID
777592 *** STUDENT SCHEDULE ***

03/04/99
SEMESTER C

COURSE DESCRIPTION	S E M E S T E R	PERIODS		DAYS MET	ROOM NO.	INSTRUCTOR	FOR OFFICE USE ONLY			
		FROM	TO				COURSE	SECT.	INST.	FEE
EDMUND	C	01	01	MTWRF	PE	MACAULLEY	083501	0001	0806	.
ADV VIDEO	C	02	02	MTWRF	TECH	TALUCCO	104450	0002	1020	.
PHILOSOPHY	C	03	03	MTWRF	SS-7	KRITZER	151800	0001	1570	.
CUNLIT/CRT	C	04	04	MTWRF	LA-2	KELLY	051074	0001	0546	.
PSYCHOL	C	05	05	MTWRF	SS-4	JOHNSON TJ	151700	0004	1543	.

99-7625

99-7625 4-20-99

COLUMBINE HIGH SCHOOL OFFICE REFERRAL

STUDENT Eric Harris GRADE 11

DATE 10/2 PERIOD 3 REFERRED BY _____

REASON FOR REFERRAL After obtaining confidential information Eric broke into students lockers.

TEACHER ACTION TAKEN PRIOR TO THIS REFERRAL

- ____ Student given verbal warning in class on _____
- ____ Held a conference with the student on _____
- ____ Had the student serve detention(s) on _____
- ____ Contacted parent/guardian on _____
- ____ Held a conference with parent/guardian on _____
- ____ Teacher consulted with counselor/adm on _____
- ____ Other _____

ADMINISTRATIVE ACTION TAKEN

- Conference held with Student Counselor Parent Teacher _____
- Date of parent contact 10/2 Time 11:30am # 783-3190
- ____ In-school suspension dates _____
- Dates of student suspension 3 day suspension 10/3 10/6 10/7
- ____ Other _____

REMARKS May Re-enter school on Wednesday October 8th
Eric can not be on school campus or at any
school activities during the time of his suspension

Administrator Signature Peter A. Horvath 10-2-97
8/8/96connelly

10/3 - called Mr. Horvath
What will be on Eric's records? In-house only because Police were not involved. Restrained upon graduation.

JC-001-026336

603 529112 412099

JEFFERSON COUNTY SHERIFF
 CLASS SCHEDULE FOR
 ERIC HARRIS
 9 9 0 0 0 0 0 7 6 2 5
 0 3 1 4

COLUMBINE SENIOR HIGH
 HARRIS ERIC DAVID
 *** STUDENT SCHEDULE ***
 777592 H 12

JC-001-026337

COURSE DESCRIPTION	S E M	PERIODS		DAYS MET	ROOM NO.	INSTRUCTOR	FOR OFFICE USE ONLY			
		FROM	TO				COURSE	SECT.	INST.	FEE
ENGLISH	C		01-01	MTWRF	PE	MACAULEY	080501	0001	0806	..
ADV VIDEO	C		02-02	MTWRF	TECH	TALUCCO	194450	0002	1020	..
PHILOSOPHY	C		03-03	MTWRF	SS-7	KRITZER	151800	0001	1570	..
COUNLIT/CRT	C		04-04	MTWRF	LA-8	KELLY	053075	0001	0546	..
PSYCHOL	C		05-05	MTWRF	SS-4	JOHNSON TJ	151200	0001	1570	..

902 JRH 99-7625 42099

JEFFERSON COUNTY PUBLIC SCHOOLS

TALOCCO

35

SECONDARY SCHOOL REPORT CARD

04/09/99

STUDENT: 777592
 NAME: HARRIS ERIC DAVID
 S JOL: COLUMBINE SENIOR HIGH

PRINCIPAL: MR FRANK DE ANGELIS
 GRADE: 12

COURSE TITLE	PERIOD	INSTRUCTOR	ABSENCES	COURSE GRADES			FIN	CREDIT
				I	T	T		
				4	5	6		
BOWLING	01	MACAULEY	1	A	A			
ADV VIDEO	02	TALOCCO	1	A	B+			
IMPROVED EFFORT WILL RAISE GRADE NOT WORKING TO FULL POTENTIAL								
PHILOSOPHY	03	KRITZER		B	C			
CONLIT/CRT	04	KELLY	3	A-	B			
PSYCHOL	05	JOHNSON TJ		A	A			

12 WEEK GRADES ARE IN PROGRESS GRADES.
 GRADUATION IS AT FIDDLER'S GREEN ON MAY 22 AT 1000 A.M.

TO THE PARENTS OF
 HARRIS ERIC DAVID

LITTLETON CO. 80128

JC-001-026338

60-80 people scattered

10:30-10:50

10:56-10:58 lunch ladies
Bring out shift

Lunch door 2 opens

10:55-11:05=100-120

11:04-11:06=140-180

11:07-11:08=200-220

steady trickle of people

11:08-#3 door opens

9-#1 door opens

11:09-250-270

11:10-270-300

heavy additions

11:11 lines start

11:11:30-12 300-350

11:12-11:13=350-450

11:14-11:15=500+

>>>>>All Code Pointers in Doom v1.9<<<<<<
<<<<<Figured out by Andy Shawaluk>>>>>

Additions by:

Francesco Orsenigo (159, 184, 788)
"Shadow Lord" (282, 397, 774)
Jjukil (257, 264, 282, 603, 635, 676, 718)

Notes:

Each code pointer is listed only once. The two "check line of sight" pointers are different, but with the same effect. Only one pointer has a function unknown to me. All pointers which make sounds ONLY can be used anywhere, but they may not always work. Weapon code pointers are restricted to the weapon frames, and the monster code pointers are used anywhere else. For the Mancubus firing pointers, the directions are as viewed from the mancubus, so a "left" fireball will go past you to the right if you do not move. That should clear things up.

Weapon Code Pointers:

- 1 - Light restore (after flash)
- 2 - Weapon bobbing pointer
- 3 - Weapon select pointer
- 4 - Weapon deselect pointer
- 6 - Player Punch
- 9 - Last shooting frame (if fire button still held, jump back to first shooting frame instead of frame with this pointer)
- 14 - Player Pistol shot
- 17 - Light flash (dim)
- 22 - Player Shotgun blast
- 31 - Light flash (bright)
- 36 - Player Double-Barrel Shotgun blast
- 38 - Check ammo (If 1 or 0 shells left, skip reloading frames and select different weapon)
- 39 - Play sound "dbopn"
- 41 - Play sound "dbload"
- 43 - Play sound "dbcls"
- 52 - Player Chaingun shot (check ammo; don't go to -1 ammo, change weapon)
- 60 - Display firing frame
- 61 - Player launch rocket
- 71 - Player use chainsaw
- 77 - Player fire plasma bullet
- 84 - Play sound "bfg"
- 86 - Player fire BFG shot

Monster Code Pointers:

- 119 - BFG blast effect
- 127 - Radius explosion~~2801~~
- 157 - Play pain sound
- 159 - Plays "PLDETH"
- 160 - Dead body mode
- 166 - Play sound "slop"
- 174 - Wait to wake up
- 176 - Standard walking code pointer
- 184 - Turn to face the player's direction
- 185 - Trooper pistol shot
- 190 - Play death sound
- 243 - Archvile walking code pointer (check to resurrect monster)
- 255 - Play sound "vilatk"
- 257 - Create archvile flame at target, enable radius explosion for #264
- 264 - Target jumps in air, takes 10%-20% damage
- 281 - Play sound "flamest"

ORIGINAL

THE SHIT LIST

[REDACTED]

[REDACTED]

It would be great if god removed all vaccines and warning lables from everything in the world and let natural selection take its course. All the fat ugly retarded crippled dumbass stupid fuckheads in the world would die, and oh fucking well if a few of the good guys die to. Maybe then the human race can actually be proud of itself. World war II is the last time I bet America was proud of its self. We beat the fuck out of the damn zipperheads and the nazis. We came back, from being bombed and loosing major battles to nuke that little piece of shit island and to take over that cool place called Deustchland. I say its cool because I love the German language and "BRUTE" stuff. Kein mitleid fur die merheit. Put everyone in doom I and see who can get past atleast level 1. Actually, then put them into MY worlds. Like Thrasher, Whiskey, UAC Labs, und TIER. I would love to see all you fuckheads die. NBK. I love it! sometime in april me and V will get revenge and will kick natural selection up a few notches. Armed with the following; a terroist bag full of noisey crickets, noisey crickets strapped to WD40 cans, pipe bombs with a shit load of shrapnel, fire bombs, chlorine gas bombs, and smoke bombs. Fire arms we arent sure of yet, hopefully V will have his #3 and plenty of ammo for it. thats another thing, ill fuck around with some shotgun shells for more bombs also. For me, I don't know what weapon ill have. I just want a firearm that can hold lots of bullets and that wont jam on me. So ill need lots of clips to. Ill have those strapped onto my chest. Maybe a bullet proof vest too. We will be in all black. Dusters, black army pants, and we will get custom shirts that say R or V in the background in one big letter and NBK in the front in a smaller font. We will have knives and blades and backup weaponry all over our bodies, I will have a tattoo of REB on my right arm. Once we start we will wear balaclavas. First we will go to the house of [redacted] and [redacted] in the morning before school starts and before anyone is even awake. We go in, we silently kill each inhabitant and then pin down [redacted] and [redacted]. Then take our sweet time pissing on them, spitting on them, and just torturing the hell out of them. Once we are done there we set time bombs to burn the houses down and take any weaponry that we find, who knows we may get lucky. Then get totally prepared and during Alunch we go in and park in our spots. With sunglasses on we start carrying in all of our bags of terrorism and anarchism shit into our table. Being very casual and silent about it. its all for a science/band/english project or something. Then, we sit down, play some pumpup music, light a 50\$ stoge, and get ready to start throwing out the first wave of crickets. Then, we light them, and throw them as far as we can, once the first wave starts to go off and the chaos begins, V opens fire and I start lobin the firebombs. Then I open fire and V starts lobin more crickets. Then if we can we go upstairs and go to each classroom we can and pick off fuckers at our will. If we still can we will hijack some awesome car, and drive off to the neighborhood of our choice and start torching houses with molotov cocktails. by that time cops will be all over us and we start to kill them to!we use bombs, fire bombs, and anything we fucking can to kill and damage as much as we fucking can. if it comes to the time when we are trapped with absolutely no way out, we eat crickets along with a ton of chlorine or some other deadly gas. so when we die, so will anyone close to us. if we have figured out the art of time bombs before hand, we will set hundreds of them around houses, roads, bridges, buildings and gas stations. anything that will cause damage and chaos. if you have ever seen the first few clips of violence in INVASION USA youll know what im talkin about. itll be like the LA riots, the oklahoma bombing, WWII, vietnam, duke and doom all mixed together. maybe we will even start a little rebelion or revolution to fuck things up as much as we can. i want to leave a lasting impression on the world. and god damnit do not blame anyone else besides me and V for this. dont blame my family, they had no clue and there is nothing they could have done, they brought me up just fucking fine, dont blame toy stores or any other stores for selling us ammo, bomb materials or anything like that because its not their fault, i dont want no fucking laws on buying fucking PVC

pipes. we are kind of a select case here so dont think this will happen again. dont blame the school, dont fucking put cops all over the place just because we went on a killing spree doesnt mean everyone else will and hardly ever do people bring bombs or guns to school anyway, the admin. is doing a fine job as it is, i dont know who will be left after we kill but damnit dont change any policies just because of us. it would be stupid and if there is any way in this fucked up universe we can come back as ghosts or what the fuck ever we will haunt the life out of anyone who blames anyone besides me and V. if by some wierd as shit luck my and V survive and escape we will move to some island somewhere or maybe mexico, new zelend or some exotic place where americans cant get us. if there isnt such place, then we will hijack a hell of a lot of bombs and crash a plane into NYC with us inside iring away as we go down. just something to cause more devistation.

330

ORIGINAL

[REDACTED]



Jay Marcum Realty



Independent Companies
Working Together

Jay Marcum
Broker Owner

Direct: (303) 973-8130 Ext 202
Residence: (303) 979-1131
Mobile: (303) 915-9225

- 1. Dad's W. [REDACTED]
- 2. Mom's W. [REDACTED]
- 3. Kevin [REDACTED]
- 4. Karen [REDACTED]
- 5. Cindy [REDACTED]
- 6. Elaine [REDACTED]
- 7. Sandy [REDACTED]
- 8. Thelma [REDACTED]
- 9. Dylan/Tom [REDACTED]
- 10. Answering [REDACTED]

Sony IP910 Phone #

PGM #

PGM #

Sony #450 PGM

PGM #

Phone #

PGM

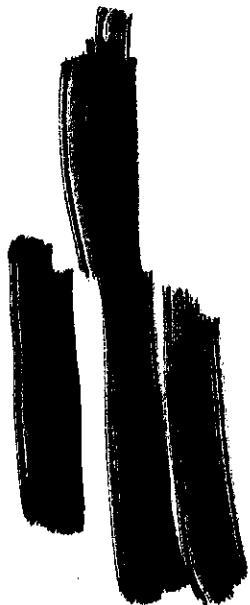

JC-001-026347

ed. 1
st. 1
p. 1

568983

[REDACTED]

729261

[REDACTED]

[REDACTED]

[REDACTED]



331

REBELS PHONETIC ALPHABET AND CODE SYSTEM

SURGE : ATTACK
SIGMA I-2-0: GET IN FORMATION
KNIGHTS. REBELS I-2-0: GET READY, GEARUP.
REVEREND BISHOP: SHOULD WE TELL HIM/THEM?
KNIGHT 3: DUNNO
KNIGHT 5: LIE, BULLSHIT HIM/THEM
RAMEREZ: THATS BULLSHIT, HES BULLSHITING US, BULLSHIT
FOX 3: FIRE I (BEGINNING OF A NUMBER OF LAUNCHES)
FOX 2: FIRE. LAUNCH. THROW, ETC.
FOXER: SOMETHING WENT WRONG, MALFUNCTION, FUCKED UP
ALPHA BRAVO: GET READY, ARM YOURSELF, LOCK N LOAD
BRAVO: DONT DO IT, SEIZE FIRE, STOP, DONT.
CHARLIE: TEACHER/S AROUND
CONTROL: LOOK OUT! ABOUT TO FIRE OR LAUNCH
DELTA5: INCOMING
ECHO: CLEAR
FOXTROT: RUN, LEAVE FAST, GET OUT (AS A SUGGESTION)
GAMMA: ARE YOU SERIOUS/SURE?
GAMMA NINER: CHECK AGAIN
HYPO: DOG, OR ANY OTHER NOISY ANIMAL
KAPPAI: FRESHMAN, ASSHOLES, FAGS, DICKHEADS NEAR BY
OMEGA: DIRECT HIT, PERFECT SHOT
NATO: LIGHTS, TURN ON THE LIGHTS, GIMME A LIGHT.
OTTO7: ON MY WAY, BE THERE SOON
TANGO THETA: GO 90 TO THE LEFT OF LAST COMMAND
WHISKY ROUGER: MOVE 90 TO THE RIGHT OF LAST COMMAND
GAINSAY PRIOR: ~~MOVE 180 FROM THE LAST COMMAND~~
BALLISTICS: WEAPONS (PAINTBALL GUNS, AIR GUNS, SLINGSHOTS, CROSSBOWS)
ZULU: CAR!
SHEPARD: COP, OR ANY OTHER AUTHORITY FIGURE
SHEPARD RECON: DO A CHECK FOR CARS, STUFF LIKE THAT
RAIL SECTOR: IM OUTA HERE, SIGNING OFF, LEAVING
TECHNO WEED: LIGHTS!
STELLER: BREAK OUT THE GOODS, HAND EM OUT, ETC.
PHOBOS RIM: WAR TIME, BEGIN BATTLE.
NINER: YEP
EPSO: CHICK, VERY HOT ONE.
EPSO 12: IN FRONT, ETC.
IOTA: CHANGE IN PLANS.
QUAKE LEVEL: FIREWORKS (GROUND STUFF)
HEXEN MAPS: FIREWORKS (AIREAL)
ADD-ON PATCH: FUSES
BIG SLIM JIM: CIGAR
SMALL SLIM JIM: CIGARETTE
~~THAT DISK: ZIPPAS~~
TASIATE: CASES (FOR LAPTOPS)
PROTRATE: LAPTOPS
CARBON: KNIVES, BLADES
SCHUTZER: RADIO OR COMMUNICATIONS (SAY # FOR CHANNEL #)
CROSSITRY: GOGGLES (BINOCULARS, NV, OR IR)
PHOENIX: ORDERS
ZEPHER: LASERS
FLUKER: MOTION SENSORS/TRACKERS
ETA: ESTIMATED TIME OF ARRIVAL
PA: POSTAL ARRIVAL

JC-001-026349

MATERIAL SPECIFICATIONS FOR "THE SPROCKET"

MATERIALS FOR CONSTRUCTION CAN BE OF ANY CODE APPROVED PIPING SYSTEM FOR EITHER POTABLE WATER, OR DRAIN, WASTE AND VENT. (INCLUDED BUT NOT LIMITED TO P.V.C., A.B.S., COPPER, BLACK IRON, GALVANIZED IRON, CAST IRON ETC...)

COMBUSTION CHAMBER LENGTH: COMBUSTION CHAMBER LENGTH SHOULD NOT EXCEED 12" IN OVERALL LENGTH. (FOR YOUR PROTECTION !!!)

BARRELL LENGTH: BARRELL LENGTH SHOULD BE NOT LESS THAN 24", NOR MORE THAN 30".

IGNITION DEVICE: ANY COMMON IGNITION DEVICE WILL WORK. THE MOST COMMONLY USED IGNITION DEVICE IS KNOWN AS A LANTERN LIGHTER, AS MADE BY COLEMAN. THIS DEVICE IS AVAILABLE FROM MOST ARMY/NAVY SURPLUS STORES. (HAMPDEN AND BROADWAY FOR SURE) THE USE OF ELECTRONIC IGNITION DEVICES IS CONSIDERED LEGAL.

PROPELLANT: PROPELLANT IS LIMITED TO THE USE OF HAIR SPRAYS WITH PROPANE BUTANE AND SD ALCAHOL CONTENTS. (NO STRAIGHT PROPANE, STRAIGHT ACETELYNE, MAPP GAS, GUN POWDER, ETC... AGAIN, THIS IS FOR YOUR PROTECTION !!!)

PROJECTILES: PROJECTILES ARE LIMITED TO POTATOES. THESE POTATOES CAN BE RED, WHITE OR BLUE. POTATOES CAN BE RAW OR COOKED (NOT RECOMMENDED). NO OTHER OBJECTS (I.E. ROCKS, BOLTS ETC..) SHALL BE USED !!!

RULES OF ENGAGEMENT

1.) NO DIRECT SHOTS SHALL BE ALLOWED TOWARD ANY PERSON, VEHICLE, CRAFT OR BODY. ALL SHOTS SHALL BE OF A "MORTAR LOB" TYPE SHOT, WHEREBY, THE SPROCKET IS POINTED UP, AND NOT MORE THAN 45 DEGREES FROM THE VERTICAL. THESE DEVICES ARE AND SHOULD BE CONSIDERED DANGEROUS. NUMEROUS INCA BOYS AND SOUTHSIDE HOMIES HAVE BEEN FOUND DEAD IN ALLEYS WITH MASHED POTATOES BETWEEN THEIR EYES... (45 DEGREE ANGLE EXCLUDES DISTANCE SHOOTING)

2.) TREAT EVERY SPROCKET AS IF IT WERE LOADED. (TREAT IT AS IF IT WERE A LOADED GUN !!!)

3.) THE FIRING OF SPROCKETS TOWARD ANY UNARMED OR UNLEGGED PEOPLE WILL BE CONSIDERED REASONS FOR DISMEMBERMENT, AND PERSON(S) COMMITTING SUCH ACT WILL BE PENALIZED ONE FINGER OR OTHER APPENDAGE FOR EACH INFRACTION OF DIS RULE. (TO BE ENFORCED BY "THE THREE BIG BASS TURDS")

4.) SCORING: SCORE WILL BE BASE ON A PER CRAFT TOTAL. CRAFT WITH HIGHEST TOTAL WILL BE CONSIDERED THE WINNER.

HITTING WATER CRAFT: 5 POINTS

HITTING MOVING WATER CRAFT: 10 POINTS

FURTHEST LANDING DISTANCE FROM SHORE: 20 POINTS (DISTANCE TEST)

Guns in Schools

*Thorough &
logical. A few
errata however.
69/75
Nice job.*

By:

Eric Harris

period 4

12/10/97

Mr. Webb

2. "Junk Guns," also known as Saturday Night Specials, are handguns that are extremely small, inexpensive and typically poorly made (Junk Guns).
 - a. The fact that these guns are small and inexpensive implies that these "junk guns" can be found and purchased easily by students.
3. School security experts and law enforcement officials estimate that 80% of the firearms that students bring to school come from home, which shows where most students get their weapons. (Harrington 22).

Guns in schools are a growing problem in today's society. Every day the news broadcasts stories of students shooting students, or going on killing sprees, or even just bringing a gun to school. Students bring guns to school for many reasons. Some for protection, some for attacking, and even some to show off. However, a school is no place for a gun. Solutions for this problem are hard to come by and often too expensive for most schools to even consider, however metal detectors and more police officers are two very good solutions.

Metal detectors posted at entrances in schools can prevent guns from entering schools. That is a given fact. Although, the cost of these machines ^{is} are rather high and some schools simply can not afford them. Tax payers and donations are other ~~ways~~ to form money to buy detectors, but some tax payers would not be happy with the prices. Several schools in the United States have metal detectors, and shootings still take place in the school. Students can be very resourceful, and can find ways to avoid the detectors. The idea of more police officers is a very good solution. However, this would also cost more money for the tax payers. The end result, in my opinion, is worth every penny spent.

Metal detectors and other forms of detectors are very good solutions. Once installed in all main entrances, students can simply walk through while trained officers can search suspicious

bags and backpacks if the alarm goes off. Students will be much more safe, but the fact of low morale is still present. One problem with metal detectors is that several school-related items are metal and would most likely set off the alarm. This leads to several searches that turn up nothing. This can cause long lines and be a hassle for students trying to get to class.

Police officers can discourage students from bringing weapons and can stop anyone who manages to get a weapon in the school. They are there to protect and serve, so students can go to them if they want to report someone with a gun or any other incident. More cops in schools is a great start to preventing more shootings in schools. On the other hand, the more cops in a school the more it begins to look like a prison. The community does not want it's schools looking like jail houses with the children as the prisoners. They are there to learn and, if students feel uncomfortable, that only leads to more problems. Drop-outs, grades, and student morale would all get worse with the presence of police, even though the cops are there for the students safety. Therefore, only a few cops should be assigned to schools at first. The schools should let the officers and the students get familiar with each other. This familiarity will help the morale of the student body.

More and more we hear of shooting sprees and rampages on the news. Some can be prevented, some can not. Almost any school shooting could have been prevented in some way or another, we just have to spend the necessary time and money to figure out how. Metal detectors and more police officers are only two good solutions. If tax payers can afford to do one or both of these solutions, then that is fantastic. If not, then the community needs to figure out other ways to keep guns out of schools. Students can not learn very well and be motivated if they know that someone in their classroom has a gun with them. In conclusion, metal detectors and more police officers are a great start to the fight against guns in school.

Eric Harris
12/11/97

Works cited

Centers For Disease Control. "Weapon Carrying Among High School Students." Morbidity and

Mortality Weekly Report. Vol. 40 No. 40. 11 Oct. 1991.

Gun Digest 1995, 49th Annual Edition. Northbrook, Il. DBI Books, Inc., 1994. 288.

Harrington, Donna. "Blown Away." The American School Board Journal. May, 1992. 22.

"Junk Guns." On-line. Available: www.gunfree.org/csgv/bsc_jun.htm. 9 Dec. 1997

YOU KNOW WHAT I HATE!!!!?

—SLOW PEOPLE!! You know those people who walk like a lifeguard on baywatch runs! Slow as molasses! MOVE IT OR LOOSE IT PUNKS!

YOU KNOW WHAT I HATE!!!!?

—When there is a group of trendy punk like little smart asses standing in the middle of a hallway or walkway, and they are just STANDING there talking and blocking my way!!! Bloody snotty people think they are god almighty and can just stop and talk away wherever or whenever they please, learn some manners you stuck up people!!

YOU KNOW WHAT I HATE!!!!?

—When people dont watch where THEY ARE GOING! Then they plow into me and say "oops, sorry." or "watch it!" NNNYAAAA!!! Like it couldnt possibly be their fault that we collided. Oh, heaven forbid your holy graciousness being the cause of something baaaaad.....RRRRRR!!!!

YOU KNOW WHAT I LOVE!!!!?

—When some rich stuck up piece of s!@# white trash person gets in a car wreck with their brand new car!

YOU KNOW WHAT I LOVE!!!!?

—When some stupid retarded kid blows his damn hand off because he couldnt figure out that a lit fuse means that the firecracker is going to go off soon! HAHAHA!!

YOU KNOW WHAT I HATE!!!!?

—OOOOOOOOJAAAAAAAAAAAAAY!!!!!!!!!!!! GOD I F-ING HATE THAT WORTHLESS TRIAL!!! Who in their right feeeeeeRRRIGIN mind would care about that trial??!? its not any different from any other murder trial! Tell those worthless reporters to get a life! And what the hell do we have to gain by watching that stupid trial anyway!?! Its not news! its a trial! not news! trail! Trialdoes not = news!

YOU KNOW WHAT ELSE I HATE!!!!?

—Jon binay however the flip you spell her spoiled name Ramsee!!!! We dont care! Good flipping riddens!!! What the flame do you expect if you flicking put your kid in all these beauty pagents when shes 4 years old!! Makes her look like a SLUUUUUUUUUUUT!!!!!!

YOU KNOW WHAT I HATE!!!!?

—STUPID PEOPLE!!! Why must so many people be so stupid!?!?

YOU KNOW WHAT I LOVE!!!!?

—Making fun of stupid people doing stupid things! Like one time when i was watching this freshman try to get on a computer that needed a password....he typed in the password.....and waited. The retard didnt press enter or any thing. He just waited. Then he started cussing at the computer saying it was screwed up. Then the freshman went and got a teacher and the flippin teacher could not figure out why it wasnt going anywhere!!! JESUS!! Personaly i think they should be smacked across the face a couple million times er so.....give or take 1.

YOU KNOW WHAT I LOVE!!!!?

—Natural SELECTION!!!!!!!!!!!! God damn its the best thing that ever happened to the Earth. Getting rid of all the stupid and weak organisms.....but its all natural!! YES! I wish the government would just take off every warning label. So then all the dumbasses would either severely hurt themselves or DIE! And boom, no more dumbasses. heh.

YOU KNOW WHAT I HATE!!!!?

—RUDE PEOPLE THAT CUT!!!!!! Why the flip cant you wait like every other human on earth does. If you cut, you are the following: Stuck up, self centered, selfish, lazy, impatient, rude, and.....damn i ran out of adjectives. anyway. Every flippin line i get into i end up having to wait a flaming hour when there WAS only me and 1 other person in the line! Then the asshole lets all his/her so called friends cut in behind em!

YOU KNOW WHAT I REALLY HATE!!!!?

—LIARS!!! OH GAWWWWWD I HATE LIARS. And living in this neighborhood there is thousands of them!!! Why the flip must people lie so damn much! Especially about stupid things! Like "Yeah, i just bought 5 cases of M-80's in Oklahoma for about \$5. And they are legal there and everything. Yeah my parents buy most of my guns, every once in a while ill use my 4,000 dollar paycheck and buy a shotgun or 2. And my brand new hummer just broke down on the highway when i was going 250mph. Stupid cars." like that. now. what flaming part if any would a normal human being believe? And thats just one person!! Another BIG example is Brooks Brown(303-972-0602). Now, according to him, he has a 215 IQ, 5 other homes (2 in alaska, and 3 in Florida), 95mph fast ball(he is only 16), runs a mile in about 5 minutes, has an uncle thats the former head of all the armed forces and has access to.....Theee Button..., his other uncle is a multi-millionaire that lives in downtown detroit, and his neighbors are the chick that sang "r.e.s.p.e.c.t." and the lead singer of Aerosmith. And that same uncle owns 30%

of the stock of that tylenol company, And his grandparents gives..GIVES...him about 1000 dollars for each month, and his other Grandpa can blow up every house in America because all the houses have C-4 in the foundations. Again, according to Brook Brown. OK, when people lie like that, its not impressive, noone believes it, it sounds just plain stupid, and its a friggin waste of my time.

YOU KNOW WHAT I HATE!!!!?

—R rated movies on CABLE! My DOG can do a better damn editing job than those tards!!! For the sake of all television they can at least try to make it sound like actual words the person would say! If you have ever seen Aliens or Predator you'll know what I'm talking about.

YOU KNOW WHAT I HATE!!!!?

—Windows Keys!!!!

YOU KNOW WHAT I LOVE!!!!?

—WAREZ!!! Why pay when its free?

YOU KNOW WHAT I HATE!!!!?

---People who think they can forecast the weather!!! Then they think that everyone else will think that they are cool just because you said that we were gonna have a 4 foot blizzard starting today! Like just the other day, this punk i know was saying.. "Yeah tomorrow we are gonna get like, 2 feet of snow in just a few hours, They were saying its gonna be the biggest snow in ten years. Yeah. Itll be about -60 outside too." And that day we get an inch of snow and its 26 out.

YOU KNOW WHAT I HATE!!!!?

---Cuuuuuuuhntryyyyyyyyyy music!!!

YOU KNOW WHAT I LOVE!!!!?

---Zippo Lighters!!!!

YOU KNOW WHAT I HATE!!!!?

—People who say that wrestling is real!! now, im talking about the matches like hulk hogan or undertaker. If you think that these matches arent faked and that these guys are REALLY punching and breaking arms, then please mail me. I would love to know where you live so i can BOMB your fucking house and ACTUALLY BREAK YOUR ARMS!©

YOU KNOW WHAT I HATE!!!!?

—YOUNG SMOKERS! they think they are so god damn cool with their big bad ciggarettes and their "sooo cool" attitude. I cant wait until they are about 25 and have to breathe through their friggin necks and talk with a computer hooked up to their formal-vocal cords.

YOU KNOW WHAT I HATE!!!!?

—PAYING FOR MY CAR INSURANCE!!!

YOU KNOW WHAT I LOVE!!!!?

—FREEDOM OF SPEEEECH!!!

YOU KNOW WHAT I HATE!!!!?

---Freedom of the press. I hate that part of the Bill of Rights.

YOU KNOW WHAT I HATE!!!!?

—People who are against the death penalty!!! i think the courts should flaming fry every convicted felon out there!

YOU KNOW WHAT I LOVE!!!!?

—SCHOOL!

YOU KNOW WHAT I HATE!!!!?

---SCHOOLWORK!

YOU KNOW WHAT I REALLY HATE!!!!?

---COMMERCIALS!!! OH GAWWD I HATE COMMERCIALS!!! The only ones i MIGHT like are previews and some car commercials. But jesus christ, all those Lotion, PERFUME, Makeup, JCPENNYS, Joslins, food, coffee, or advertisement commercials! Please! Destroy them all! never record another! They suck! They are only funny the first time! Think up other stuff! They suck! They are stupid! We get sick of them VERY FAST! VERY! VERY FAST!

YOU KNOW WHAT I HATE!!!!?

---TRENDS!!! I HATE trends! Like tommy hilfiger or mossimo or SKA or those little chapstick lip gloss lip cream CRAP that every freakin girl in middle and high school carries around! They are just so.....DAMN.....rrr.....RR... ANNOYING!!!! YAAAH!!! RRRRR!!!!

YOU KNOW WHAT I HATE!!!!?

---People who dont believe in personal hygiene. For the love of god. and for the sake of god, CLEAN UP! Frickin people with 2 inch fingernails and a whole frickin flower pot full of dirt under them and raggy hair or shirts stained to hell. Or people that just plain stink, and they dont do anything about it. Now, im not making fun of anyone if they cant help it, or afford it or anything like that, thats not their fault, but if your some kid drivin a ford explorer and have yellow teeth, then thats just plain unhuman.

YOU KNOW WHAT I HATE!!!!?

---People who use the same word over and over again! Like, "actually", or "shazame", or "nifty". Read a fuckin book or two, increase your vo-cab-u-lary ya f*ck*ng idiots.

YOU KNOW WHAT I HATE!!!!?

---People who try to impress me by TRYING to brag about the militaries weapons! Now, to some of you this might seem, wierd, but its happened. Like this, "dude, they just came out with this new chemical that can destroy denver only using a cubic inch of it. The military is keeping it all locked up because if it gets to close to water it explode, and the force would create a cresent earth, maaan." Yeah, right, bullshit, or like this, "Dude, the air force has tracked santa clause for like, 10 years now, he is real man. its all a cover up." or "The air force just made a plane that can bend light man, its completely invisible." now, this is just some of the shit i've heard. it makes me SICK. And they arent even in the frickin military nor do they know anyone that is even if it WAS true and like they would know about it! GAWD!! I HATE those PEOPLE!

YOU KNOW WHAT ELSE I HATE!!!!?

---People who THINK they are martial arts experts! They are all cocky and thinkin that they are all big and bad. saying bullshit like, "yeah if you snap your fingers right here the sound waves will melt the brain and youll die from your own brain poring out your ears." or "if you flick someone right here their arteries will burst and they will drown in their own blood." freakin hate it when they keep sayin "your own", like it would be someone elses!?!? then when these shitheads get in real fights the get their frickin asses wooped all over the place by some little girl.

YOU KNOW WHAT I HATE!!!!?

---STAR WARS FANS!!! GET A FaaaaaaRIGIN LIFE YOU BORING GEEEEEEKS!

YOU KNOW WHAT I HATE!!!!?

---RACISM!!! Anyone who hate blacks, asians, mexicans, or people from any other country or race just because they arent from here or are a different color...woopie freakin doo man. And that goes for black people too. I've seen people on Ricki Lake or Opra or whatever saying things like "white boy, whitie, you say dat cuz you be white, yea..you white people all du same, she be white, so she baaad, I bet he did dat stuff cuz he a white boy" allll that stuff just pisses me off to no end. It is possible for BLACKS to be RACIST too ya KNOW.....people who think that should be drug out into the street, have their arms ripped off, be burnt shut at the stumps, then have every person of the race that YOU hate come out and beat the crap out of you. You people are the scum of society and arent worth a damn piece of worm crap. You all are trash. And dont let me catch you making fun of someone just because they are a different color because i will come in and break your f*ck*ng legs with a plastic spoon. i dont care how long it takes! and thats both legs mind you.

YOU KNOW WHAT I HATE!!!!?

---THOSE FREAKIN ADVERTISING OR CHARITY CALLS! People saying "Hi, im not selling anything but"--- good, now shut the flip up and go get a real job!---well! you are so rude!"---damn strait and if you dont get off my line ill come down to your building and shove that phone list up your arse and take the phone and shove it up your boss's arse! "click" heeheehee, that would be cool.

YOU KNOW WHAT I HATE!!!!?

---When people mispronounce words! and they dont even know it to. like acrosT, or eXspreso, pacific (specific), or 2 pAck. learn to speak correctly you morons.

YOU KNOW WHAT I HATE!!!!?

When people drive really slow in the fast lane!!! GOD!!! Those people do NOT...NOT..NOT..NOT know how to drive!! Anyone who knows anything about driving knows that if you are passing someone or going really really really fast, you should stay in the slow lane!! Anyone caught doing that should be sent to every driving class available for a flaming year!

YOU KNOW WHAT I HATE!!!!?

THE "W.B." network!!!! OH JESUS MARY MOTHER OF GOD ALMIGHTY I HATE THAT CHANNEL WITH ALL MY HEART AND SOUL. Their stupid "dubba dubba hey dubba hoe dubba B dubba boo dubba foo dubba dubba wubba lubba HEY dubba hoe dubba" CRAP!! Are they purposely doing that just to piss me off!!!!???

JESUUUUS!!!

YOU KNOW WHAT I HATE!!!!?

Basketball!

YOU KNOW WHAT I HATE!!!!?

PUFFY DADDY OR PUFFY COMBS OR PUFFY SMALLS OR WHATEVER THE HELL HIS NAME IS!! I hate that guy!!!! Why doesnt anyone "bust a cap" in his ass??? He cant even rap worth a damn! All his songs are like "mmm yeah huh Uu Uu Uu yeyah mgmmmbmm yeeeyahh jiijeya Uoo UU uu.....mumtmdlkg mmmmmmtgmmmm yaaahh.... Uu..." and stuff. I HATE THAT GUY!!!

YOU KNOW WHAT I HATE!!!!?

PEOPLE WHO ARE MEAN TO ANIMALS!!!!!! The only promise I make in this whole page is this: if I ever see anyone on god's green earth harm a dog or be mean or unkind to any mammal, I will SEVERELY hurt you, I swear to god, I swear on my computer, on my car, on my fucking LIFE I will hurt you.

YOU KNOW WHAT I LOVE!!!!?

Driving FAST!!

YOU KNOW WHAT I HATE!!!!?

SKA!

YOU KNOW WHAT I LOVE!!!!?

Good, fast, hard, strong, pounding TECHNO!! Such as KMFDM, PRODIGY, ORBITAL, RAMMSTEIN, and such.

YOU KNOW WHAT I HATE!!!!?

RAPPERS AND THEIR OH SO SMOOTH COOL SUAVE RAPPER ATTITUDE!!!!!!

YOU KNOW WHAT I HATE!!!!?

RAP VIDEOS!!! Every geeewd damn one of them is the same! 5 chicks all with color coordinated outfits and little nylon jackets and spandex pants dancing around while some dorky rapper moans and groan around and drives a fancy car and waves his arms around acting like a freakin DORK!

YOU KNOW WHAT I HATE!!!!?

HOMOSEXUALS!! It is just plain WRONG.

People who tell me what I think or what I do or what I should say! Sometimes its ok, like if its a psychiatrist or something, but if its just some other "dude" at school telling me I shouldn't think something or some teacher telling me I cant go down some hallway, then I say FUCK YOU I do what ever the figgide flame I want!!

YOU KNOW WHAT I HATE!!!!?

G rated MOVIES!! Like the Lion King or HERCULES or Warriors of Virtue. I don't care who they are made for I DON'T LIKE THEM!

YOU KNOW WHAT I LOVE!!!!?

FREEDOM!

YOU KNOW WHAT I HATE!!!!?

U.S.A.'s La femme Nikita. Stupidest damn show I have ever seen. Little swat team navy seals wanna be dorks.

YOU KNOW WHAT I LOVE!!!!?

PUNCHING THINGS!

GREEN MOUNTAIN GUNS INC.

303-985-7240

PHONE #

ORDER# 4090

DATE: 12-18-82

NAME: Eric Harris

ADDRESS: [REDACTED]

STATE: CO

ZIP 80109

AMOUNT: ~~0.00~~ 135.00

TAX: 8.51

143.51

TOTAL:

DEPOSIT:

TOTAL DUE:

CITY: Lakewood

ITEM TO ORDER: Hi-Point 9mm carbine magazines
9 mags @ \$15.00 EA

*11/11/82
KORV*

* ALL SPECIAL ORDERS ARE NON-REFUNDABLE *
* DEPOSITS ARE NON-REFUNDABLE *

JEFFERSON COUNTY SHERIFF



green mountain
guns receipt

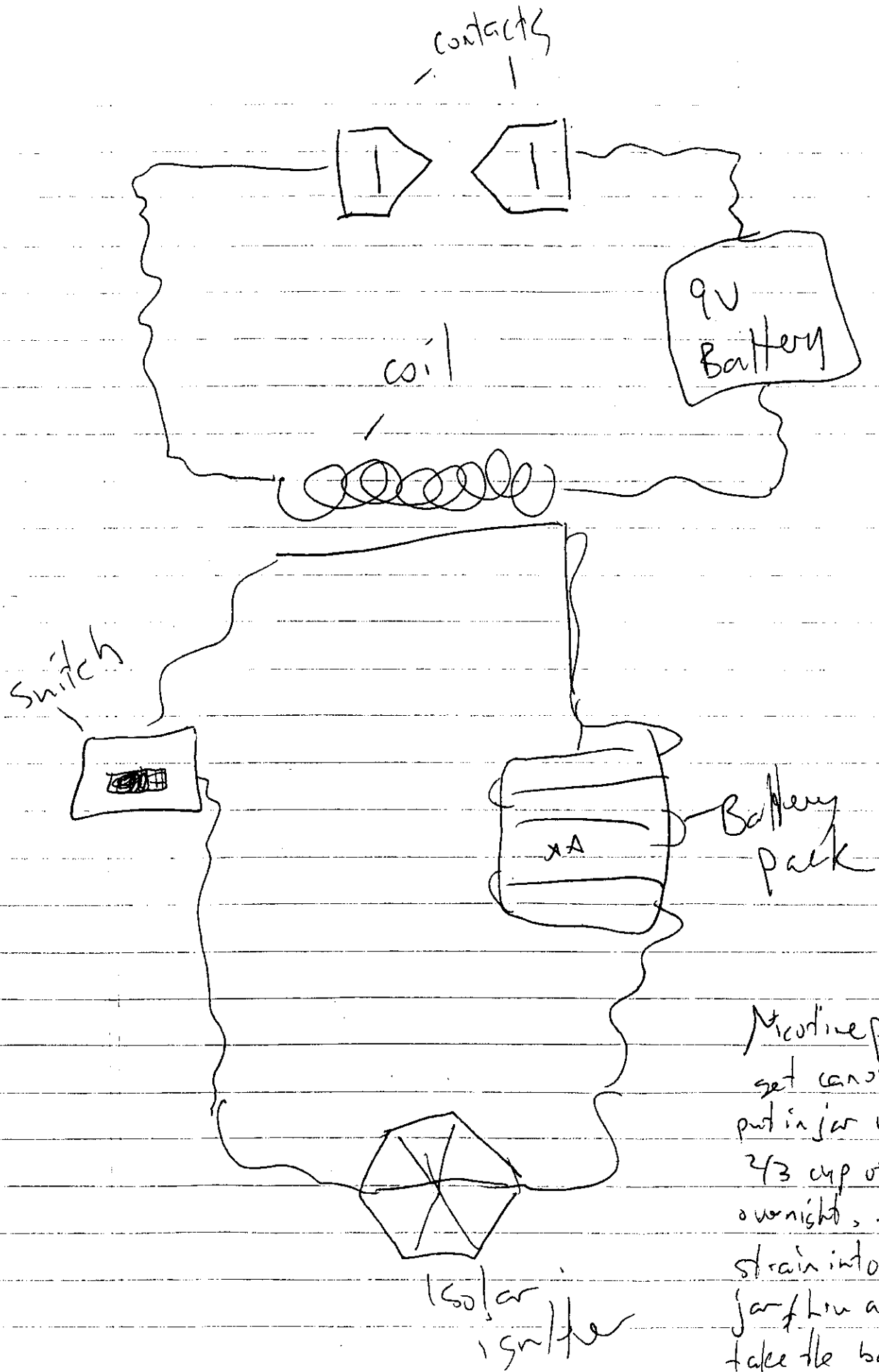

Medicine poison:
 set can of tobacco
 put in jar w/ about
 2/3 cup of water
 overnight, next day
 strain into another
 jar & throw away
 tobacco & squeeze
 out ~~all~~ the liquid

yes

up

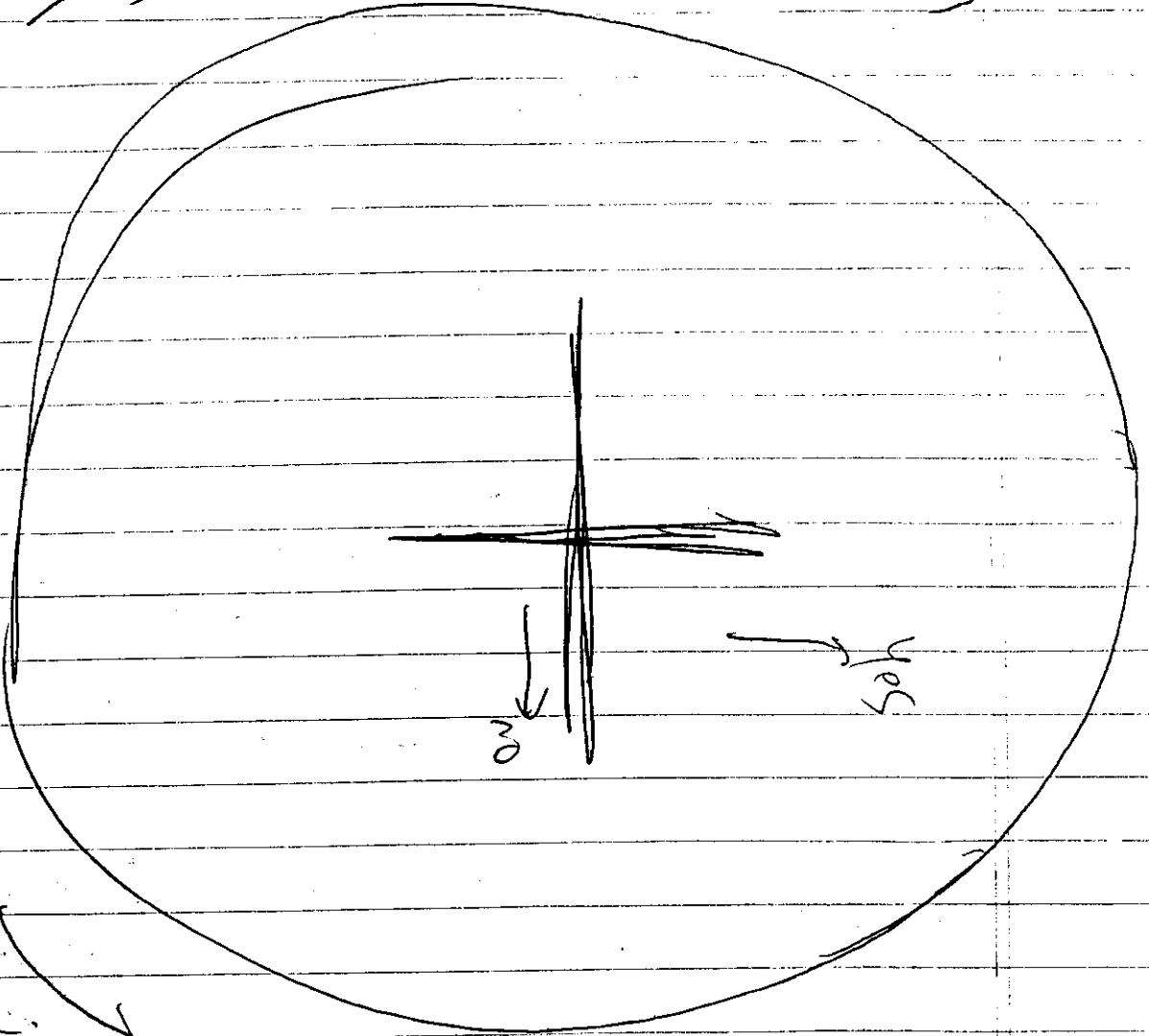

no

yes

i dont know

right

Soundwave 800 cartridge

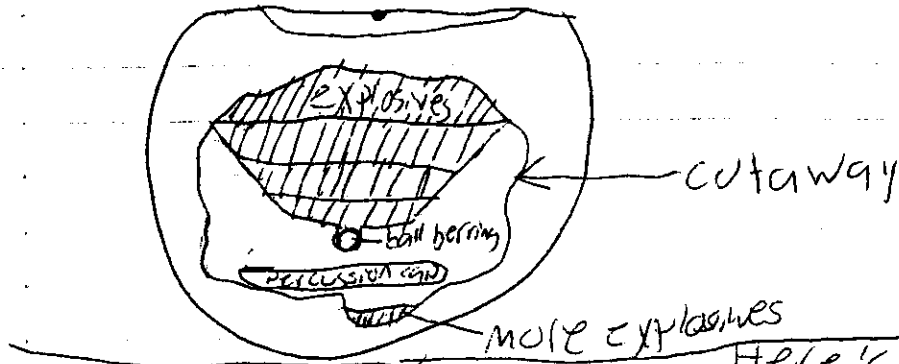

Here's what happens



sound waves from ball bearing hitting percussion cap.

YOU GOT A CAPSULE OF SOUNDWAVES

capsule (size of barrel)

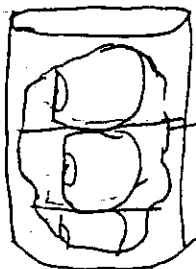

another cutaway



screen

roll in blanket
for noise reduction

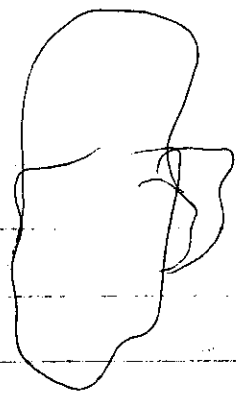

Black duffle bag w. 2 Flashlights
roll of Duct tape
Box of milk bones

leather gloves
over surgical
gloves

~~black neck gator~~
black neck gator for hair
black face paint
top 1/2 - peel
shirt

Tucked
in

2 FDS

2000 shirt - newly
washed
no cat hairs

belt

black jeans
nothing
in pockets

size 12 shoes - duck foot

- ?
- ① Get exact address for new houses: ([REDACTED])
 - ② Get phone #. fr. answering machine. - long day span
 - ③ Get a Social Security # & corresponding name ([REDACTED])
 - ④ Call Visa: give them info for mailed card
 - ⑤ Pick up card at drop off pt. ^{accident}
 - ⑥ Go to western union machine: Use auto out of state clause
 - ⑦ Sign card slip w. fake name [REDACTED] [REDACTED]
 - ⑧ collect cash or check
- ↳ ⑥ check: go to Lakewood check-cashing store: get cash
↳ put card almost to limit, burn all evidence.

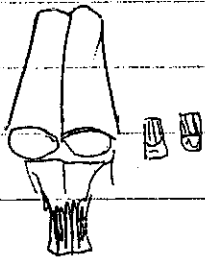

→ "Leather trench coat" ←

CD case - ~~50~~⁵⁰ pack (plastic floppy sleeves)
SPB Ave 64 gold card

CDs

movies

\$

~~pipe & gold tobacco~~

Heten 2 - computer game - original game

~~cut & gold payment~~

Both finger armor - plate mail, no spikes

CDs

→ The Doom Generation - sdtk ←

Vampires - sdtk

Ceiba - any

Prana - any

Antechre - Amber

→ Smashing Pumpkins - Box Set ←

⊗ Spacetime Continuum - Any Xpt Sea Biscuit

Nowhere sdtk

Renegade Soundwave - any

Movies

Reservoir Dogs

Vampires

→ Lost Highway ←

From Dusk Till Dawn

Tiny Socks
Red D Videos

[REDACTED] [REDACTED]
[REDACTED]
Us playing Riff

~~US~~ Us faking cafeteria shots
You know what i made
Films of peoples backups
Deathmatch segments

[REDACTED]
Make you can seem better!

Full shit : (Need skill)

Finger armor - right middle

~~Leather Duster~~

Uzi 9M

~~DB~~

2 calicos

~~Neckties~~

Flask

(S) HIT LIST

(S)	[REDACTED]	*	[REDACTED]
(S)	[REDACTED]	*	[REDACTED]
(S)	[REDACTED]	*	[REDACTED]
(S)	[REDACTED]	*	[REDACTED]
(S)	[REDACTED]	(S)	[REDACTED]
(S)	[REDACTED]	(S)	[REDACTED]
*	[REDACTED]	*	[REDACTED]
*	[REDACTED]	*	[REDACTED]
*	[REDACTED]	*	[REDACTED]
*	[REDACTED]	*	[REDACTED]
*	[REDACTED]	*	[REDACTED]
*	[REDACTED]	*	[REDACTED]
*	[REDACTED]	*	[REDACTED]
*	[REDACTED]	*	[REDACTED]
*	[REDACTED]	*	[REDACTED]
*	[REDACTED]	*	[REDACTED]
*	[REDACTED]	*	[REDACTED]
*	[REDACTED]	*	[REDACTED]
(S)	[REDACTED]	(S)	[REDACTED]
(S)	[REDACTED]	(S)	[REDACTED]
(S)	[REDACTED]	(S)	[REDACTED]
(S)	[REDACTED]	(S)	[REDACTED]
(S)	[REDACTED]	(S)	[REDACTED]

~~So Mamma~~ → Pulp

rappers, others

Some of
~~some~~ Hate

→ Black
Sunshine

- pissed off guy, knife, others

~~Love = ~~Atch~~ Tech no mus, cars & driving, pussy, go Hit,
Red shit, ~~arez~~, weapons, explosives (for fast)~~

lawyers,
psychiatrists,

Have = Liars, punk fags, bitches who hang w. them,
← commercials, ~~etc~~ faggots at work, people who hang in
songs & think their cool, NBC, The WB, ^{top} America checkers, Socks,

grammar, Alt. ~~mus~~, Age limits, Texas, Pussy Rap,
martial artists, ^{*} Laid Back ^{*} people, prizes of staves shit, ~~people~~
~~the~~ Rich people, Amazing people, speed limits, salesman,
Charity-commercials, wannabe experts of stuff, ~~the~~ fag detectors,

Star wars bass, Stupid people, faggot skin fm of retard, popular lame ass
situation,

~~the~~ Assorted people, NPR, Paparazzi, engineer mags,
Rich. take people, WIF fans, cops, Curfew fans, ~~the~~ celebrity benefits,

People that say they kick ass cause only their stacy, welfare moochers,
lover takes, HANSON, JTI, that's all (Tommy White)

←
Fascists
wannabe
comedians
People who are
assholes to
chicks,
insults,
some constant rights,
retards, selfish people,
trends, fashions

Pics = of groups

Tech no

→ ~~the~~ Black Rock in
~~the~~ Bands

Description, Lists, Links

Lyrics

Lists of All songs w. good lyrics

- something I can name

pics =

Wackling

→ Particle man

Summary of ALL fags warez & hacking computers, others

CoolIOS

→ sweet dreams

B&B utlead
pics
others

List of eunypre,
Their poses, possibly mail slot

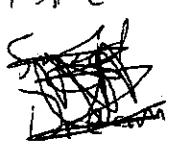
disarm 

My Thoughts

Everything you want
tell about religion, philo, etc.

Picz = ~~pentagram~~, ~~conradmint tablets~~,
~~anarchy~~, peace symbol

& ≠ - explain

Other Cool MUS

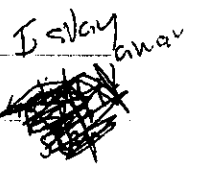
→ 

Tell all other groups - non-techno
you like

Pics = NIN, others of music

movies

→ little green
Bag

explain good movies

Pics = Resdoss, others

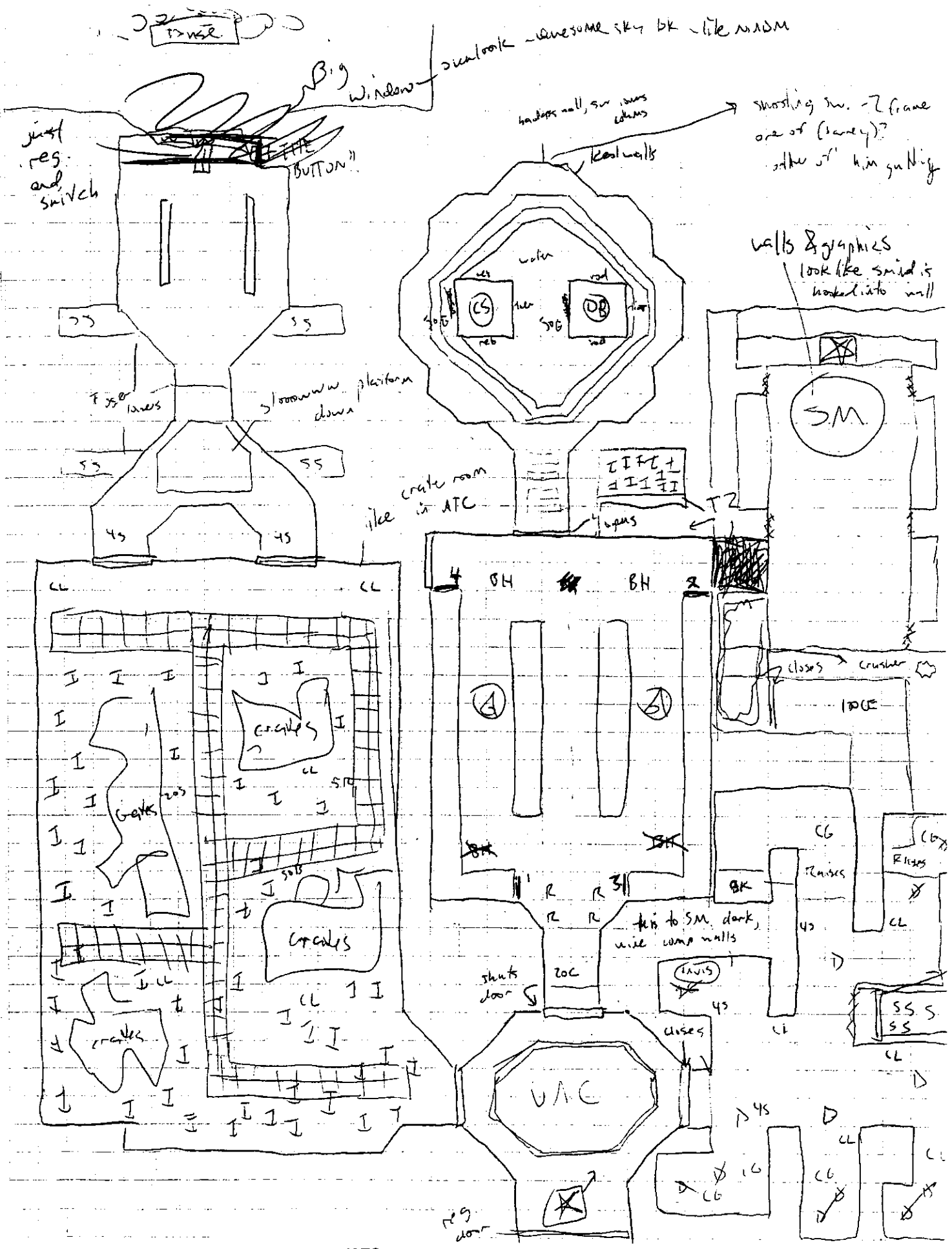

Comp. Textures from Reb
Forest Background

- ~~ceiling floor~~
- 256 ceiling ~~alpha~~ ~~skit~~
- Arrow passage triggers
- Left door
- ~~right door trigger~~
- X mid ~~door track~~ to plain
- ~~door bottom~~, both L & R
- make water rings 256 L
- stone floor grids, rings
- fix fencing
- 256 ceiling ~~beginning~~
- fix ~~back V~~

-
- ~~door doors~~
 - change ~~both front~~ ~~central door~~ ~~top needed~~ ~~vis skit~~
 - change ~~lighting~~ ~~materials~~
 - close ~~inner~~ ~~neighbors~~ ~~to~~ ~~metal~~ ~~something~~
 - change ~~grade~~ ~~to~~ ~~tiny~~ ~~squares~~
 - put ~~doorstop~~ ~~rooms~~ ~~sides~~
 - take out all lights

Cat/Rat?

~~Z ESDE~~

E

Yearbook

E

Phantom Planet

N

KMFDM Zombie

Z

Comp shirt (cardboard box)

Siamese Dream

Spotted

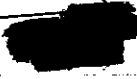
Oddysey Wides - 

~~Delete All backed~~

Run NVDX, kill the Fucking Virus

Delete all backed up shit

write down
all desktop
configs,
ss, etc.

Backup Remaining stuff. on portable HD, Zip Drive, etc

~~Re-Partition Drives~~

Put in 56k Modem, put CDrom on master (2)

Re-Partition Drives same grouping, ALL 32-Bit

Go to [redacted] machine or downstairs, get ALL

Drives for your
problem on ~~the~~
floppies

Re-install Win 3, custom setup

re-load all programs, put all back on HD's

re-set configs

NA

Creators

Creators

Warcraft expansion
C&C T3
Heres 2
Redneck Rides again
Shadow Warrior
Tomb Raider 2
AOE 2
Heretic 2
Total Annihilation
X-com Apocalypse
Diablo
Diablo 2
Starcraft
Tomb Raider
~~Unreal~~
Quake 2
Soul Knight
Need for speed 3
Deer Hunter
Links 98
Triple Play 99
Ignition

- Last Highway - black, ^{center of front}
 - So mammal - green, ^{yellow} letters
 - Tommy Hilfiger is GAY - ^{reg. marks}
 - closer to good - black ^{center of shirt}
 - chambers-electronik ^{front}
- ↓ chem logo
- Electrobank name
- Picture on front
- who... ^{front} back

BUYING OR SELLING A HOME?
CALL RANDY BROWN (303) 973-1380
 Broker Since 1980
 G.R.I. Since 1980
 C.R.S. Since 1983
 Construction Expert
 State Registered Appraiser
RANDY BROWN REAL ESTATE INC.
FOR THE BEST IN REAL ESTATE SERVICE®



Independent Companies
 Working Together

Its cool to hear,

~~lets gooooo~~

~~kill it all~~

wow-NADA! got you a fuckin' check

~~sooooo~~

~~fuck it~~

You what i have ??? yeeea!

Fuck you AND yo mother fuckin

So I Fut yo Bitch

Jeeeeeaa!

So mamma

So

- Fear
- Stupid
- Ugly
- Wild
- Cried

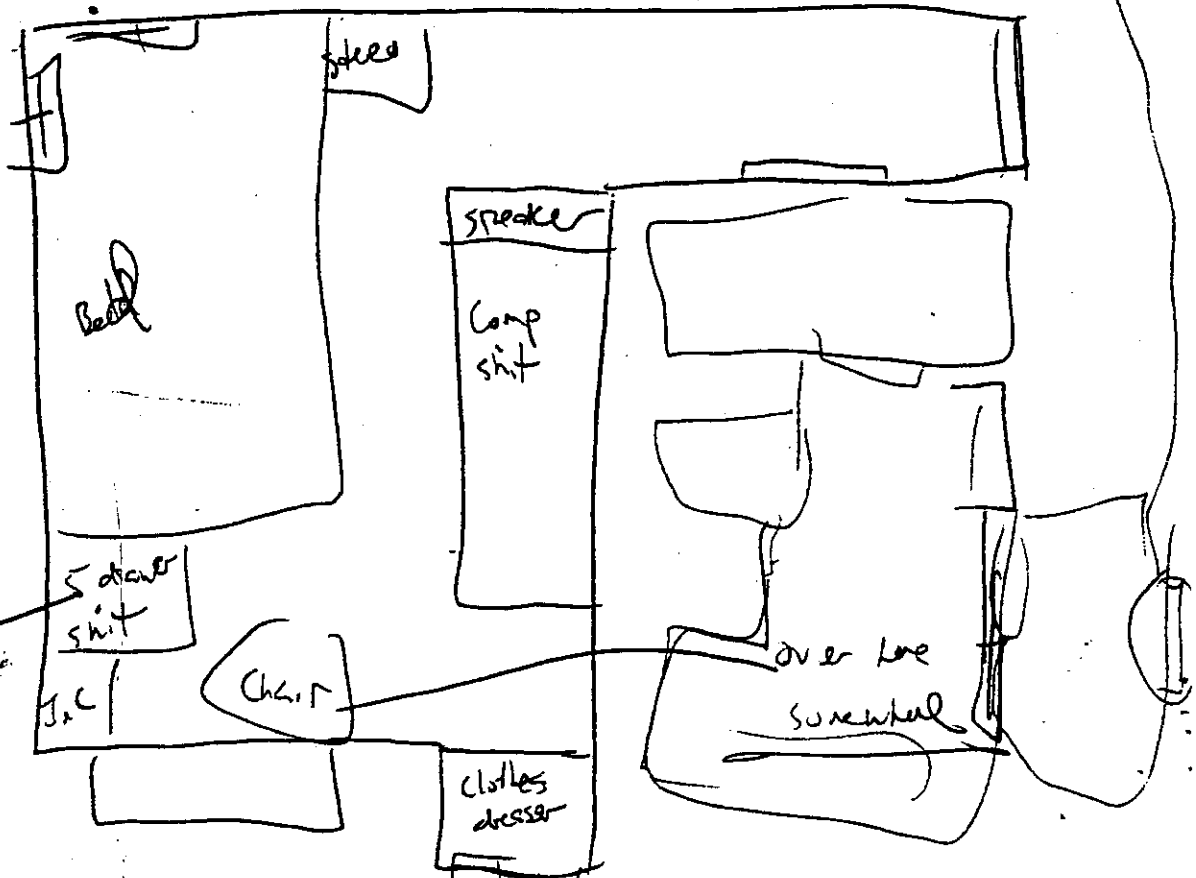
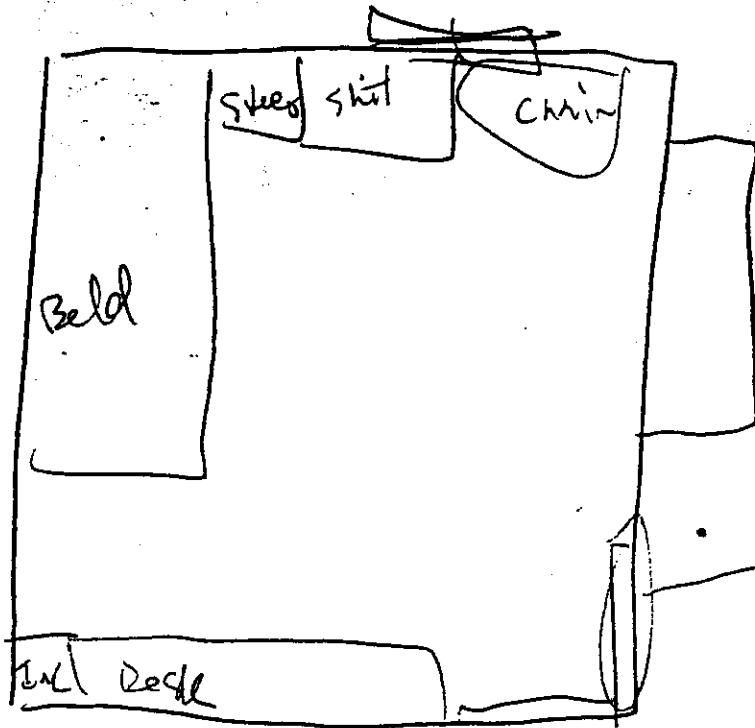

Speaker
on top

	Full	Demo
CPB	171.64.65.70	204.253.208.225
[R] CTF	202.27.184.4	209.3.5.232
3team	199.69.51.102	game.ott.igs.net:26002
Junk	199.217.218.7	yavin.res. ^{CMU} edu:26001
[R] CTF	128.6.209.5	207.152.95.9
Pak2	204.177.71.250	Quake VIP.net
[R] CTF	206.135.92.4	203.61.156.164
[R] Mega	38.241.229.103	209.113.72.13
CTF/fruity	209.26.6.121	128.252.22.75
	Quake.sonic.net	209.116.84.146
	Quake.Provide.net	Quake.15152N.net
Pak 2 (?)	Quake.shadow.net	Quake.Dsnpv.net
CTF [R]	Quake.cifnet.net	Quake.Dread.net
	206.147.58.45	153.38.8.40
CR	Quake.ACI.net	209.222.147.6
CR	Quake.APCI.net	207.30.184.20 CR
CR SAME	Quake.TISD.net	Quake.TX3.com CR
CR ↓	Quake.Testengeer.com	209.172.184.218 - Junk
MEAN	Quake.IONET.net	Quake.Champion 26666
CR	207.28.217.125	163.117.128.62
CR	204.248.210.20	199.72.175.4
	204.1.168.3	192.107.41.7 - Morris'
	206.25.206.10	HED.RES.WPI.NET - CR

LAN/EXL 724
 151.154.102

270.0.0.1
 CPM.POLICE.EDU
 DMIT.EDU
 UConn.KIANT.EDU

209.249.214

CR.1M(CW)EDU 26003

□ VODKA □	Fog killer	24,66.11.207
salt lick	Super Nigger	Scout - 142.194.53.134
tomato picker	KIMEDM	204.186.43.74
sun gardening	Zombie	Needro
cole skew +	Somboro	King - 38.27.54.85
friscuit knife	Debug	156.46.37.122
trash bag	est/66-sun/bamSex	208.142.85.171
15.15.16	Kingston	206.139.95.142
201.271.0.505	Zester	216.76.94.134
		258.241.44.135
ICQ	20304395 201.151	
8310672 (King)	King (D.N-invisible)	209.104.84.231
		201.104.84.231
ICQ Parker X (Dadment)		209.232.99.136
8310672 - Optical Illusion (Nemesis)		206.147.18.60
Dissident or Daloustin (Crimson)		208.22.24.31
12.21.154.52	Earle-Tricky (LLAMA killer)	161.142.16.181
WATERBOY 10346	SEVZ	138.26.127.99
19890948	Slippy (Sin-Demise)	209.116.9.107
27226690	Diffusion (Hexed)	206.152.102.43
	Lil Naz	139.67.16.67
	Sin-raige (SP)	169.191.18.237
	Sin-sleeper	38.11.196.104
	The Flame	207.193.243.122
	Sin-demise	21642208
	Eyecelstion (SP)	207.243.122.150
	NW-Hercules	204.77.184.157
	Morph	208.251.246.82
29341299	corpess	207.177.4.169
		208.254.248.207

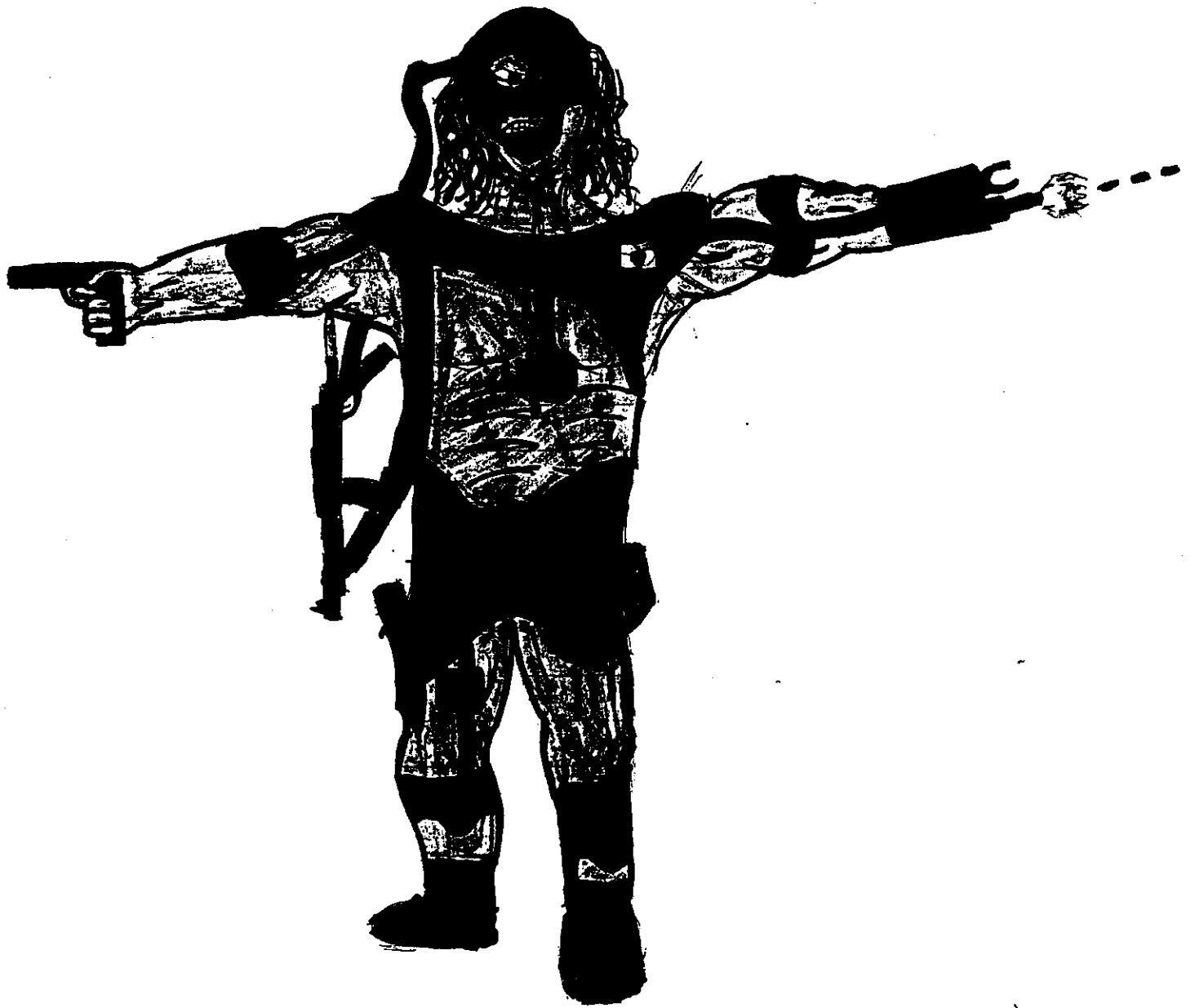

JC-001-026384

2/1/01
3-51

The document described below
has been removed

Description of Document: Newsweek
Article, October 14, 1985, pp. 47-48

Date of Document: October 14, 1985

Reason for Removal

- Copyright
- Bomb-making instructions
- Medical Records
- Other

Comments: _____

-act: People are so unwise ... well, Ignorance is
bliss to guess... that would explain my depression
-Dylan

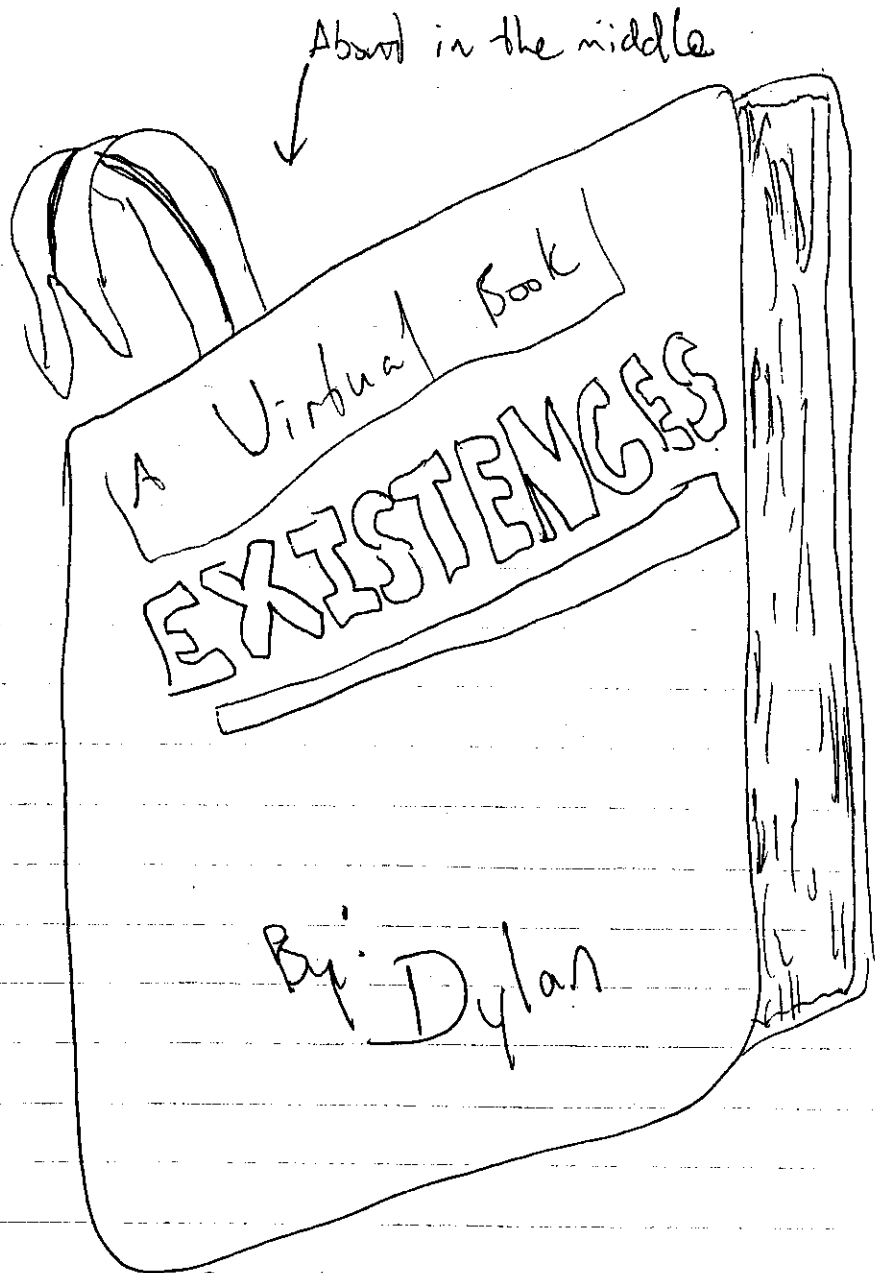

Properties: This Book cannot be
opened by anyone not
Dylan. Some supernatural
force blocks common people
from entering

JC-001-026385

←-valked-→
←-DyLaN-→

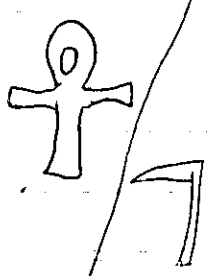
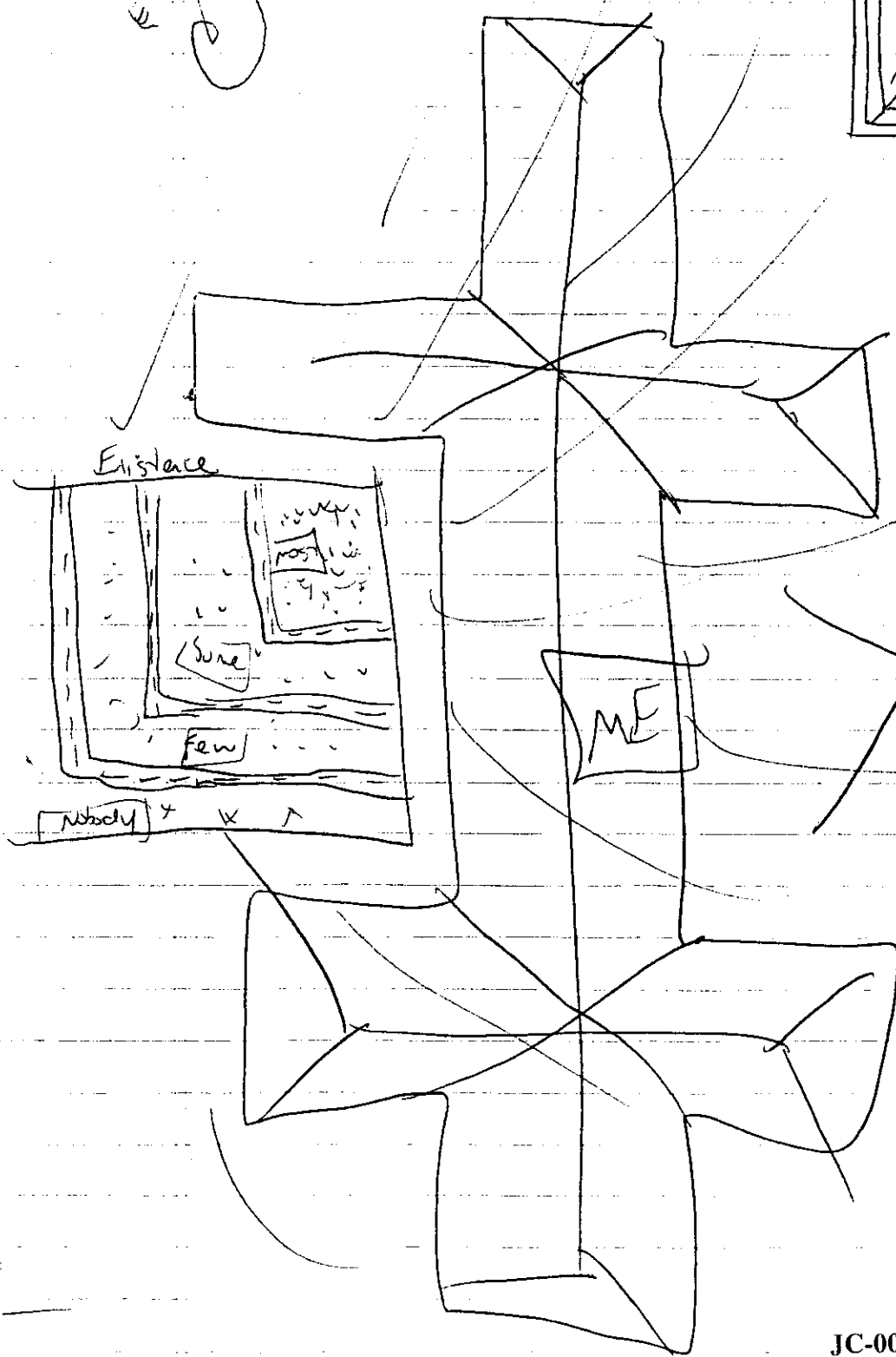
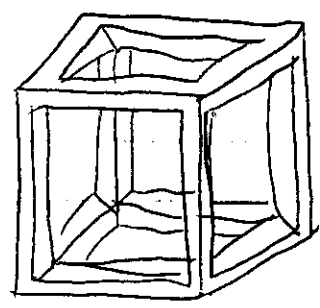

- cut here

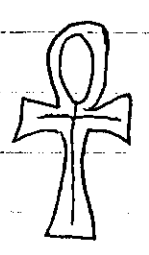

Existence = the box

limitations

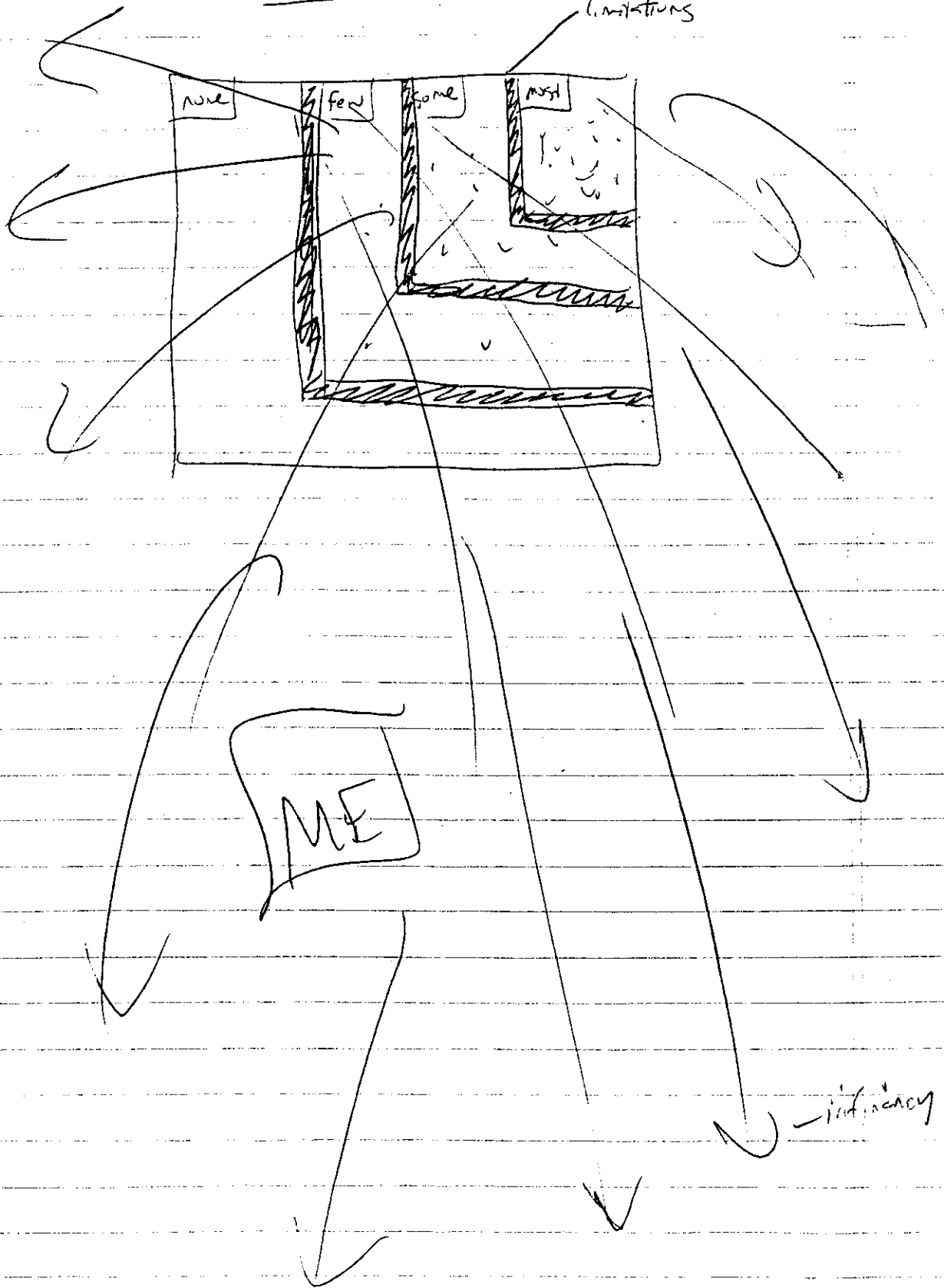

ME

-indeficiency

LC THOUGHTS

W Yes, this is me writing... just writing, nobody technically did anything, just i felt like throwing out my thoughts - this is a weird time, weird life, weird existence. As I sit here (partially drunk w. a screwdriver) i think a lot. Think... Think... that's all my life is, just skillbats of thinking... all the time... my mind never stops... music runs 24/7 (not to sleep) just songs i hear not necessarily good or bad, & thinking... about the asshole [redacted] in gym class, how he worries me, about driving & my family, about friends & things with them, about girls i know (mainly [redacted] & [redacted]) how i know i can never have them, yet i can still dream... I do shit to supposedly 'cleanse' myself in a spiritual, weird sort of way (believing the 'wack' on my camp, not getting drunk for periods of time, & trying not to advocate/make fun of people [redacted] at school, yet it does nothing to help my life - really. my existence is shit. ~~to me~~ to me

thought picture

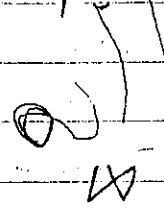

but i feel that i am in eternal suffering, in infinite directions in infinite realities - yet these ~~to~~ realities are like artificial, invented by thought how everything ~~comes~~ ^{comes}, yet it's all

so far apart... & i sit & think... Science is the way to find solutions to everything, right? I still think that, yet i see different views of shit now - like the mind - yet if the mind is viewed scientifically... then I dwell in the past... thinking of good & bad movies

entity

a bit on the past I think we always had a thing for the past - how it reacts to the present & the future - or rather vice versa. I wonder how/when I got so fucked up in my mind, existence, problem - when Dylan Bevet Klebold got covered up by this ~~entity~~ containing Dylan's body... as I see the people at school - some good, some bad - I see you different I am (can't we all you'll say) yet in on such a greater scale of difference than everyone else (as far as I see jocks having fun, friends, women, LIVEZ)

or rather shallow existences compared to mine (maybe) like ignorance = bliss - they don't know beyond this world (how I do in my mind or in reality, or in this existence) yet we each are lacking something that the other possesses - I lack the true human nature that Dylan possessed, & they lack the overdeveloped mind/imaginary/knowledge base. I don't bit in the thinking of suicide gives me hope, that it'll be in my place whenever I go after this life - that it'll finally not be at me in myself, the world, the universe - my mind, body, everywhere, everything is PEACE in me - my soul (existence). & the routine is still monotonous, go to school, be scared & nervous, hoping that people ~~can~~ can accept me... that I can accept them... the NIN song Piggy is good as a thought writing... The last Highway sounds like a voice about me... in gonna write later here - cc-buddha

Dear Thought \leq Year

well well, back at it, yes (you say) ~~whoever~~ the fuck 'you' is, but yes. My life is still fucked, in case you care... maybe... (not?) I have just lost fuckin 45\$, & Rebel that I - lost my zippo & knife - (i did get those back) like the fuck is he being such an ASSHOLE?? (god i guess whoever is the king which controls shit) lets fucking me over big time & it pisses me off. Jook god i HATE my life, i want to die really bad right now - lets see what i have thats good: A nice family, a good house, food, a couple good friends, & possessions, whats bad - no girls (friends or girlfriends), no other friends except a few, nobody accepting me even though i want to be accepted, me doing badly & being intimidated in any & all sports,

Thought
picture

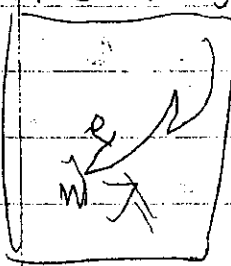

me looking weird & acting shy - BIG problem, me getting bad grades, having no ambition or life, thats the big shit. Anyway... I was Mr. Cutler from M - I have 11

cut

depressioners on my right hand man, & my fav. contrasting symbol, because it is so true & means so much - The battle between good & bad never ends. - OK enough bite him ~~is~~ well im not ~~the~~ done yet. ok go... I dont know what i do wrong with people (mainly women) - its like they are set out to hate & ignore me, i never know what to say or do. ~~is~~ is so fuckin lucky he has no idea how I suffer.

It has some poetry now this is a display
of one man in search of answers, never finding them,
yet in hopelessness understands things...

Existence... what a strange word. He, set
out by determination & curiosity, knows no existence,
knows nothing relevant to himself. The petty deceptions
of others & everything on this world, in this world, he knows
the answers to. Yet they have no purpose to him. He seeks
knowledge of the unthinkable, of the unbelievable, of the
unknown. He explores the everything... using his mind, the
most powerful tool known to him. Not a physical barrier blocking
the limits of exploration, fine then thought thru dimensions...
the everything is his realm. Yet, the more he thinks, hoping
to find answers to his questions, the more come up. Amazingly,
the petty things mean much to him at this time, how he
wants to be normal, not this transceiver of the everything.
Then occurring to him, the answer. How everything is connected
yet separate. By experiencing the petty others' actions,
reactions, emotions, doings, ~~things~~ and thoughts, he sets
a mental picture of what, in his mind, is a cycle.

Existence is a great hall, life is one of the ^{rooms} ~~rooms~~, death
is passing thru the doors, & the ever-resistant compulsion of
everything is the curiosity to keep moving down the hall, thru
the doors, exploring rooms, down this never-ending hall. Questions
make answers, answers create questions and at long last he is content ←
ITYL CC-VODKA →

Thought

You... whassup... ldehhehe... Know what
~~the~~ mind? Everyone knows revelation - I swear -
like in an outkast, & everyone is conspiring against
me... Check it... (this is not good, but need to write
so here...)

Within the known limits of time...
within the conceived boundaries of space...
the average human thinks these are the settings
of existence... Yet the ponderer, the outkast, the
believer, helps out the ~~rest~~ human. "Think not of
2 dimensions" says the ponderer, "but of 3, as your
world is conceived of 3 dimensions, so is mine. While
you explore the immediate physical boundaries of your
body, you see in your 3 dimensions - L, W, & H. Yet I,
who is more mentally open to anything, see my 3
dimensions - my realm of thought - Time, Space, & THOUGHT
Thought is the most powerful thing that exists - anything
conceivable can be produced anything & everything is
possible, even in your physical world." After this so
called "lecture" the common man feels confused, empty,
& unaware. Yet, ~~these are~~ ^{these are} the best emotions of a ponderer.
The real difference is, a true ponderer will explore these emotions &
batter in a dream. what ~~they~~ caused
them.

Miles & miles of never ending grass, like a
wheat. A forest, sunshine, a happy feeling in the presence,
Absolutely nothing wrong, nothing ever is contrary 180°
to normal life. No awareness, just pure bliss,
unexplainable bliss, the only challenges are no challenge,
& then... ~~BAM!~~ realization sets in, the world is the greatest
amusement. life

Hypnosis place - It is a sky - with one large cloud,
& sort of a cloud made chair - the sun is at the
head of the chair - 10 o'clock - up into the sky ...

Below, I sometimes see myself & the green (Forest green)
earth - sorta a city, yet I hear nothing. I relax on
this chair - actually like a chaise - & I am talking ...
to what? I don't know - it's just there, I have
the feeling that I know him, even though I consciously
don't, & we talk like we are the same person -
He has my soul ...

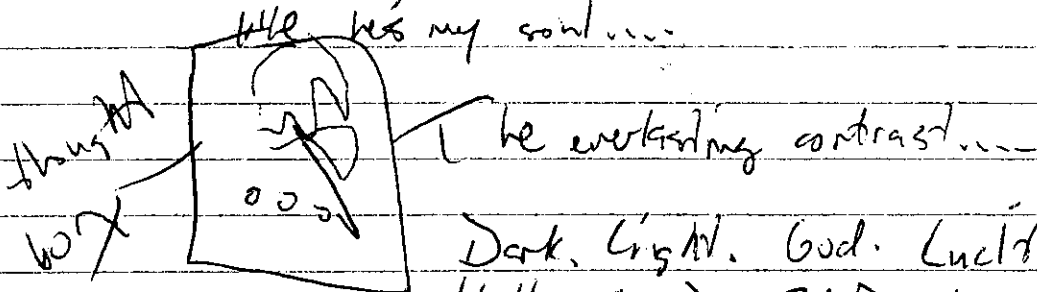

Dark, Light, Good, Lucifer, Heaven,
Hell, GOOD, BAD. Yes, the ever-lasting
contrast. Since existence has known
the 'fight' between good & evil has continued.
Obviously, this fight can never end. Good things
turn bad, bad things become good, the 'people' on
the earth see it as a battle they can win. HA
Such is morose. To people looked at history they would
see what happens. I think too much, I understand,
I am GOOD compared to some of those irresistible
brainless zombies. Yet, the actions of them interest
me, like a kid w. a new toy. Another contrast, more
of a ~~paradox~~ paradox, actually, like the advanced go far
the undeveloped's realm, while some of the morose become
everything dwellers - but, exceptions to every rule, & this IS
a BIG exception - most morose never change - they never
decide to live in the 'everything' frame of mind!

←-VODKA-→ is thought

7-23-91
A drinking
time

The [redacted] situation

It is not good for me right now (like it
ever is) ... but anyway ... My best friend
ever: the friend who shared experiences, laughed,
took chances with & appreciated me more than
any friend ever did has been ordained ... "passed
on" ... in my back. Ever since [redacted] (who I wouldn't
mind killing) has loved him ... that's the only place
has been with her ... I'd suppose had any idea
how sad I am ... I mean we were the TEAM
when him & I first were friendly, well I
finally found someone who was like me:
who appreciated me & shared very common
interests, Ever since 7th grade I've felt
lonely ... when [redacted] came around, I finally
felt happiness (sometimes) ... we did cigars, drinking,
suburbs to houses, EVERYTHING for the
first time together & now that he's "passed on"
I feel so lonely, w/o a friend. Oh well, maybe
he'll come around. → I hope.

Book

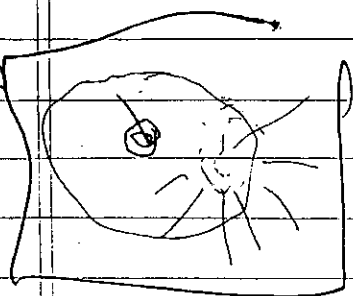

→ for this topic
That's All ... maybe I'll
reverse this again ...

^
O = [redacted] = C
←-VODKA-→

My first love!!!

Oh My God... I am almost sure
I am in love with ~~_____~~ Hehehe...
such ~~of~~ a strange name, like mine... Yes everything
about her I love. From her good body to her
& Almost perfect face, her charm, her wit
& knowing her NOT Being popular, Her friends
(who I know) - some - I just hope she likes
me as much as I ~~LOVE~~ LOVE her. I think
of her every second of every day. I want
to be with her. I imagine me & her doing
things together, the sound of her laugh, I
picture her face, I love her. ~~It's~~
soulmates exist, than I think I've found
~~mine~~ mine. I hope she likes Techno... :-)

~~_____~~

I love you

Dylan

my thoughts

and god i want to die soon bad... such a sad, desolate, lonely, un salvageable i feel ~~like~~ i am... not fair, NOT FAIR ALL
 damn I wanted happiness!! I never got it...
 let's sum up my life... the most miserable existence in the history of time... My best friend has ditched me forever, but in bettering himself & having /enjoying/ taking for granted his love... HE NEVER knew this... not too times near this... they look at me [redacted] like im a stranger... I helped them both out thru life, & they left me in the abyss of suffering when i gave them the boat out. The one who I thought was my true love, [redacted] is not. Such a shell of what i want the most... The nearest trick was played on me - a fake love... she in reality doesn't give a good fuck about me... doesn't even know me... I have no happiness, no ambitions, no friends, & no LOVE!!! [redacted] can get me that gun I hope, i wanna use it on a poof SOB. I know... his name is vodka, dylan is his name too. What else can I do/give... i stopped the pornography I try not to pick on people, obviously at least one power is against me. [redacted]... funny how I've been thinking about her over the last few days... giving myself fake realities that she, others MIGHT have liked me just a bit... my bad i have always been hated, by everyone & everything, just now more... Goodbye all the crusts i've ever had, just shells, images, no ~~is~~ truths... BUT

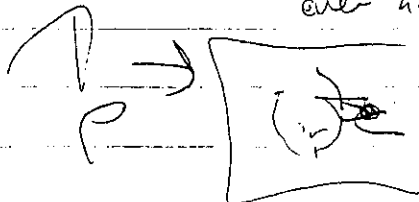
 WHY? YES YOU CAN NEED!
 THIS, WHY DID YOU SWAN
 [scribbles]

A dark time, infinite sadness, I want to find love.

Ignorance is bliss

happiness is ambition

desolation is knowledge

pain is acceptance

despair is anger

denial is helplessness

martyrdom is hope for others

advantages ^{taken} are causes of martyrdom

revenge is sorrow

death is a reprieve

life is a punishment

others' ~~own~~ achievements are tormentations

people are alike

i am different.

- Dylan

me is a god, a god of sadness

exiled to this eternal hell

the people i helped, abandon me

i am denied what i want,

to love & to be happy

being made a human

without the possibility of BETTER human

the smallest of all punishments

to some, i am crazy

it is so clear, yet so foggy

everything's connected, separated

i am the only interpreter of this

i'd rather have nothing than be nothing

some say godliness isn't nothing

humanity is the something i long for

i just want something i can never have

The story of my existence. - Dylan

(sadly,
sorry to everyone...
i just can't take it...
all the things...
to many...
heart this...
i must have happiness,
love, peace,
goodbye

fuck that → ~~me~~
me
10-14-01
fuck ev.

Thou's Am

Me, sorry i didn't write, A SHITLOAD in my instance mind.
ok hell & back... i've been to the zombie bliss side... &
I hate it as much if not more than the mereless part.
I'm back now... a taste of what I thought i want...
wrong. Possible girlfriends are coming from [redacted]...
ill give the play shit up in a second. want TRUE
love... I just want something i can never have... true love
I hate everything, why cant i die... not fair. I want
pure bliss... to be cuddling w/ [redacted] who i think i love
deeper than ever... I was wrong, thought i was right. another
form of the Downward Spiral - deeper & deeper it goes,
to candle w/ her - to be w/ her, to love, just laying
there. I need a sign. This is a weird entry, i
should feel happy but shit brought me

down. I feel terrible. The lost Highway
apparently repeats itself. I want drink.
now [redacted] lucky bastard gets a
perfect soulmate, who he can admit

FUCKIN SUICIDE to. & I got rejected for being
bored about fuckin love for weeks. From the wrong people
never... [redacted] & [redacted] Anyway... theres a
2 parts.

~~FUCK~~
me
me

Awareness signs the warrant for suffering. Why is it that
the zombies achieve something me wants (over-developed me).

They can love, why can't I? The true existence lies in
solitude, always aware, always infinite, always looking for,
his love. Peace might be the ultimate destination.

Destination unknown... inward happiness. Abandonment is
present for the martyr. My thoughts ~~it~~ ^{it's} in want to
~~stay~~ ^{live} in. I want to find a room in the great hall &
stay there in my love & never. Sadness seems infinite,
& the spark of happiness shines around. Yet the true
despair overcomes in this lifetime. How tragic too my

Religion Dumass still need

photo of it not broken in

godson peek at dead
at end of water
hand on the wall

Religion
PWA

No emotions, not caring.

yet another stage in this
shit like suicide... PWA lol

this
11-3-9,
Fuck all

That

Father & father dist... That whats happenin
me & everything that zombies consider real... just
images, not life. Soon i will ~~leave~~ ^{be in} place i hope
Burn → with all your life sucked up around you... I get more
depressed with each day, if more exist... but ~~can't~~ ~~stop~~
stop, go!!

Some sodi am... All people i ever might have loved
have abandoned me, my parents piss me off & hate me
want me to have fuckin ambition!! How can i when
i get screened & destroyed By everything!!
I have no money, no happiness, no friends, Eric will
be getting brother away soon... I'll have less than nothing
... how normal I wanted to love... i wanted to be happy
and ambitious and free & nice & good & ignorant...
everyone abandoned me... i have small stupid pleasures,
my so called hobbies & doings... those are all that's
left to me... Reliving onto the smallest rocks... many



people climbing up a never ending vertical cliff
and a plankton to exist on... they
walked up me to get bit. Nobody will help me...
only exist w. me if it suits them. i helped, why can't
they? will get me a gun, ill go on my killing
spree against anyone I want, more crazy... deeper in the
spiral lost highway repeating, dwelling on the beautiful
past, (& gettin drunk) w. more, everyone moves on
i always ~~stayed~~ stayed. Abandonment. this room snx. wand
die

everything is as least expected, the weak are trampled on, the assholes prevail, the ~~sapient~~ gods are deceiving, lost in my little insane asylum w. the ambulance redneck music playing... wanna die & be free w. my love... if she ever exists. She probably hates me... bitchy nazi/cee or a jock who treats her like shit. I remember details... nothing worth remembering i remember. I don't know my love; could be [redacted] or [redacted] or [redacted] or [redacted], or anyone. I don't know & i'm stuck in the dark - is up with me!!

I have lost my emotions... like in heart the song. N/A. People eventually find happiness, i never will. Does that make me a non-human? YES. the god of sadness... [redacted] church was so funny the rec thing w. [redacted] [redacted] [redacted]

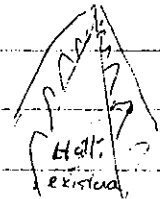
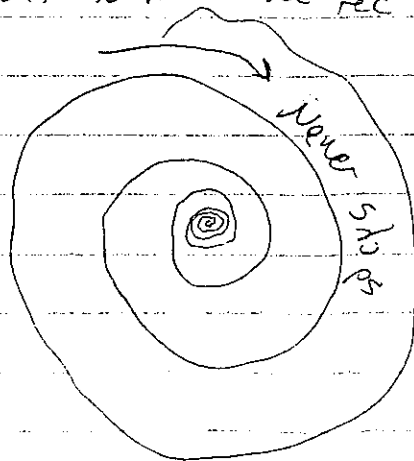
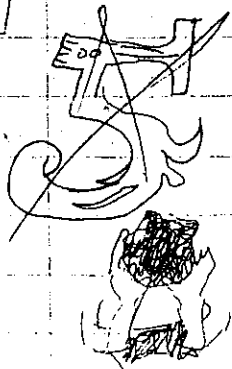

no, everything (no, everything) ever thing

1-2-98

oo... Beer... Man is about
know what's up lately... new do in existence. All this
shit in [redacted] & [redacted] grounds... so weird & different
from past... yet again, that's the way in existence.
I wonder if I'll ever have a love... my love [redacted]
got his, i don't, wonder get mine. There's all the people
i've loved, or at least liked (or thought i loved) - all the same
meaning.

[Large redacted section]



[redacted] is the newest... the present
(for now)... seems perfect for me...
I seem perfect for her. I was delusional
& thought she would cut me the last day
of school. Oh well... my emotions are gone
so much past pain alone my
senses are numbed. The beauty
of being numb... Let's

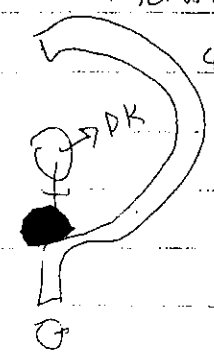

one of my symbols → ○

Everything $\left\{ \begin{array}{l} \text{No, everything} \\ \text{No, everything} \end{array} \right.$
Everything $\left\{ \begin{array}{l} \text{No, everything} \\ \text{No, everything} \end{array} \right.$
Everything $\left\{ \begin{array}{l} \text{No, everything} \\ \text{No, everything} \end{array} \right.$
Everything $\left\{ \begin{array}{l} \text{No, everything} \\ \text{No, everything} \end{array} \right.$

The cliff theory... everyone
trying to get higher & stable...

I
2-2-99
the enough

Existence... to understand

well well... so much changes... (like existence)

I understand almost everything now... so close to my love -

The ones have shown it, she has shown it, I have felt it. I know the meaning of each life. To

be loved by your love, & to be happy in ones self. Only

for the gods though (me, [redacted], etc.) The zombies

& their society had together & try to destroy what

is superior & what they don't understand & are afraid

of. Soon... either ill commit suicide, or ill get in

[redacted] & it will be NSK for us. My happiness, her

happiness. NOTHING else matters. I've been caught

in most of my crimes - xpl drinking, smoking, & the house

vandalism & the pipe bombs. I'd, by fate's choice,

[redacted] didn't love me, id slit my wrist & blow up a/lotta

strapped to my neck. It's good, understanding

a hard road since my realization, but it gets

easier. BUT IT DOESN'T! That's part of

~~the~~ existence. Unpredictable. Existence is pure

well & pure beauty at the ~~same~~ same time. I will never

stop wondering, the best highway will never end, the music in

my head will never stop... take all part of existence. The hell

will never end. The love will always be there. (Go)

TB
→

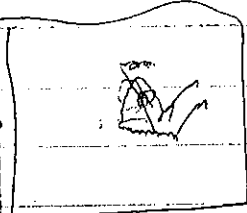

BE LOVE HERE!! - it's so good to be

Society is tightening its grip on me, & soon I & [redacted] will snap. We will have our revenge on Society, & then be free to exist in a timeless, spaceless place of pure happiness. The purpose of ~~life~~ ^{life} is to be happy & be w/ your love who is equally happy. Not much more to say. Goodbye

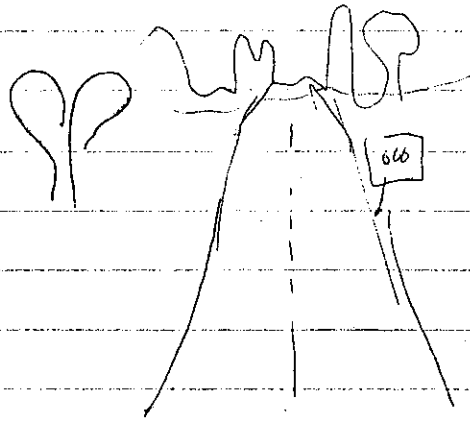

~~At~~ Almost happiness is slavery - be rich, people (gods) are slaves to the majority of zombies, but we know & love being superior.

I didn't want to be a jerk... I wanted the happiness that they have - & I will have something infinitely better...

I love
her, & she loves
me

(By the way, some zombies are smarter than others, some manipulate... like my parents.)

I am God [redacted] is God
& zombies will pay for their arrogance, hate, fear, abandonment, & distrust

I think about anyone in I know that this
 humanity is almost over that we will be free
 we have parents & family that we are the everything
 of purity & halcyon, & that we deserve, need,
 love, and exist w/o each other. it's hard, i think
 that i might not be enough, my mind sometimes
 sets itself on its own things, i think about
 human things. All i try to do is imagine
 the happiness between us. that is something
 we cannot even conceive in this tainted earth.
 The everything, the halcyon, the happiness is ours.
 There will be no notes from me. Let the humans
 suffer w/o my knowledge of the everything.



I am trying not to think about
 the happiness, somehow thinking that
~~it~~ will destroy it if i become
 reliant into what i'm a human.

But i love her. we are soulmates,

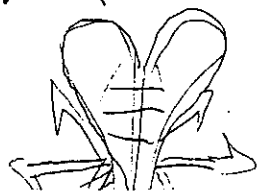

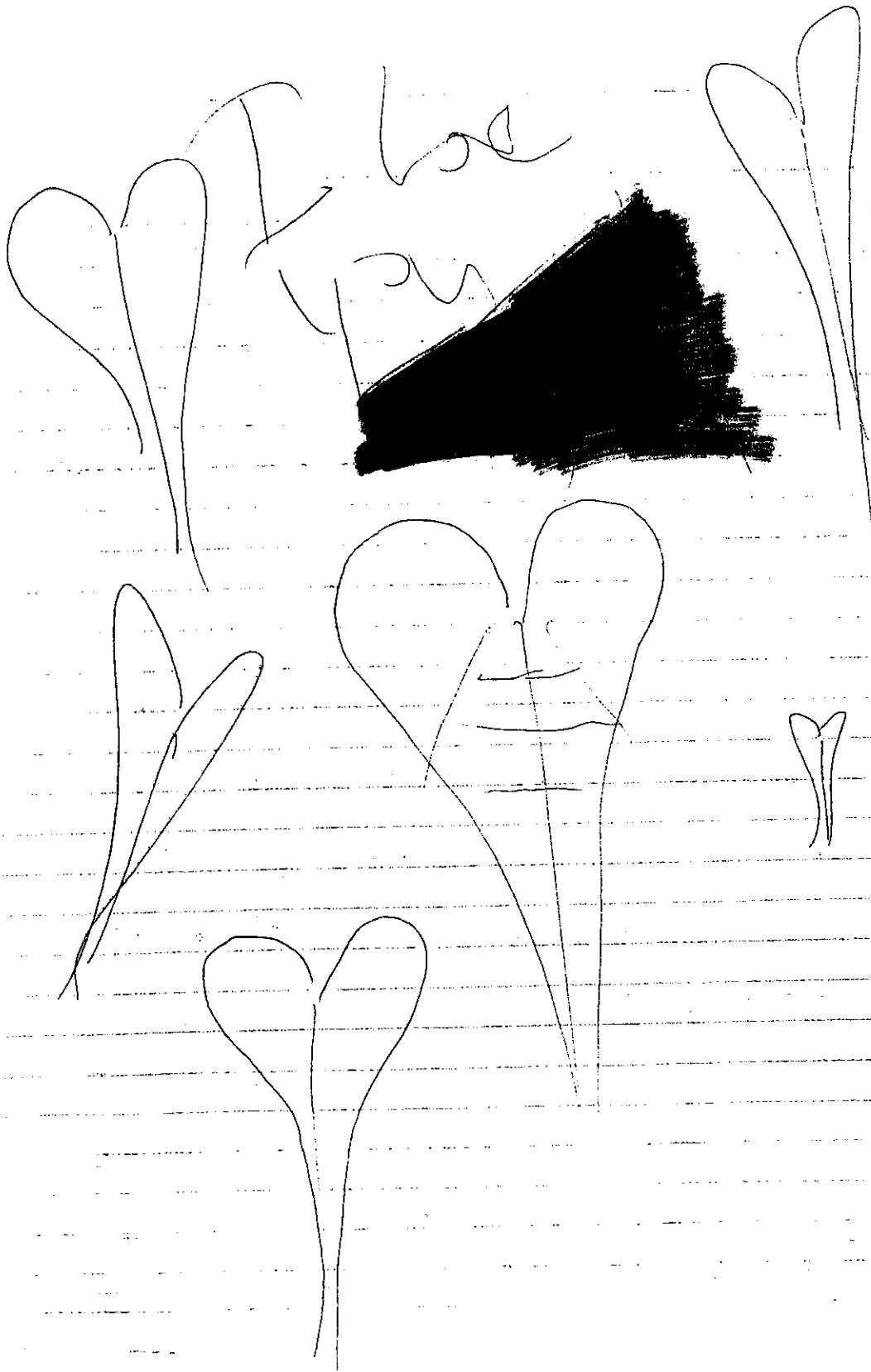

JC-001-026407

(Please don't skip to the back
read the note as it was
written)

~~_____~~
You don't consciously know who I am, & doubtlessly
unconsciously too. I, who write this, love you beyond infinity.
I think about you all the time, how this world would be
a better place ~~if~~ if you loved me as I do you.
I know what you're thinking: "some psycho wrote me
this harrasing letter" I hoped we could have been
together... you seem a bit like me. Pensive, quiet, an
observer, not wanting what is offered here (school, life, etc.)
You almost seem lonely, like me. You probably have a
boyfriend though, & might not have since this note another
thought. I have thought you my true love for a long time
now, ~~but~~ but... well... there was hesitation. You see I
can't tell if you think of anyone as I do you, & if you
did who that would be. Fate put me in reach of you,
yet this earth blocked that with uncertainties. I will
go away soon, but I just had to write this to you,
the ~~one~~ one I truly loved. Please, for my sake, don't

It is solely
my
decision:
nobody else's.

tell anybody about this, as it was only meant for you.
Also, please don't feel any guilt about my soon-to-be
"absense" of this world. Oh... the ~~the~~ thoughts of ~~us~~ us...
doing everything together, not necessarily anything, just to
be together would have been pure ^{heaven} ~~heaven~~. I guess it's
time ~~to~~ to tell you who I am. I was in a class with you
1st semester, & was blessed w. being with you in
a ^{report} ~~report~~. I still ^{remember} ~~remember~~ your laugh. Innocent, beautiful, pure.
This semester I still see you - ^{rarely} ~~rarely~~. I am ~~at~~ ^{entrance} entrance

during 5th period, as we both have it off. To most people, I appear ^{now} well... almost scary, but that's who I ^{appear to be} ~~am~~. ^{as peopl} ~~am~~ ^{are afraid} ~~am~~ ^{of what th} ~~am~~ ^{don't} ~~am~~ ^{understan} ~~am~~ who I was for a long time. until high school...
 Anyway, you have noticed me a few times, I catch every one of these gazes w/ an open heart. I think you know who I am by ~~now~~ ^{now}. Unfortunately... ~~you~~ ^{even} if you did like me even the slightest bit, you would ~~hate~~ ^{hate} me if you knew who I was. I am a criminal, I have done things that almost nobody would ever think about condoning. The ~~reason~~ ^{reason} that I'm writing you now is that I have been caught for the crimes I committed & I ~~want~~ ^{want} to go to a new existence. You know what I mean. (Suicide \odot) I ~~have~~ ^{have} nothing to live for, & I won't be able to survive in this world after this legal conviction. ~~However~~ ^{However}, if it was true that you loved me as I do you, I would find a way to survive. Anything to be with you. 99/100 chances you prob. think I'm crazy, & want to stay as far away as possible. If that's the case, then I'm very sorry for involving an innocent person in my problems, & please don't think twice. ^{combos = 19-37} However, if you are ~~me~~ who I hoped for in my ~~dreams~~ ^{dreams} & ~~realities~~ ^{realities}, then do ~~me~~ a favor: ^{leave} ~~leave~~ a piece of paper in my locker, saying ^{#857} anything that comes to you. Well, I ~~guess~~ ^{guess} this is it - goodbye, ^{near the library} & I love(d) you.

I would enjoy life knowing that you loved me.

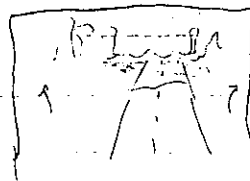
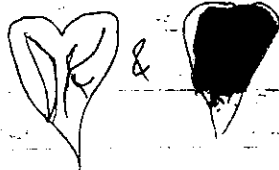

Alan Tebol



6898



our Hakeyon

I LOVE

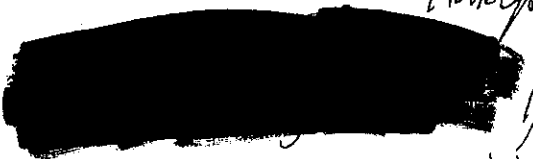

I love her to infinity
to look back on my awareness journey, see the
paths & relations of my understanding --- it's
almost done, yet it is never done, I love

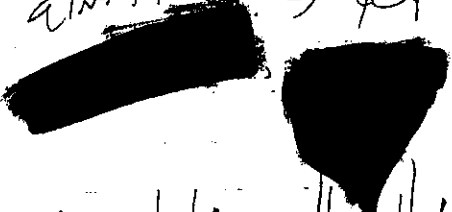

She is my soulmate,
my bliss, all the imaginative Hakeyons
& pure existences I have with her (to me)
are almost happiness --- I wish with I could

call her --- something blocks me from calling
her my time side is putting up a wall
to prevent me from calling her, like a son
of a bitch "truth" ~~PS~~, I will overcome

all fears, doubts, & zombie-based thoughts
(expression) --- I will follow on heads
to the Hakeyon, loving her. I love you





JC-001-026411

Forever Fall, up & down spiral

me
6-10 -98
i think
don't call

1.5 human years... so much changed in small time, my friends (at my choice) are depleting & all spring under each other (Eric & [redacted]) like i thought they would, I am ready to be in [redacted] The ups & downs of fate are forever, good & bad, equal me. \neq the lost highway, & downward spiral never end. existence is like infinity times itself. ∞ I have passed this much of the ever existence this is almost a checkpoint the zombies have set their place in my mind. for the

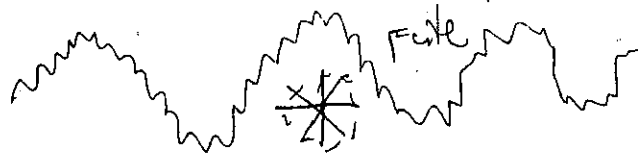

diff theory, the jumped off us

[redacted] & we've shocked away to the helix on the zombies will pay for their being, ~~then~~ their hearts. I know everything, yet I know nothing I am a true god, my infinite memories, thoughts, perceptions of purity come a lot more u. u. u. there is pure happiness - the ~~purpose~~ purpose of ~~our~~ our existence. I hate, love things hate everything, love me & [redacted]

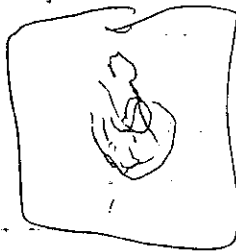

I understand that I can never ever be a zombie, even if i wanted to. the nature of my entity. Soon we will live in the helix of our minds, the one thing that made me a god. Things are so simple, now that they are infinitely complicated. ∞

I understand

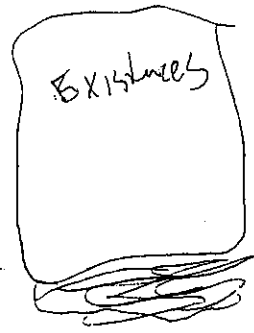

whether of the mystery
of the God
of the mystery

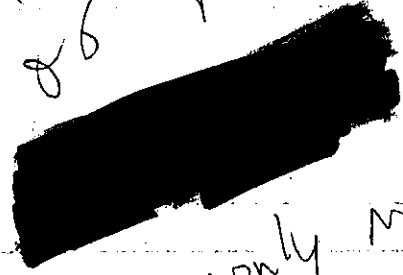
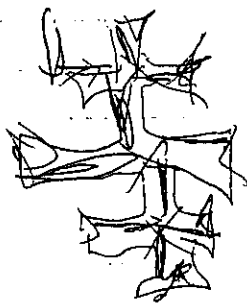

Existence
books

ate is my only need

sp

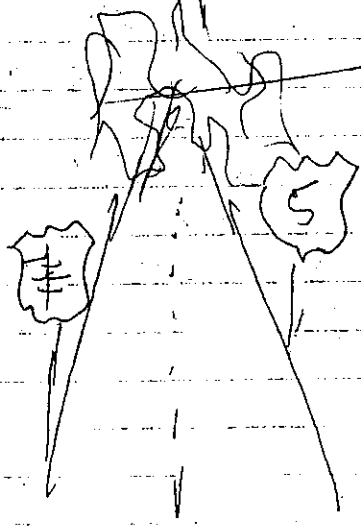

This is prob. my last
entry. I have many
self love sound to
[redacted] my everlasting
life. goodbye

Dullness
stop
learning

Dylan
1-20-99

TRUS SWT

This shit again, sack of shit, doing just like
 a fucking comb. Lately I ~~can~~ can change my
 mind from the fucking deeds of zombies - Earth,
 humanity, HERE, that's ~~the~~ mostly what I think
 about. I hope ~~to~~ to I want to be free, in free in
 thought it would have been time by now, the pain
 multiplies infinitely, never stops. (yet (is?)) in here,
 STILL above, still in pain, so is she. The thing
 I have concluded is that ~~she~~ ~~is~~ will decide when
 we should be together. ~~is~~ decided when our existence
 started, it should end the same way, with us
 unknown, in limbo. I love you ~~██████████~~ Always here, will.
 The scenarios, images, pieces of happiness still come.
 They always will. I love her she loves me. I know
 she is tired of suffering as I am, it is time, it is time.
 I love her the journey, the endless journey started
 it has to end. we need to be happy to exist timely.
 I see her in perfection, the holy ones, I am it, endless
 purity. I exist as less than nothing to be - O.
 my humanity, - O, I don't know if I should call her,
 or wait for ~~her~~ ~~to~~ to act. Yet calling her is
 a shade of humanity. I'm forever sorry, invidely,
 about the poems. My humanity has a foot fetterish
 of bondage, extreme liking. I try to throw it, sometimes
 to no effect. Yet the masturbation has stopped. I'm sorry
~~██████████~~ always. I feel the happiness here, thinking
 of her, for brief moments. That's how I know the everything
 is true.

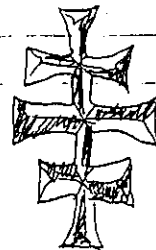
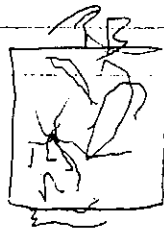

I hate
this non
thinking stasis.
I'm stuck in
humanity. maybe
being "NRK" (god)
w. eric is the
way to break free.
i hate this.

Love
you.

The weather
is a replication
of our thoughts.
The happiness is
possibly imminent.
I mean ~~you~~

The happiness is close
visible ending end of
the beginning of the
halcyons.

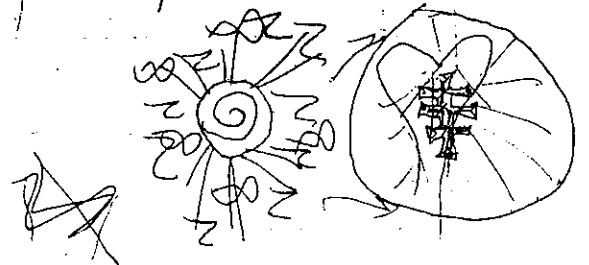

The humanity is blocking me again. Time to
go. Haha hahaha suck off. hah this shit need
to be over, well ok, love her. ~~percept~~ ♡

The framework of society stands above & below me. The hardest thing to destroy, yet the weakest thing that exists. I know that I am different, yet I am afraid to tell the society. The possible abandonment, persecution is not something I want to face, yet it is so primitive to me. I guess being yourself means letting people know about inner thoughts too, not just opinions & fashions. (checked) I will be free one day, in the land of purity & my happiness, I will have a love, someone who is me in anyway. Someday... Possibly thru this life, maybe another, but it will happen.

Love is more valuable than anything I know. To
love is to enter a completion of oneself.
I hate those who choose to destroy a love, who
take it for granted. Love is greater than life ever.
As I look for love, I feel I can't find it, ever, but
something tells me I will, someday, somewhere. As
my love will find me. She feels as I do right now,
I can feel it, we will be inseparable, Her & I.
Whether ~~it~~ it is ~~or not~~ or not, I think I'll find it.
(my love). We will be free, to explore the vast wonders
of the stars. To cascade down everlong waterfalls &
then the warmest seas of pure happiness. no limits, ...
no limits. Nothing will stop us.

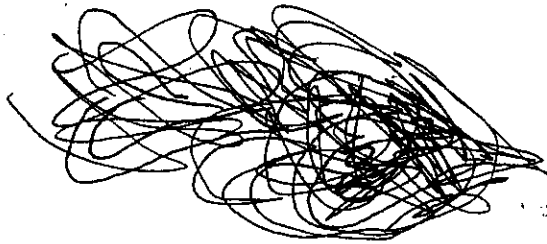

Pages

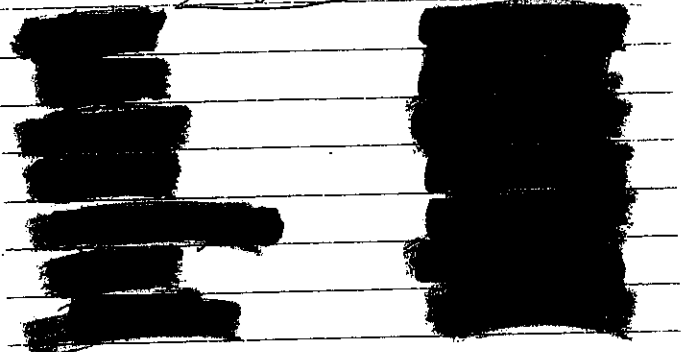

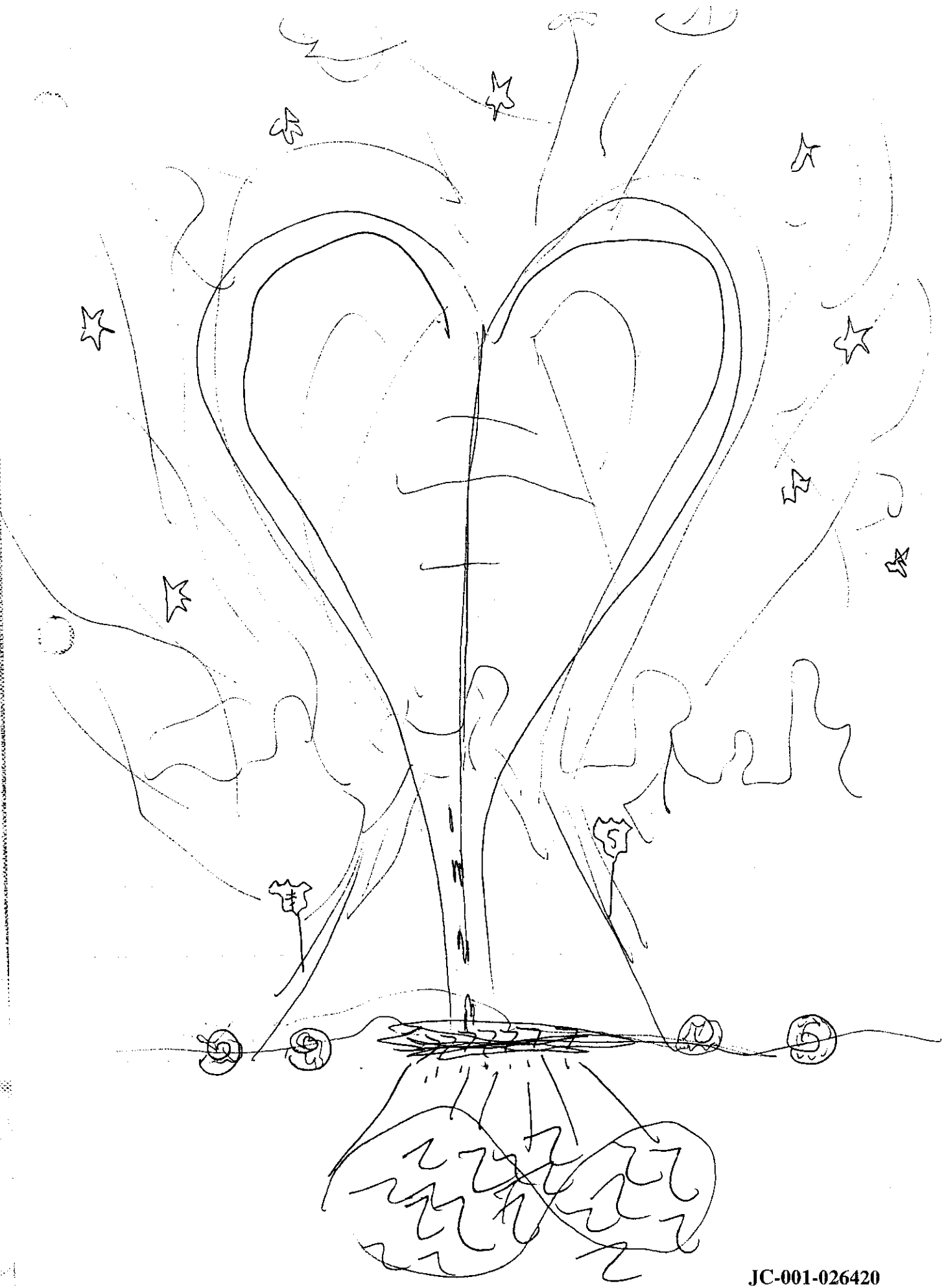

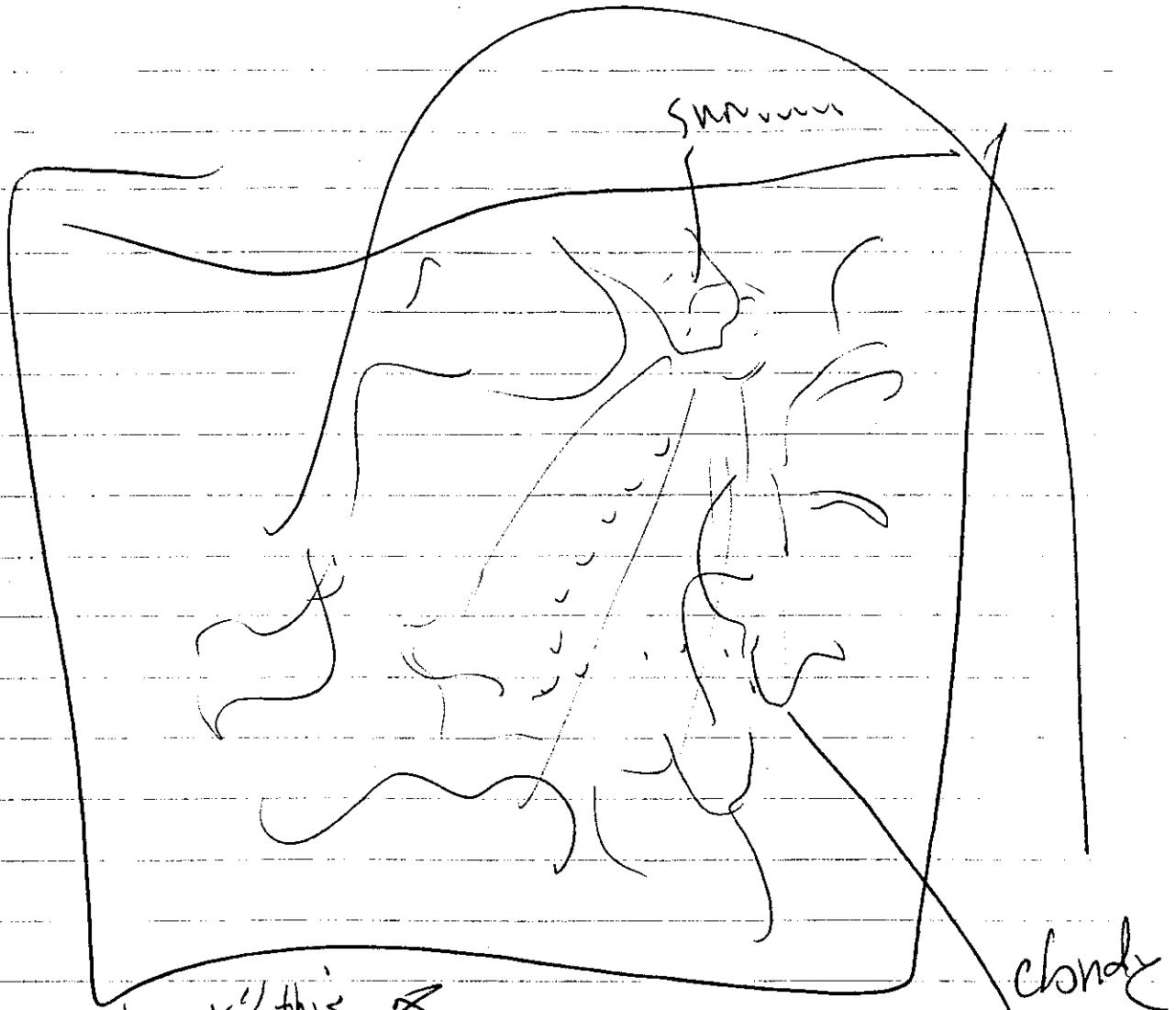

cloudy

everyone else w/ this
book cannot be opened,
some supernatural force
blocks it to common
people

everything

Sucking
in

Existences

By Dylan

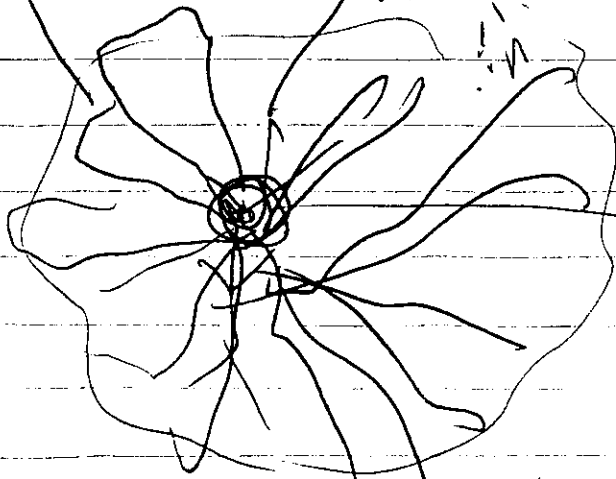

JC-001-026421

letting
go

I know its
never anything

is true...
my love is
gone.

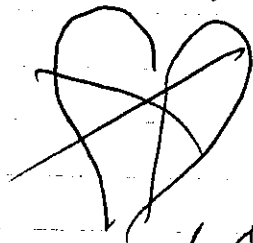

love

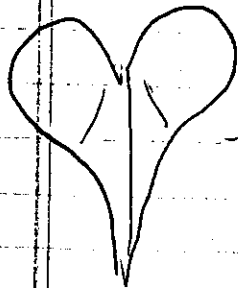
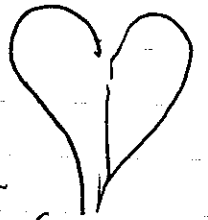

existence for
over 13 the
happiness that
we have achieved
in our lives

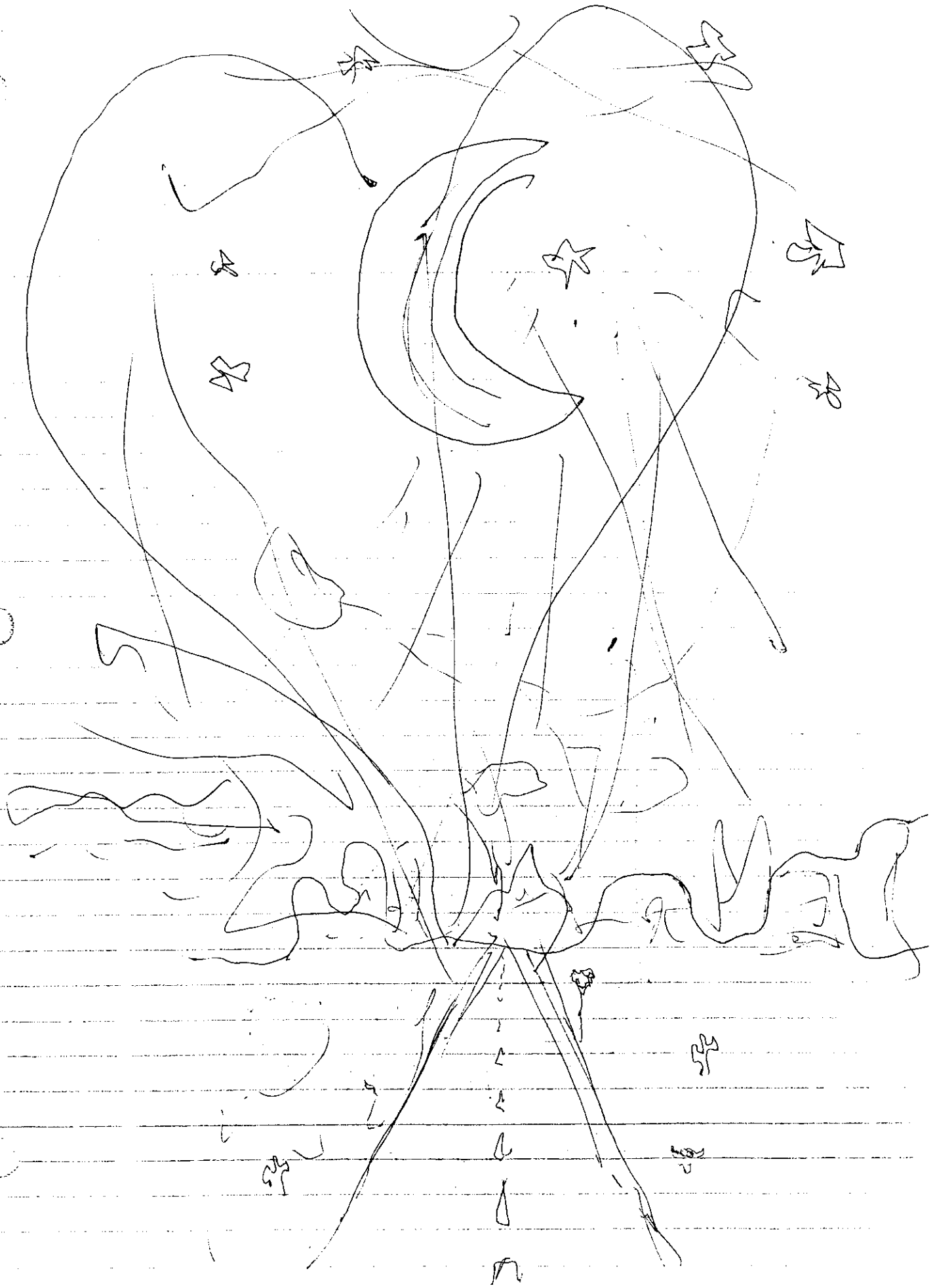

JC-001-026423

I now know the final
battle - the pain of
humanity is overcome

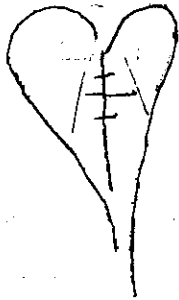

I love
you

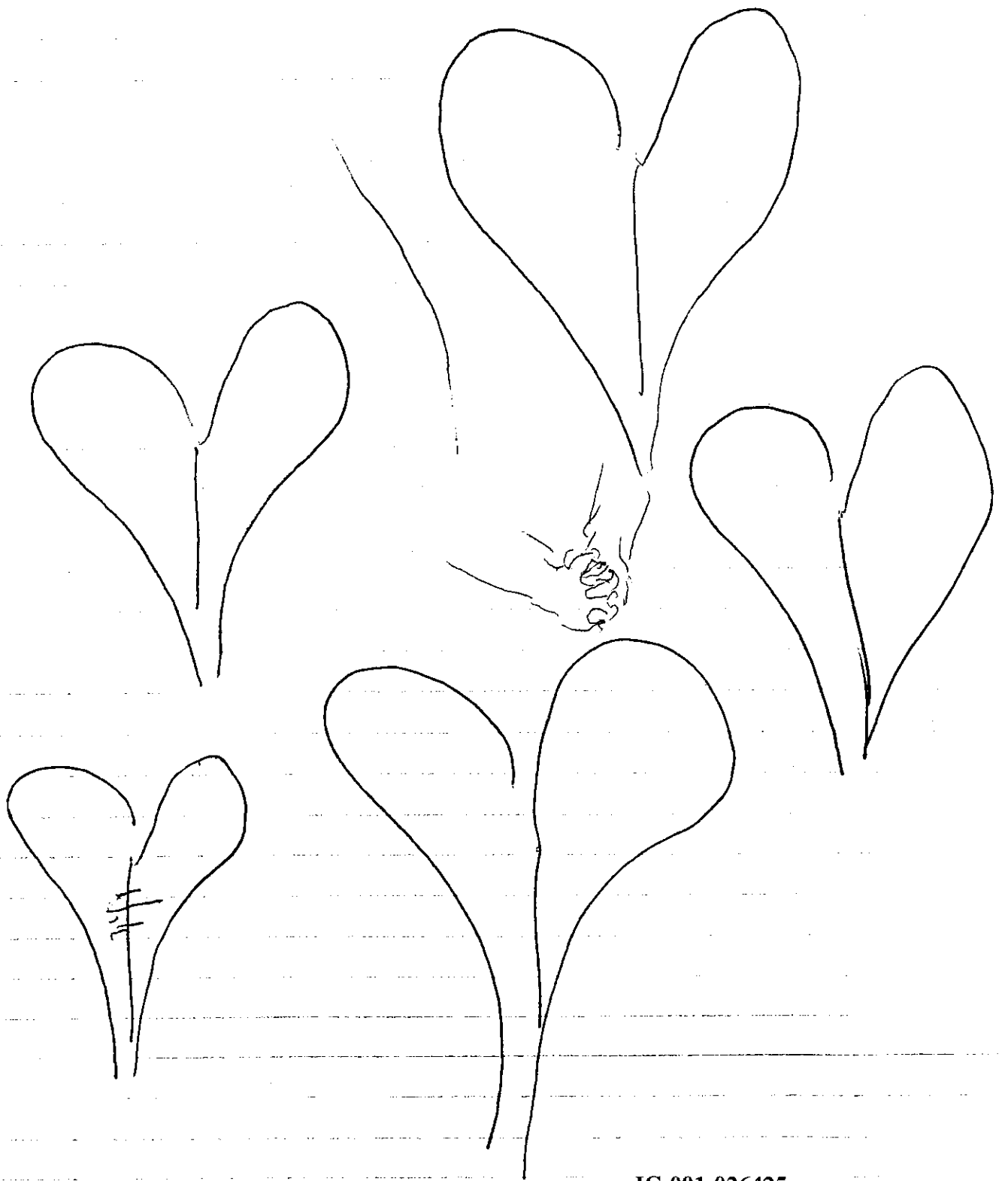

JC-001-026425

[redacted] is for the [redacted] joy
she gives me

[redacted] is for ~~the~~ how she [redacted]
is helpless with her beautiful
gaze.

[redacted] is for the ~~the~~ [redacted]
moments ~~the~~ she shares w me

[redacted] is for the [redacted] bond
love that we been looking for
g4 my life

[redacted] ~~is for the~~ is the [redacted]
of us as a couple.

[redacted] How [redacted] I hope
[redacted] is
spend time with her

[redacted] how she is the [redacted]
one i love that i have ever found

[redacted] ~~is for~~ is for
the [redacted] here we can
look at the stars

[redacted] how [redacted] beautiful
she is

[redacted] her [redacted] for everything
she does

To my love:

As a man, a conqueror, does his deeds of
greatness, he thinks he is complete. Yet the true
great reason achieves happiness only when he
has met ~~the~~ his soulmate.
Alone unknown until the first time they lay
eyes and hearts. A true love is hard to come
by, yet the most fulfilling, beautiful, completing
achievement any man can have. Some have wealth,
Some have power. Some have great intellect, yet, keep
an infant # of times greater than those who
have found My true love.

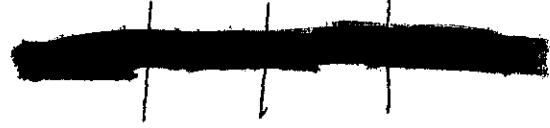

Real CC use Br CD player

Union Bank Mastercard

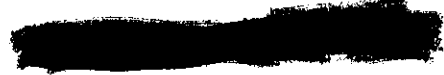

RE/MAX Professionals, Inc. — Broker/Owner
8500 W. Bowles Ave. — Littleton, CO 80123
Office (303) 973-3313

JC-001-026428



Standard 8-97
Discard card

**BUYING OR SELLING A HOME?
CALL RANDY BROWN (303) 973-1380**

Broker Since 1980
G.R.I. Since 1980
C.R.S. Since 1983
Construction Expert
State Registered Appraiser
RANDY BROWN REAL ESTATE INC.



Independent Companies
Working Together

RT

VICE®

5248-01
Master
Union Ins.
Business cert: 6-98
2437602528
abroad-active

http://www.islandnet.com/~~www~~
ccaird/doom/
http://www.cs.ucl.ac.uk/stud
~~http://www.cs.ucl.ac.uk/~~
students/zcacaes/mk.html

http://www.playboy.com/
" " .penthousemag.com/
" espnet.sportszone.com/
" wcl-rs.bham.ac.uk/
" GamesDomain/
" calvin.hsc.colorado.edu/

sp
sparkie-riv.net/fetish/
magazine/sex_surf.htm

307-235-3916
USWEST station

http://beehive.twis.com/vladimir/mac.html

ftp://prime.net.com/users/c/cracked/cracking/password/password.exe

ftp://ftp.fc.net/pub/defcon/SATAN/

GUBHHBRI EP4UJSEFF
VBASTBIJ
ENRG26VM
SPQVOC
HSMALCDB
HRUGLJVV

All disks of Dadriev
-stuff TOS, ZIP guide
All Drivers (key stick, mouse, cd, etc.)
Netscape AOL setup
Win 95 XCom
Doom Gurus
Doom 2 Full Throttle
Vocetic wars
Wren Tfight
POTT
CWS2
Snake
Duke
Hackz
VBasic

<http://ftp.cdrom.com/pub/idgames2/quakec/weapons/grab1096.zip>

~~SECRET~~ 23
1
<Ahref="col:2719:z-z-
coldice"> zipperz
8m79 off ut "!!" regn.
1195072 2p.m. 2JWZSNX7

~~ES~~

TOS

Asbomer - all CAMEERZ die!
Sto - mfront - The END is an

Frame

<http://stsim.com/mdc/hidpic>

"Mentor's Last Words"

courtesy of the Jolly Roger

The following file is being reprinted in honor and sympathy for the many phreaks and hackers that have been busted recently by the Secret Service.

 \/\The Conscience of a Hacker/\

Another one got caught today, it's all over the papers. "Teenager Arrested in Computer Crime Scandal", "Hacker Arrested after Bank Tampering"... Damn kids. They're all alike. But did you, in your three-piece psychology and 1950's technobrain, ever take a look behind the eyes of the hacker? Did you ever wonder what made him tick, what forces shaped him, what may have molded him? I am a hacker, enter my world... Mine is a world that begins with school... I'm smarter than most of the other kids, this crap they teach us bores me... Damn underachiever. They're all alike. I'm in junior high or high school. I've listened to teachers explain for the fifteenth time how to reduce a fraction. I understand it. "No, Ms. Smith, I didn't show my work. I did it in my head..." Damn kid. Probably copied it. They're all alike. I made a discovery today. I found a computer. Wait a second, this is cool. It does what I want it to. If it makes a mistake, it's because I screwed it up. Not because it doesn't like me... Or feels threatened by me.. Or thinks I'm a smart ass.. Or doesn't like teaching and shouldn't be here... Damn kid. All he does is play games. They're all alike. And then it happened... a door opened to a world... rushing through the phone line like heroin through an addict's veins, an electronic pulse is sent out, a refuge from the day-to-day incompetencies is sought... a board is found. "This is it... this is where I belong..." I know everyone here... even if I've never met them, never talked to them, may never hear from them again... I know you all... Damn kid. Tying up the phone line again. They're all alike... You bet your ass we're all alike... we've been spoon-fed baby food at school when we hungered for steak... the bits of meat that you did let slip through were pre-chewed and tasteless. We've been dominated by sadists, or ignored by the apathetic. The few that had something to teach found us willing pupils, but those few are like drops of water in the desert.

This is our world now... the world of the electron and the switch, the beauty of the baud. We make use of a service already existing without paying for what could be dirt-cheap if it wasn't run by profiteering gluttons, and you call us criminals. We explore... and you call us criminals. We seek after knowledge... and you call us criminals. We exist without skin color, without nationality, without religious bias... and you call us criminals. You build atomic bombs, you wage wars, you murder, cheat, and lie to us and try to make us believe it's for our own good, yet we're the criminals.

Yes, I am a criminal. My crime is that of curiosity. My crime is that of judging people by what they say and think, not what they look like. My crime is that of outsmarting you, something that you will never forgive me for. I am a hacker, and this is my manifesto. You may stop this individual, but you can't stop us all... after all, we're all alike.

+++The Mentor+++

[May the members of the phreak community never forget his words -JR]

-----Exodus----- □

JC-001-026433

have right
black white
wrong white

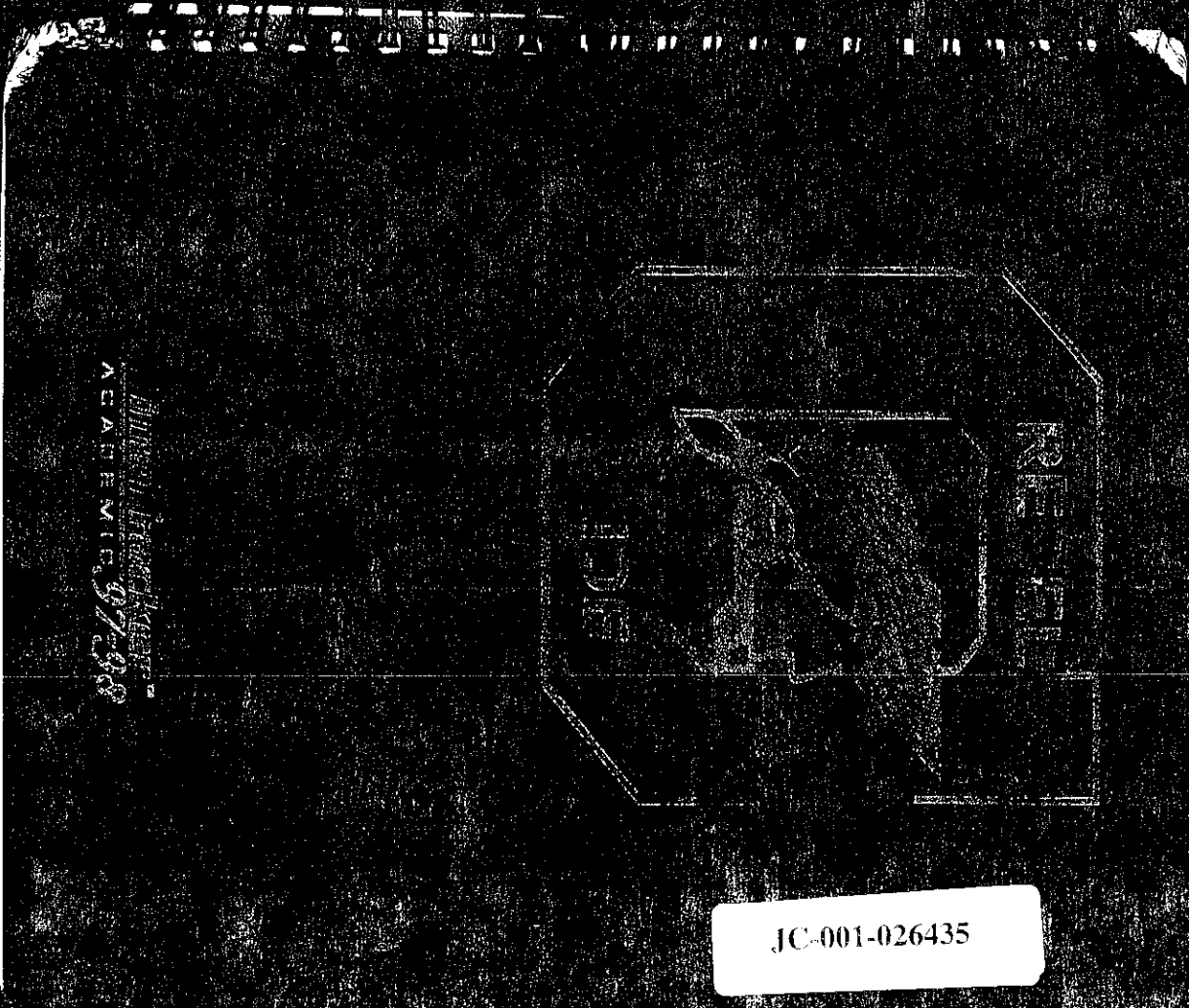

DIESEL-BRAND-KUNST
ACADEMIE
1979

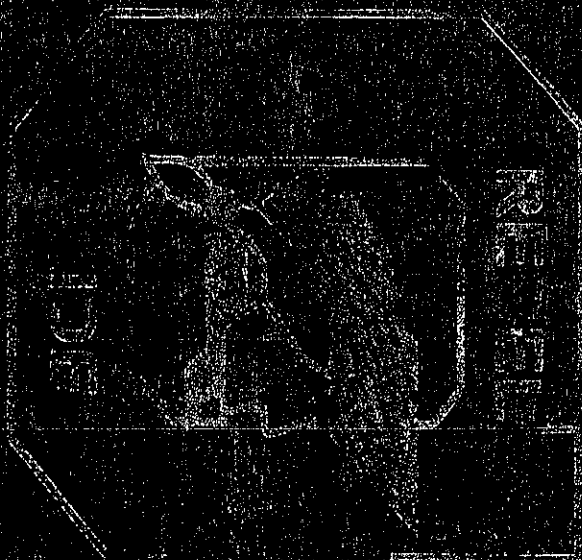

JC-001-026435

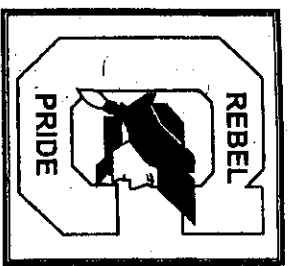

Columbine High School
 ("Stretch for Excellence")

6201 South Pierce Street
 Littleton, Colorado 80123

Attendance - 982-4410
 Bulletin Board - 982-4410
 Counseling - 982-4426
 FAX Number - 982-4401
 Main Office - 982-4400

Sharnick
 Brewster

School Mascot: Rebels
 Colors: Silver and Blue
 School Motto: Stretch for Excellence

COLUMBINE HIGH SCHOOL
 ADMINISTRATIVE STAFF

name	email	phone	fax
Nurain	n1	411	1
Debra	2-	11	0

Principals:
 Frank DeAngelis
Assistant Principals:
 Kevin Lano - Athletic Director
 Karen Studenka - Curriculum and Instruction
 Pat Patrick - Activities Director

hardy as school
 don't give a f---
 if it's good enough
 for you

- At Columbine High School we will Teach, Learn and Model life skills and attitudes that prepare us to:
- Work with People
 - Prepare for Change
 - Think Critically
 - Act Responsibly, and
 - Live in Harmony with Others and with Our Environment

This TimeTracker Belongs to:
 Name SSI Ax for BITCH
 Address In da club chak
 City/State/Zip west side where we live
 Phone # you claim to be a player but I love you wife

we know we had boys agree to school on DATE

3/17 > 2/17

55-#16

1997-1998 DAILY BELL SCHEDULES

REGULAR SCHEDULE

Period 1 7:30-8:20
 Period 2 8:25-9:20
 Period 3 9:25-10:15
 Period 4 10:20-11:10
 Period 5 11:15-11:45
 Lunch A 12:10-12:40
 Lunch B 11:15-12:05
 Class 11:50-12:40
 Class 12:45-1:35
 Period 6 1:40-2:30
 Period 7

**LONG ASSEMBLY SCHEDULE
(65 MINUTES)**

Period 1 7:30-8:10
 Period 2 8:15-9:00
 ASSEMBLY 9:05-10:10
 Period 3 10:15-10:55
 Period 4 11:00-11:40
 Period 5 11:45-12:15
 Lunch A 12:30-1:00
 Lunch B 11:45-12:25
 Class 12:20-1:00
 Class 1:05-1:45
 Period 6 1:50-2:30
 Period 7

THURSDAY SCHEDULE

Period 1 8:10-8:55
 Period 2 9:00-9:45
 Period 3 9:50-10:35
 Period 4 10:40-11:25
 Lunch A 11:30-12:00
 Lunch B 12:05-12:50
 Class 11:30-12:15
 Class 12:55-1:40
 1:45-2:30
 Period 6
 Period 7

**SHORT ASSEMBLY SCHEDULE
(30 MINUTES)**

Period 1 7:30-8:15
 Period 2 8:20-9:10
 ASSEMBLY 9:15-9:45
 Period 3 9:50-10:35
 Period 4 10:40-11:25
 Period 5 11:30-12:00
 Lunch A 12:20-12:50
 Lunch B 11:30-12:15
 Class 12:05-12:50
 Class 12:55-1:40
 1:45-2:30
 Period 6
 Period 7

LUNCH A	LUNCH B
Language Arts	Art
Math	Business
Social Studies	Foreign Language
Tech Arts	Life Management
	Music
	P.E.
	Science

The lovely man strikes with abscond page

1997-1998 IMPORTANT DATES

- AUGUST**
 13..... Senior/Junior Registration
 14..... Sophomore/Freshman Registration
 14..... New Student Orientation
 13-18..... Schedule Change Requests
 18..... Last Day for Schedule Change
 18..... Teachers Report
 20..... Fresh/New Students Pick Up Schedules
 20..... Fresh/New Students Orientation
 20..... 1st Day of Classes, Semester 1
 28..... School Picture Make-Up Day
 28..... Back-To-School Night
 29..... Vision/Floating Screening
- SEPTEMBER**
 1..... Labor Day - NO SCHOOL
 15-20..... Homecoming Week
 19..... Homecoming Game
 20..... Homecoming Dance
- OCTOBER**
 3..... End Six Weeks Grading Period
 8..... Retakes for Students and Faculty
 8..... Report Cards in 2nd hr. Classes
 14-15..... PLAN Test - Sophomores
 14-15..... Parent/Teacher Conferences
 17..... NO SCHOOL
 20-31..... Registration Semester Two
- NOVEMBER**
 14..... End Six Weeks Grading Period
 19..... Report Cards in 2nd hr. Classes
 27-28..... Thanksgiving Holiday - NO SCHOOL
- DECEMBER**
 16..... Receive 2nd Semester Schedules
 17,18,19 - JAN 6..... Schedule Change Requests
 17-18..... Final Exams for Semester 1
 19..... Make-up Day for Semester 1
 19..... End of 1st Semester Grading Period
- JANUARY**
 5..... Teachers Report-Non Student Contact Day
 6..... First Day of Classes, Semester 2
 6..... Schedules in Cafeteria
 6..... Report Cards in Upper Commons
 19..... Martin Luther King Day - NO SCHOOL
 19..... Recognition Breakfast
 26-28.....
- FEBRUARY**
 2-6..... Registration 8th Grade - Ken Caryl
 3..... 8th Grade Parent Meeting
 13..... Columbine Area Inservice - NO SCHOOL
 16..... Presidents Birthday - NO SCHOOL
 20..... End Six Weeks Grading Period
 25..... Report Cards in 2nd hr. classes
 23-Mar 6..... Registration 1998-99 (Gr. 9,10,11)
- MARCH**
 TBA..... Senior Assembly/Class Picture
 12..... Parent/Teacher Conferences
 13..... NO SCHOOL
 16-20..... Spring Break
- APRIL**
 17..... End Six Weeks Grading Period
 18..... Report Cards in 2nd hr. Classes
 22..... Prom
 TBA..... Caps & Gown Distribution
- MAY**
 13-14..... Senior Finals
 15..... Seniors Make-Up Day
 22..... Graduation
 23..... Memorial Day - NO SCHOOL
 27-28.....
 29..... Make-Up Day for Sem. 2
 29..... Last Day of School

TABLE OF CONTENTS

1997-1998 DAILY BELL SCHEDULES 1
 1997-1998 IMPORTANT DATES 2
 ACADEMIC INFORMATION 3
 Counseling 3
 Columbine High School Graduation Requirements 3
 College Admission 4
 Important Testing Dates 4
 Class Drops/Schedule Changes 4
 Withdrawal from School 5
 GENERAL INFORMATION 5
 Lockers 5
 Parking Lot Privileges 5
 Student Parking Policy 5
 Clement Park 5
 Student Identification 5
 Office Information 5
 Financial Office 5
 SERVICES 6
 Columbine High School Library Media Center 6
 School Clinic 6
 Food Services 6
 ATTENDANCE 7
 STUDENT CONDUCT GUIDELINES 7
 Personal Conduct 7
 School Appearance and Property 9
 CLUBS AND ORGANIZATIONS 9
 Art Club 9
 Color Guard (Flag Team) 10
 DECA - Distributive Education Clubs of America 10
 Drama Club/Theatrics 10
 FBI-A-Future Business Leaders of America 10
 FCCIA (Family, Career & Community Leaders of America) 10
 F.ysics 10
 Key Club 10
 National Honor Society 11
 Senate and Student Body Officers 11
 Spirit Squads 11
 Columbine Courier 11
 Relations 11
 Close-Up 12
 Talent Show 12
 PARENT INVOLVEMENT 12
 Band Booster Club 12
 Booster Club 13

Parent-Teacher-Student Association 13
 Columbine Accountability Committee 13
 Post Graduate Volunteers 13
 ATHLETICS 13
 Columbine High School Athletic Program 13
 Training Rule Contract 13
 Academic Eligibility 13
 Varsity and Sub-Varsity Sports 14

ACADEMIC INFORMATION

COUNSELING
 The Columbine Counselors provide a variety of services to students. Each counselor at CHS will participate in personal/social counseling, registration and academic advising, processing of college and scholarship applications, and provide input to students, teachers and parents regarding special needs. Specific services offered by the counselors and each counselor's part of the alphabet are listed below.

RYAN COLLINS (A-C)
 Peer Counseling

JOE CUNNINGHAM (C-O)
 College Counseling
 Coordinator
 NCAA Clearinghouse Liaison

BRAD BUTTS (H-K)
 Department Chairperson
 Alternative School
 Liaison/Litleton (Options)

SUSAN PETERS (L-N)
 Career Counseling/
 Post Grad Center
 Coordinator
 9th Grade/New Student
 Transition Coordinator
 Group Counseling/Support
 Monitor

KEN HOLDEN (O-SM)
 Peer Counseling

COLLEGE COUNSELING
 Coordinator
 NCAA Clearinghouse
 Liaison
 Outdoor Lab

HIGH SCHOOL GRADUATION REQUIREMENTS
 As a student at Columbine High School, you should constantly be aware of the course requirements that are set forth as policies of the Jefferson County Board of Education. With these in mind, it will be easier for you to determine what courses must be taken as you progress toward graduation.

ALL CREDITS EARNED IN GRADES 9 - 12 ARE COLLECTIVELY COUNTED TOWARD HIGH SCHOOL GRADUATION.

Students must complete the following course requirements in grades 9-12:

Requirements for a High School Diploma:

Language Arts 4.0 units/credits
 Social Studies 3.0 units/credits
 Mathematics 2.0 units/credits
 Physical Education 3.0 units/credits
 Science 2.0 units/credits
 Elective Courses 10.5 units/credits
TOTAL UNITS = 22.0

Specific Ninth Grade Requirements:

Language Arts 1.0 unit
 Mathematics 1.0 unit
 Science 1.0 unit
 Social Studies 0.5 unit
 Elective Courses 2.5 units

COLLEGE ADMISSION

Since many of the private schools, as well as some of the state-supported institutions located both in and outside of Colorado, have stringent entrance requirements, it is advisable for you to begin your planning for college admission early in your junior year. Admission representatives from 100 colleges and universities visit Columbine High School each year. They are available to visit with students and parents. The counseling office posts lists of these visiting representatives and when they are scheduled to visit. It is advisable for you to meet with them to get academic and financial aid information about their institutions.

IMPORTANT TESTING DATES:

ACT Testing and Registration Dates

Test Date	Reg. Deadline	Late Reg. Deadline
Oct. 25, 1997	Sept. 22, 1997	Oct. 3, 1997
Nov. 13, 1997	Nov. 10, 1997	Nov. 21, 1997
Feb. 7, 1998	Jan. 5, 1998	Jan. 16, 1998
April 4, 1998	March 2, 1998	March 13, 1998
June 13, 1998	May 11, 1998	May 22, 1998

SAT Testing and Registration Dates

Test Date (SAT I & II)	Reg. Deadline	Late Reg. Deadline
Oct. 4, 1997	Sept. 9, 1997	Sept. 13, 1997
Nov. 1, 1997	Sept. 26, 1997	Oct. 8, 1997
Dec. 6, 1997	Oct. 30, 1997	Nov. 14, 1997
Jan. 24, 1998	Dec. 19, 1997	Dec. 30, 1997
March 28, 1998	Feb. 20, 1998	March 4, 1998
(SAT I only)		
May 2, 1998	March 26, 1998	April 10, 1998
June 6, 1998	April 30, 1998	May 15, 1998

PSAT/NMSQT Testing Dates

October 18, 1997 (Saturday)
 October 14, 1997 (Tuesday - alternate test date for school related conflicts ONLY)
 May 11-27, 1998

Advanced Placement Testing

In-State College Nights

Test Date	Time
Oct. 20, 1997	7:00 p.m.
Arvada West High School	
Oct. 21, 1997	7:00 p.m.
Green Mountain High School	
Oct. 29, 1997	7:00 p.m.
Dakota Ridge High School	

Out-Of-State College Nights

Test Date	Time
Oct. 15, 1997	6:30 p.m.
Wheat Ridge High School	
Oct. 16, 1997	6:30 p.m.
Thomas Jefferson High School	

College Information Metro Workshop

Test Date	Time
Oct. 19, 1997	10 a.m. - 3 p.m.
Cherry Creek High School	

*Boyer's is
 Justin BOOZING*

NOTES:

Lined area for notes.

MARKETODAYCOUNT™

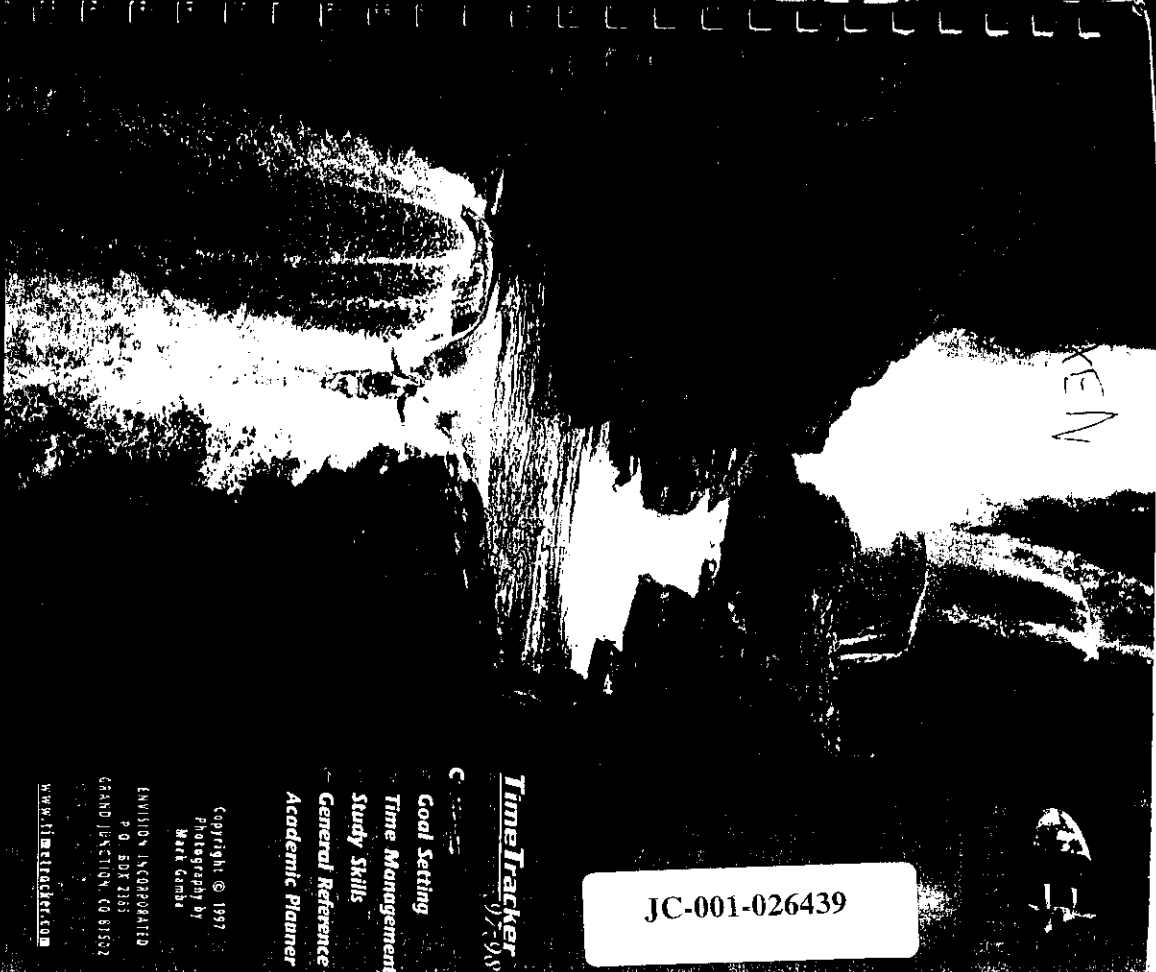

JC-001-026439

TimeTracker
97-98

- Goal Setting
- Time Management
- Study Skills
- General Reference
- Academic Planner

Copyright © 1997
Photograph by
Mark Gamba
ENVISION INCORPORATED
P.O. BOX 2165
GRAND JUNCTION, CO 81502
www.timeTracker.com

AUGUST 11 THRU 24, 1997

JULY

1	2	3	4	5	6	7	8	9	10	11	12	13	14	15	16	17	18	19	20	21	22	23	24	25	26	27	28	29	30	31
---	---	---	---	---	---	---	---	---	----	----	----	----	----	----	----	----	----	----	----	----	----	----	----	----	----	----	----	----	----	----

AUGUST

1	2	3	4	5	6	7	8	9	10	11	12	13	14	15	16	17	18	19	20	21	22	23	24	25	26	27	28	29	30	31
---	---	---	---	---	---	---	---	---	----	----	----	----	----	----	----	----	----	----	----	----	----	----	----	----	----	----	----	----	----	----

SEPTEMBER

1	2	3	4	5	6	7	8	9	10	11	12	13	14	15	16	17	18	19	20	21	22	23	24	25	26	27	28	29	30
---	---	---	---	---	---	---	---	---	----	----	----	----	----	----	----	----	----	----	----	----	----	----	----	----	----	----	----	----	----

WEEKLY PRIORITIES

MONDAY 11	TUESDAY 12	WEDNESDAY 13	THURSDAY 14	FRIDAY 15	SATURDAY 16	SUNDAY 17
Today's Priorities	Today's Priorities	Today's Priorities	Today's Priorities	Today's Priorities	Today's Priorities	Today's Priorities

WEEKLY PRIORITIES

TUESDAY 19	WEDNESDAY 20	THURSDAY 21	FRIDAY 22	SATURDAY 23	SUNDAY 24
Today's Priorities	Today's Priorities	Today's Priorities	Today's Priorities	Today's Priorities	Today's Priorities
			<p>P. 37 - part 12</p> <p>U French</p> <p>read ch. 2 & 3 - SS</p> <p>(egyp & mesp.)</p> <p>CA - exposition</p> <p>psam</p> <p>Joe Fri</p> <p>celebration home</p> <p>John study guide sheet</p>		<p>First Abs!</p>



JC-001-026440

AUGUST 25 THRU 31, 1997

JULY						
1	2	3	4	5	6	7
8	9	10	11	12	13	14
15	16	17	18	19	20	21
22	23	24	25	26	27	28
29	30	31				

AUGUST						
1	2	3	4	5	6	7
8	9	10	11	12	13	14
15	16	17	18	19	20	21
22	23	24	25	26	27	28
29	30	31				

SEPTEMBER						
1	2	3	4	5	6	7
8	9	10	11	12	13	14
15	16	17	18	19	20	21
22	23	24	25	26	27	28
29	30					

WEEKLY PRIORITIES

KMFEDM
BRUTAL

After School Planning	Assignments	Today's Priorities
1	jo math	French worksheet
2	jo math	Math H1 & H3
3	jo math	Govt Book - History
4	jo math	SS meeting & study guide
5	jo math	jo math
6	jo math	jo math
7	jo math	jo math
8	jo math	jo math
9	jo math	jo math

MONDAY 25 TUESDAY 26 WEDNESDAY 27 THURSDAY 28 FRIDAY 29 SATURDAY 30 SUNDAY 31

GOALS·TESTS·PROJECTS



How you choose to use your time will ultimately determine what you will have, and who you become. Look for the Make Today Count symbol throughout your TimeTracker. Each time the symbol appears it will be highlighting a personal trait, attitude, or skill that can help you master your time.

After School Planning	Assignments	Today's Priorities
1	jo math	jo math
2	jo math	jo math
3	jo math	jo math
4	jo math	jo math
5	jo math	jo math
6	jo math	jo math
7	jo math	jo math
8	jo math	jo math
9	jo math	jo math

SEPTEMBER 1 THRU 7, 1997

AUGUST

1	2	3	4	5	6	7
8	9	10	11	12	13	14
15	16	17	18	19	20	21
22	23	24	25	26	27	28
29	30	31				

SEPTEMBER

1	2	3	4	5	6	7
8	9	10	11	12	13	14
15	16	17	18	19	20	21
22	23	24	25	26	27	28
29	30					

OCTOBER

1	2	3	4	5	6	7
8	9	10	11	12	13	14
15	16	17	18	19	20	21
22	23	24	25	26	27	28
29	30	31				

WEEKLY PRIORITIES

After School Planning	Assignments	Today's Priorities
1		
2		
3		
4		
5		
6		
7		
8		
9		

MONDAY 1

TUESDAY 2

WEDNESDAY 3

LABOR DAY

1/2 book
~~Get essay~~
 ready on Grand
 letter card sheet
 math assignment page
 made with phone
 read English sheet
 pages

After School Planning	Assignments	Today's Priorities
1		
2		
3		
4		
5		
6		
7		
8		
9		

THURSDAY 4

FRIDAY 5

SATURDAY 6

SUNDAY 7

2/5 2
 for ranch
 Math sheet

GOALS-TESTS-PROJECTS

September

Prevent a loss of progress plan throughout your time by using this page.
 Discipline yourself to follow your plan and consistently consider your goals.

JC-001-026443

SEPTEMBER 8 THRU 14, 1997

AUGUST						
1	2	3	4	5	6	7
8	9	10	11	12	13	14
15	16	17	18	19	20	21
22	23	24	25	26	27	28
29	30	31				

SEPTEMBER						
1	2	3	4	5	6	7
8	9	10	11	12	13	14
15	16	17	18	19	20	21
22	23	24	25	26	27	28
29	30					

OCTOBER						
1	2	3	4	5	6	7
8	9	10	11	12	13	14
15	16	17	18	19	20	21
22	23	24	25	26	27	28
29	30	31				

WEEKLY PRIORITIES

DEPT

KMFBDN

MONDAY	TUESDAY	WEDNESDAY	THURSDAY
<p>read Ch. 9. 45:49</p> <p>prob 1-3</p> <p>math review sks</p> <p>LA</p>	<p>(support)</p> <p>Finish work</p> <p>read Ch. 17 9:2</p> <p>no math</p> <p>no prevch</p> <p>keep doing ss map</p>	<p>liberal</p> <p>LA</p> <p>LA</p>	<p>LA</p>
1	2	3	4
5	6	7	8
9	10	11	12

GOALS-TESTS-PROJECTS

MONDAY	TUESDAY	WEDNESDAY	THURSDAY
<p>no Acision</p> <p>BITCHIN</p>	<p>work 5:20</p> <p>last DAC</p>		
1	2	3	4
5	6	7	8
9	10	11	12



J-N-T-E-G-R-I-T-Y
 Within your mind the feeling between right and wrong is
 distinct. Be true to yourself and follow your moral path.

OCTOBER 6 THRU 12, 1997

OCTOBER						
1	2	3	4	5	6	7
8	9	10	11	12	13	14
15	16	17	18	19	20	21
22	23	24	25	26	27	28
29	30	31				

OCTOBER						
1	2	3	4	5	6	7
8	9	10	11	12	13	14
15	16	17	18	19	20	21
22	23	24	25	26	27	28
29	30	31				

NOVEMBER						
1	2	3	4	5	6	7
8	9	10	11	12	13	14
15	16	17	18	19	20	21
22	23	24	25	26	27	28
29	30	31				

WEEKLY PRIORITIES

After School Planning	Assignments	Today's Priorities
1		
2		
3		
4		
5		
6		
7		
8		
9		
10		

After School Planning	Assignments	Today's Priorities
1		
2		
3		
4		
5		
6		
7		
8		
9		
10		

GOALS-TESTS-PROJECTS

D·E·T·E·R·M·I·N·A·T·I·O·N
 A challenge ignored eventually becomes a lasting limitation. A challenge confronted is quickly overcome by the desire to achieve.

JC-001-026445

TOBER 13 THRU 19 · 1997

SEPT

1	2	3	4	5	6	7
8	9	10	11	12	13	14
15	16	17	18	19	20	21
22	23	24	25	26	27	28
29	30	31				

OCTOBER

1	2	3	4	5	6	7
8	9	10	11	12	13	14
15	16	17	18	19	20	21
22	23	24	25	26	27	28
29	30	31				

NOVEMBER

1	2	3	4	5	6	7
8	9	10	11	12	13	14
15	16	17	18	19	20	21
22	23	24	25	26	27	28
29	30	31				

WEEKLY PRIORITIES

After School Planning	Assignments	Today's Priorities
1		MONDAY 13 COLUMBUS DAY THANKSGIVING DAY (CANADA)
2		TUESDAY 14
3		WEDNESDAY 15
4		THURSDAY 16
5		FRIDAY 17
6		SATURDAY 18
7		SUNDAY 19
8		
9		

Handwritten notes in the 'Today's Priorities' column:

- Monday 13: French - study Paris, North - ~~the~~ workbook, SS - read & G&T, LA - outline, Chem - study CH13
- Tuesday 14: 1-N, 2 - Homework
- Wednesday 15: 1 - Study work, 2 - nothing, 3 - read a little, 4 - nothing, 5 - nothing, 6 - nothing, 7 - nothing, 8 - nothing, 9 - nothing

GOALS-TESTS-PROJECTS

After School Planning	Assignments	Today's Priorities
1		THURSDAY 16
2		FRIDAY 17
3		SATURDAY 18
4		SUNDAY 19
5		
6		
7		
8		
9		

Handwritten notes in the 'Today's Priorities' column:

- Thursday 16: Study verbs, 223 good
- Friday 17: well holders, organize books, binder papers
- Saturday 18: special checks for books, caps, lens, muds, spikes, toaster, jingle ornaments, mean socks, patch markers, spades



Adventure
Do you get excited about meeting new people, visiting new places, and experiencing new activities? Nurture your spirit of adventure by treating each new day as a unique opportunity to learn more about yourself and the world around you. You only live once, but if you do it right once is enough!

MAKE IT TODAY

NOVEMBER 3 THRU 9, 1997

October

1	2	3	4	5	6	7	8	9	10	11	12	13	14	15	16	17	18	19	20	21	22	23	24	25	26	27	28	29	30	31
---	---	---	---	---	---	---	---	---	----	----	----	----	----	----	----	----	----	----	----	----	----	----	----	----	----	----	----	----	----	----

NOVEMBER

1	2	3	4	5	6	7	8	9	10	11	12	13	14	15	16	17	18	19	20	21	22	23	24	25	26	27	28	29
---	---	---	---	---	---	---	---	---	----	----	----	----	----	----	----	----	----	----	----	----	----	----	----	----	----	----	----	----

DECEMBER

1	2	3	4	5	6	7	8	9	10	11	12	13	14	15	16	17	18	19	20	21	22	23	24	25	26	27	28	29	30	31
---	---	---	---	---	---	---	---	---	----	----	----	----	----	----	----	----	----	----	----	----	----	----	----	----	----	----	----	----	----	----

WEEKLY PRIORITIES

After School Planning	Assignments	Today's Priorities
1		
2		
3		
4		
5		
6		
7		
8		
9		
10		
11		
12		
13		
14		
15		
16		
17		
18		
19		
20		
21		
22		
23		
24		
25		
26		
27		
28		
29		
30		
31		

GOALS-TESTS-PROJECTS

! Anon
! Vodka
p: anon
p: vodka

204.98.1.144

reviews et cetera

After School Planning	Assignments	Today's Priorities
1		
2		
3		
4		
5		
6		
7		
8		
9		
10		
11		
12		
13		
14		
15		
16		
17		
18		
19		
20		
21		
22		
23		
24		
25		
26		
27		
28		
29		
30		
31		

Personal financial goals: save money throughout your time; track to reach your goals. Do your best to do so with your own and community's resources.

JC-001-026447

NOVEMBER 17 THRU 23, 1997

OCTOBER

1	2	3	4	5	6	7	8	9	10	11	12	13	14	15	16	17	18	19	20	21	22	23	24	25	26	27	28	29	30	31
---	---	---	---	---	---	---	---	---	----	----	----	----	----	----	----	----	----	----	----	----	----	----	----	----	----	----	----	----	----	----

NOVEMBER

1	2	3	4	5	6	7	8	9	10	11	12	13	14	15	16	17	18	19	20	21	22	23	24	25	26	27	28	29	30
---	---	---	---	---	---	---	---	---	----	----	----	----	----	----	----	----	----	----	----	----	----	----	----	----	----	----	----	----	----

DECEMBER

1	2	3	4	5	6	7	8	9	10	11	12	13	14	15	16	17	18	19	20	21	22	23	24	25	26	27	28	29	30	31
---	---	---	---	---	---	---	---	---	----	----	----	----	----	----	----	----	----	----	----	----	----	----	----	----	----	----	----	----	----	----

WEEKLY PRIORITIES

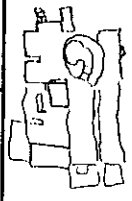

After School Planning	Assignments	Today's Priorities
1		MONDAY 17
2		TUESDAY 18
3		WEDNESDAY 19
4		
5		
6		
7		
8		
9		

GOALS-TESTS-PROJECTS

After School Planning	Assignments	Today's Priorities
1		THURSDAY 20
2		FRIDAY 21
3		SATURDAY 22
4		SUNDAY 23
5		
6		
7		
8		
9		

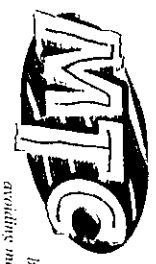

M A K E T O D A Y C O U N T

Initiative

Defeat procrastination by replacing the words in your mind of "Do I have to..." with "I want to because..." Start each day by attacking the single activity you have been avoiding most. Focus on the feeling of exhilaration from knowing that even though your day is only fifteen minutes old you have already accomplished the most unpleasant task facing you all day.

JC-001-026448

NOVEMBER 24 THRU 30 - 1997

October

1	2	3	4	5	6	7	8	9	10	11	12
13	14	15	16	17	18	19	20	21	22	23	24
25	26	27	28	29	30	31					

November

1	2	3	4	5	6	7	8	9	10	11	12
13	14	15	16	17	18	19	20	21	22	23	24
25	26	27	28	29	30						

December

1	2	3	4	5	6	7	8	9	10	11	12
13	14	15	16	17	18	19	20	21	22	23	24
25	26	27	28	29	30	31					

WEEKLY PRIORITIES

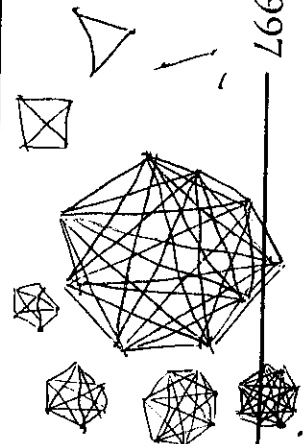

After School Planning	Assignments	Today's Priorities
1 2 3 4 5 6 7 8 9	1 - Study for impasse test 2 - Study for impasse test 3 - Study for impasse test 4 - Study for impasse test 5 - Study for impasse test 6 - Plan credit - tie chosen 7 - Study 8 - Study for impasse test 9 - Study for impasse test	MONDAY 24
1 2 3 4 5 6 7 8 9	1 - Acid = Hydrogen w. negative ion 2 - H ₂ O = Hydrogen Bromide 3 - Hydrogen Sulfide 4 - Hydrogen Sulfide 5 - Hydrogen Sulfide 6 - Hydrogen Sulfide 7 - Hydrogen Sulfide 8 - Hydrogen Sulfide 9 - Hydrogen Sulfide	TUESDAY 25
1 2 3 4 5 6 7 8 9	1 - 35 names 2 - Last highway 3 - Bura	WEDNESDAY 26

After School Planning	Assignments	Today's Priorities
1 2 3 4 5 6 7 8 9	1 - Thank you 2 - Thank you 3 - Thank you 4 - Thank you 5 - Thank you 6 - Thank you 7 - Thank you 8 - Thank you 9 - Thank you	THURSDAY 27 THANKSGIVING DAY
1 2 3 4 5 6 7 8 9	1 - 2 - 3 - 4 - 5 - 6 - 7 - 8 - 9 -	FRIDAY 28
1 2 3 4 5 6 7 8 9	1 - 2 - 3 - 4 - 5 - 6 - 7 - 8 - 9 -	SATURDAY 29
1 2 3 4 5 6 7 8 9	1 - 2 - 3 - 4 - 5 - 6 - 7 - 8 - 9 -	SUNDAY 30

GOALS - TESTS - PROJECTS

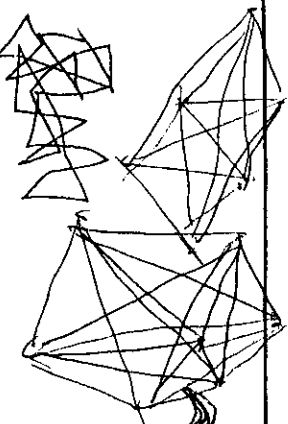

H.A.P.-P-I-N-E-S-S
Happiness is not a goal. Rather, it is a byproduct of taking your dreams seriously and yourself lightly.

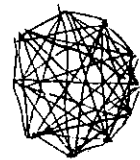

DECEMBER 1995

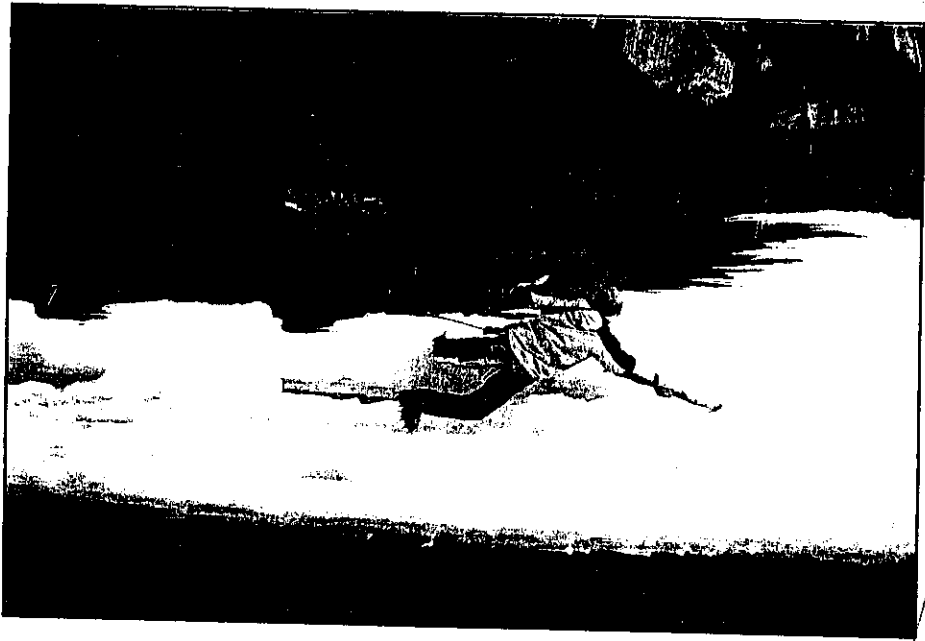

CHALLENGE

There is inherent joy in working to do something that is difficult. Your ability to motivate yourself will elevate you above the plateau of mediocrity.

SUNDAY	MONDAY	TUESDAY	WEDNESDAY	THURSDAY	FRIDAY	SATURDAY	
7	8	9	10	11	12	13	
14	15	16	17	18	19	20	
21 Winter Solstice 1st Day of Winter	22	23	24 Hanukkah Begins	25 Christmas Day	26 Kwanzaa Begins	27	
28	29	30	31	LUNAR CYCLE ● New Moon ● First Quarter ● Full Moon ● Last Quarter			
				NOVEMBER S M T W T F S S 1 2 3 4 5 6 7 8 9 10 11 12 13 14 15 16 17 18 19 20 21 22 23 24 25 26 27 28		JANUARY S M T W T F S S 1 2 3 4 5 6 7 8 9 10 11 12 13 14 15 16 17 18 19 20 21 22 23 24 25 26 27 28	

JC-001-026450

DECEMBER 1 THRU 7, 1997

NOVEMBER

S	M	T	W	T	F	S
1	2	3	4	5	6	7
8	9	10	11	12	13	14
15	16	17	18	19	20	21
22	23	24	25	26	27	28
29	30	31				

DECEMBER

S	M	T	W	T	F	S
1	2	3	4	5	6	7
8	9	10	11	12	13	14
15	16	17	18	19	20	21
22	23	24	25	26	27	28
29	30	31				

JANUARY

S	M	T	W	T	F	S
1	2	3	4	5	6	7
8	9	10	11	12	13	14
15	16	17	18	19	20	21
22	23	24	25	26	27	28
29	30	31				

WEEKLY PRIORITIES

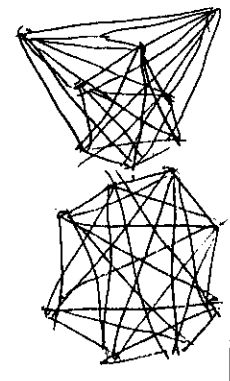

After School Planning	Assignments	Today's Priorities
1 2 3 4 5 6 7 8 9	1) Fix computer 2) Board - 59 p. 553	MONDAY 1
1 2 3 4 5 6 7 8 9	1) Board - 59 p. 553 2) Board - 59 p. 553 3) Board - 59 p. 553 4) Board - 59 p. 553 5) Board - 59 p. 553 6) Board - 59 p. 553 7) Board - 59 p. 553 8) Board - 59 p. 553 9) Board - 59 p. 553	TUESDAY 2
1 2 3 4 5 6 7 8 9	1) Board - 59 p. 553 2) Board - 59 p. 553 3) Board - 59 p. 553 4) Board - 59 p. 553 5) Board - 59 p. 553 6) Board - 59 p. 553 7) Board - 59 p. 553 8) Board - 59 p. 553 9) Board - 59 p. 553	WEDNESDAY 3

After School Planning	Assignments	Today's Priorities
1 2 3 4 5 6 7 8 9	1) Board - 59 p. 553 2) Board - 59 p. 553 3) Board - 59 p. 553 4) Board - 59 p. 553 5) Board - 59 p. 553 6) Board - 59 p. 553 7) Board - 59 p. 553 8) Board - 59 p. 553 9) Board - 59 p. 553	THURSDAY 4
1 2 3 4 5 6 7 8 9	1) Board - 59 p. 553 2) Board - 59 p. 553 3) Board - 59 p. 553 4) Board - 59 p. 553 5) Board - 59 p. 553 6) Board - 59 p. 553 7) Board - 59 p. 553 8) Board - 59 p. 553 9) Board - 59 p. 553	FRIDAY 5
1 2 3 4 5 6 7 8 9	1) Board - 59 p. 553 2) Board - 59 p. 553 3) Board - 59 p. 553 4) Board - 59 p. 553 5) Board - 59 p. 553 6) Board - 59 p. 553 7) Board - 59 p. 553 8) Board - 59 p. 553 9) Board - 59 p. 553	SATURDAY 6
1 2 3 4 5 6 7 8 9	1) Board - 59 p. 553 2) Board - 59 p. 553 3) Board - 59 p. 553 4) Board - 59 p. 553 5) Board - 59 p. 553 6) Board - 59 p. 553 7) Board - 59 p. 553 8) Board - 59 p. 553 9) Board - 59 p. 553	SUNDAY 7

GOALS-TESTS-PROJECTS



Prepared a series of reports... from Friday to now... your goals... your success...

JC-001-026451

DECEMBER 8 THRU 14, 1997

NOVEMBER						
1	2	3	4	5	6	7
8	9	10	11	12	13	14
15	16	17	18	19	20	21
22	23	24	25	26	27	28
29	30	31				

DECEMBER						
1	2	3	4	5	6	7
8	9	10	11	12	13	14
15	16	17	18	19	20	21
22	23	24	25	26	27	28
29	30	31				

JANUARY						
1	2	3	4	5	6	7
8	9	10	11	12	13	14
15	16	17	18	19	20	21
22	23	24	25	26	27	28
29	30	31				

WEEKLY PRIORITIES

After School Planning	Assignments	Today's Priorities
		MONDAY 8
		TUESDAY 9
		WEDNESDAY 10
4		1
5		2
6		3
7		4
8		5
9		6
0		7
		8
		9
		10

GOALS-TESTS-PROJECTS

After School Planning	Assignments	Today's Priorities
		THURSDAY 11
		FRIDAY 12
		SATURDAY 13
		SUNDAY 14
4		1
5		2
6		3
7		4
8		5
9		6
0		7
		8
		9
		10

RNM
 PERS
 EVERANCE
 STEIN

work discipline, and dedication never go unrewarded. This is why it is important to keep yourself moving in the right direction and develop a "never-quit" attitude.

JC-001-026452

JANUARY 5 THRU 11, 1998

DECEMBER

1	2	3	4	5	6	7
8	9	10	11	12	13	14
15	16	17	18	19	20	21
22	23	24	25	26	27	28
29	30	31				

JANUARY

1	2	3	4	5	6	7
8	9	10	11	12	13	14
15	16	17	18	19	20	21
22	23	24	25	26	27	28
29	30	31				

FEBRUARY

1	2	3	4	5	6	7
8	9	10	11	12	13	14
15	16	17	18	19	20	21
22	23	24	25	26	27	28
29	30	31				

WEEKLY PRIORITIES

After School Planning	Assignments	Today's Priorities
1		
2		
3		
4		
5		
6		
7		
8		
9		

~~9:403 Board~~
 ALL homework
 finish
 5:30
 4:30



After School Planning	Assignments	Today's Priorities
1		
2		
3		
4		
5		
6		
7		
8		
9		

1 - Reg of Weeks like story
 from your own experience
 2 - Finish 403 board
 403 board
 2 - ~~Finish 403 board~~
 Finish board
 1 - Song
 Sci-fair lab to make

GOALS-TESTS-PROJECTS

power for those who can find it
 freedom for those who can fight it
 sex for those who can buy it

GOALS
 It is the pursuit of a goal, not the finish
 line, that helps you grow and will change
 your perspective on what is possible.

JC-001-026453

JANUARY 12 THRU 18 · 1998

December

31	30	29	28	27	26	25	24	23	22	21	20	19	18	17	16	15	14	13	12	11	10	9	8	7	6	5	4	3	2	1
----	----	----	----	----	----	----	----	----	----	----	----	----	----	----	----	----	----	----	----	----	----	---	---	---	---	---	---	---	---	---

JANUARY

31	30	29	28	27	26	25	24	23	22	21	20	19	18	17	16	15	14	13	12	11	10	9	8	7	6	5	4	3	2	1
----	----	----	----	----	----	----	----	----	----	----	----	----	----	----	----	----	----	----	----	----	----	---	---	---	---	---	---	---	---	---

FEBRUARY

28	27	26	25	24	23	22	21	20	19	18	17	16	15	14	13	12	11	10	9	8	7	6	5	4	3	2	1
----	----	----	----	----	----	----	----	----	----	----	----	----	----	----	----	----	----	----	---	---	---	---	---	---	---	---	---

WEEKLY PRIORITIES

MONDAY 12	TUESDAY 13	WEDNESDAY 14	THURSDAY 15
<p>Today's Priorities</p> <p>1 - get 3500150 2 - Finish 411 finished - 411 baseof 3 - finish 350 sheet 3 - finish lab 98 4 - Camc/FRed/ get people</p>	<p>59</p>		
1	2	3	4
5	6	7	8
9	10	11	12

FRIDAY 15	SATURDAY 16	SUNDAY 17
<p>Today's Priorities</p> <p>1 - [scribble] 2 - [scribble] - 49 2 - [scribble] 4 - [scribble]</p>	<p>2930 base-66</p>	
1	2	3
4	5	6
7	8	9

GOALS-TESTS-PROJECTS

MAKE TODAY COUNT



Moment . R
 At the beginning of each day review your priorities list and get started! You will be surprised how much you can accomplish if you just dive in and begin working. The sheer momentum of effort will carry you farther than you ever thought possible.

JANUARY 19 THRU 25 · 1998

DECEMBER						
1	2	3	4	5	6	7
8	9	10	11	12	13	14
15	16	17	18	19	20	21
22	23	24	25	26	27	28
29	30	31				

JANUARY						
1	2	3	4	5	6	7
8	9	10	11	12	13	14
15	16	17	18	19	20	21
22	23	24	25	26	27	28
29	30	31				

FEBRUARY						
1	2	3	4	5	6	7
8	9	10	11	12	13	14
15	16	17	18	19	20	21
22	23	24	25	26	27	28
29	30	31				

WEEKLY PRIORITIES

After School Planning	Assignments	Today's Priorities
		MONDAY 19 MARTIN LUTHER KING, JR. DAY
		TUESDAY 20
		WEDNESDAY 21

GOALS-TESTS-PROJECTS

After School Planning	Assignments	Today's Priorities
		THURSDAY 22
		FRIDAY 23
		SATURDAY 24
		SUNDAY 25

G.H.A.R.A.C.T.E.R
It requires true strength of character to enjoy your accomplishments humbly and to accept your disappointments quietly.

JANUARY 26 THRU FEBRUARY 1, 1998

DECEMBER						
S	M	T	W	T	F	S
1	2	3	4	5	6	7
8	9	10	11	12	13	14
15	16	17	18	19	20	21
22	23	24	25	26	27	28
29	30	31				

JANUARY						
S	M	T	W	T	F	S
1	2	3	4	5	6	7
8	9	10	11	12	13	14
15	16	17	18	19	20	21
22	23	24	25	26	27	28
29	30	31				

FEBRUARY						
S	M	T	W	T	F	S
1	2	3	4	5	6	7
8	9	10	11	12	13	14
15	16	17	18	19	20	21
22	23	24	25	26	27	28
29	30	31				

WEEKLY PRIORITIES

The
Downward
Spiral

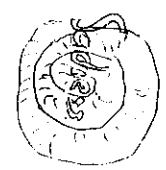

After School Planning	Assignments	Today's Priorities
1	1) Finish handout papers	DLK TO
2	2) Do lab & shift	MIKESSEL
3	3) Read (?)	↓
4	4) 412 1-64 ACC DE	Buying locker
5	5) 110 street 81	moving '85
6	6) 150 street 26	foot &
7	7) 150 street 81	away
8	8) 150 street 81	
9	9) 150 street 81	
10	10) 150 street 81	
11	11) 150 street 81	
12	12) 150 street 81	
13	13) 150 street 81	
14	14) 150 street 81	
15	15) 150 street 81	
16	16) 150 street 81	
17	17) 150 street 81	
18	18) 150 street 81	
19	19) 150 street 81	
20	20) 150 street 81	
21	21) 150 street 81	
22	22) 150 street 81	
23	23) 150 street 81	
24	24) 150 street 81	
25	25) 150 street 81	
26	26) 150 street 81	
27	27) 150 street 81	
28	28) 150 street 81	
29	29) 150 street 81	
30	30) 150 street 81	
31	31) 150 street 81	

GOALS-TESTS-PROJECTS

After School Planning	Assignments	Today's Priorities
1		
2		
3		
4		
5		
6		
7		
8		
9		
10		
11		
12		
13		
14		
15		
16		
17		
18		
19		
20		
21		
22		
23		
24		
25		
26		
27		
28		
29		
30		
31		

The
downward
spiral



SDAY	THURSDAY	FRIDAY	SATURDAY
	5	6	7

131
141
Day

FEBRUARY 19-

JAN
 FEBRUARY 2 THRU 8 · 1998
 MARCH

JANUARY						
1	2	3	4	5	6	7
8	9	10	11	12	13	14
15	16	17	18	19	20	21
22	23	24	25	26	27	28
29	30	31				

FEBRUARY						
1	2	3	4	5	6	7
8	9	10	11	12	13	14
15	16	17	18	19	20	21
22	23	24	25	26	27	28
29	30					

MARCH						
1	2	3	4	5	6	7
8	9	10	11	12	13	14
15	16	17	18	19	20	21
22	23	24	25	26	27	28
29	30	31				

WEEKLY PRIORITIES

451 45
 452 45
 453 45
 454 45
 455 45
 456 45
 457 45
 458 45
 459 45
 460 45
 461 45
 462 45
 463 45
 464 45
 465 45
 466 45
 467 45
 468 45
 469 45
 470 45
 471 45
 472 45
 473 45
 474 45
 475 45
 476 45
 477 45
 478 45
 479 45
 480 45
 481 45
 482 45
 483 45
 484 45
 485 45
 486 45
 487 45
 488 45
 489 45
 490 45
 491 45
 492 45
 493 45
 494 45
 495 45
 496 45
 497 45
 498 45
 499 45
 500 45

After School Planning	Assignments	Today's Priorities
		MONDAY 2 CHANGING DAY North homework mask 16-2, 16-2
1 2 3 4 5 6 7 8 9 10	And I read you And I read you And I read you And I read you And I read you And I read you And I read you And I read you And I read you And I read you	TUESDAY 3 I got my head and my head is unworking... I got my head and my head is unworking... I got my head and my head is unworking... I got my head and my head is unworking... I got my head and my head is unworking... I got my head and my head is unworking... I got my head and my head is unworking... I got my head and my head is unworking... I got my head and my head is unworking... I got my head and my head is unworking...
		WEDNESDAY 4 In all ways, inside, I see the face with all spirit eyes... In all ways, inside, I see the face with all spirit eyes... In all ways, inside, I see the face with all spirit eyes... In all ways, inside, I see the face with all spirit eyes... In all ways, inside, I see the face with all spirit eyes... In all ways, inside, I see the face with all spirit eyes... In all ways, inside, I see the face with all spirit eyes... In all ways, inside, I see the face with all spirit eyes... In all ways, inside, I see the face with all spirit eyes... In all ways, inside, I see the face with all spirit eyes...

After School Planning	Assignments	Today's Priorities
		THURSDAY 5
1 2 3 4 5 6 7 8 9 10	You can have my assignment... You can have my assignment... You can have my assignment... You can have my assignment... You can have my assignment... You can have my assignment... You can have my assignment... You can have my assignment... You can have my assignment... You can have my assignment...	FRIDAY 6 You can have my assignment... You can have my assignment... You can have my assignment... You can have my assignment... You can have my assignment... You can have my assignment... You can have my assignment... You can have my assignment... You can have my assignment... You can have my assignment...
		SATURDAY 7
		SUNDAY 8

GOALS-TESTS-PROJECTS

451 45
 452 45
 453 45
 454 45
 455 45
 456 45
 457 45
 458 45
 459 45
 460 45
 461 45
 462 45
 463 45
 464 45
 465 45
 466 45
 467 45
 468 45
 469 45
 470 45
 471 45
 472 45
 473 45
 474 45
 475 45
 476 45
 477 45
 478 45
 479 45
 480 45
 481 45
 482 45
 483 45
 484 45
 485 45
 486 45
 487 45
 488 45
 489 45
 490 45
 491 45
 492 45
 493 45
 494 45
 495 45
 496 45
 497 45
 498 45
 499 45
 500 45

JC-001-026457

FEBRUARY 9 THRU 15 • 1998

JANUARY						
1	2	3	4	5	6	7
8	9	10	11	12	13	14
15	16	17	18	19	20	21
22	23	24	25	26	27	28
29	30	31				

FEBRUARY						
1	2	3	4	5	6	7
8	9	10	11	12	13	14
15	16	17	18	19	20	21
22	23	24	25	26	27	28
29	30					

MARCH						
1	2	3	4	5	6	7
8	9	10	11	12	13	14
15	16	17	18	19	20	21
22	23	24	25	26	27	28
29	30	31				

WEEKLY PRIORITIES

After School Planning	Assignments	Today's Priorities
1		MONDAY 9
2		① workbooks
3		② study notes and papers
4		③ workbooks
5		④ workbooks
6		⑤ workbooks
7		⑥ workbooks
8		⑦ workbooks
9		⑧ workbooks
		TUESDAY 10
		① workbooks
		② workbooks
		③ workbooks
		④ workbooks
		⑤ workbooks
		⑥ workbooks
		⑦ workbooks
		⑧ workbooks
		⑨ workbooks
		⑩ workbooks
		⑪ workbooks
		⑫ workbooks
		⑬ workbooks
		⑭ workbooks
		⑮ workbooks
		⑯ workbooks
		⑰ workbooks
		⑱ workbooks
		⑲ workbooks
		⑳ workbooks
		㉑ workbooks
		㉒ workbooks
		㉓ workbooks
		㉔ workbooks
		㉕ workbooks
		㉖ workbooks
		㉗ workbooks
		㉘ workbooks
		㉙ workbooks
		㉚ workbooks
		㉛ workbooks
		㉜ workbooks
		㉝ workbooks
		㉞ workbooks
		㉟ workbooks
		㊱ workbooks
		㊲ workbooks
		㊳ workbooks
		㊴ workbooks
		㊵ workbooks
		㊶ workbooks
		㊷ workbooks
		㊸ workbooks
		㊹ workbooks
		㊺ workbooks
		㊻ workbooks
		㊼ workbooks
		㊽ workbooks
		㊾ workbooks
		㊿ workbooks
		MONDAY 9
		TUESDAY 10
		WEDNESDAY 11
		① workbooks
		② workbooks
		③ workbooks
		④ workbooks
		⑤ workbooks
		⑥ workbooks
		⑦ workbooks
		⑧ workbooks
		⑨ workbooks
		⑩ workbooks
		⑪ workbooks
		⑫ workbooks
		⑬ workbooks
		⑭ workbooks
		⑮ workbooks
		⑯ workbooks
		⑰ workbooks
		⑱ workbooks
		⑲ workbooks
		⑳ workbooks
		㉑ workbooks
		㉒ workbooks
		㉓ workbooks
		㉔ workbooks
		㉕ workbooks
		㉖ workbooks
		㉗ workbooks
		㉘ workbooks
		㉙ workbooks
		㉚ workbooks
		㉛ workbooks
		㉜ workbooks
		㉝ workbooks
		㉞ workbooks
		㉟ workbooks
		㊱ workbooks
		㊲ workbooks
		㊳ workbooks
		㊴ workbooks
		㊵ workbooks
		㊶ workbooks
		㊷ workbooks
		㊸ workbooks
		㊹ workbooks
		㊺ workbooks
		㊻ workbooks
		㊼ workbooks
		㊽ workbooks
		㊾ workbooks
		㊿ workbooks

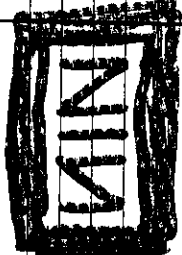

After School Planning	Assignments	Today's Priorities
1		THURSDAY 12
2		FRIDAY 13
3		SATURDAY 14
4		SUNDAY 15
5		
6		
7		
8		
9		

GOALS • TESTS • PROJECTS



CONFIDENCE
The greatest pleasure on earth is doing exactly what you thought you could do, especially when others might have doubted your abilities.

JC-001-026458

FEBRUARY 16 THRU 22 · 1998

JANUARY						
S	M	T	W	T	F	S
			1	2	3	4
5	6	7	8	9	10	11
12	13	14	15	16	17	18
19	20	21	22	23	24	25
26	27	28	29	30	31	

FEBRUARY						
S	M	T	W	T	F	S
			1	2	3	4
5	6	7	8	9	10	11
12	13	14	15	16	17	18
19	20	21	22	23	24	25
26	27	28	29	30	31	

MARCH						
S	M	T	W	T	F	S
			1	2	3	4
5	6	7	8	9	10	11
12	13	14	15	16	17	18
19	20	21	22	23	24	25
26	27	28	29	30	31	

WEEKLY PRIORITIES

Handwritten scribbles and symbols, possibly representing a calendar or notes.

After School Planning	Assignments	Today's Priorities
1 2 3 4 5 6 7 8 9	1 2 3 4 5 6 7 8 9	MONDAY 16 PRESIDENTS DAY Chicagos gromove
1 2 3 4 5 6 7 8 9	1 2 3 4 5 6 7 8 9	TUESDAY 17 Chicagos gromove
1 2 3 4 5 6 7 8 9	1 2 3 4 5 6 7 8 9	WEDNESDAY 18 Chicagos gromove

After School Planning	Assignments	Today's Priorities
1 2 3 4 5 6 7 8 9	1 2 3 4 5 6 7 8 9	THURSDAY 19 Chicagos gromove
1 2 3 4 5 6 7 8 9	1 2 3 4 5 6 7 8 9	FRIDAY 20 Chicagos gromove
1 2 3 4 5 6 7 8 9	1 2 3 4 5 6 7 8 9	SATURDAY 21 Chicagos gromove
1 2 3 4 5 6 7 8 9	1 2 3 4 5 6 7 8 9	SUNDAY 22 Chicagos gromove

GOALS-TESTS-PROJECTS

Large stylized graphic text: "GOALS-TESTS-PROJECTS" and "MAKE IT WORK".

Priorities
 Everything you do each day either moves you closer to accomplishing one of your goals or it doesn't. Reread your written goals in the front of your TimeTracker each morning. This will keep motivation strong and help focus your energies on your priorities.

JC-001-026459

FEBRUARY 23 THRU MARCH 1, 1998

JANUARY

1	2	3	4	5	6	7	8	9	10	11	12
13	14	15	16	17	18	19	20	21	22	23	24
25	26	27	28	29	30	31					



FEBRUARY

1	2	3	4	5	6	7	8	9	10	11	12
13	14	15	16	17	18	19	20	21	22	23	24
25	26	27	28	29	30	31					

MARCH

1	2	3	4	5	6	7	8	9	10	11	12
13	14	15	16	17	18	19	20	21	22	23	24
25	26	27	28	29	30	31					

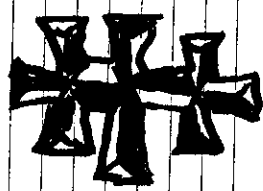
WEEKLY PRIORITIES

After School Planning	Assignments	Today's Priorities
1 2 3 4 5 6 7 8 9 10	<p>① 498 498 499</p> <p>② 499 499 500</p> <p>③ 499 unbrvd - 45-</p> <p>④ 496 boxed</p> <p>⑤ 496 unbrvd</p>	<p>MONDAY 23</p>
1 2 3 4 5 6 7 8 9 10	<p>Due</p> <p></p> <p>Chore</p>	<p>TUESDAY 24</p>
1 2 3 4 5 6 7 8 9 10	<p>AA</p> <p></p>	<p>WEDNESDAY 25</p> <p>ASH WEDNESDAY</p>

After School Planning	Assignments	Today's Priorities
1 2 3 4 5 6 7 8 9 10		<p>THURSDAY 26</p>
1 2 3 4 5 6 7 8 9 10		<p>FRIDAY 27</p>
1 2 3 4 5 6 7 8 9 10		<p>SATURDAY 28</p>
		<p>SUNDAY 1</p>

GOALS-TESTS-PROJECTS

I.N.S.I.G.H.T.
*There are no problems because answers
 abound. Just get rewards those willing
 to look at things from a new perspective.*

JC-001-026460

MARCH 2 THRU 8 • 1998

1	2	3	4	5
6	7	8	9	10
11	12	13	14	15
16	17	18	19	20
21	22	23	24	25
26	27	28	29	30
31				

1	2	3	4	5
6	7	8	9	10
11	12	13	14	15
16	17	18	19	20
21	22	23	24	25
26	27	28	29	30
31				

1	2	3	4	5
6	7	8	9	10
11	12	13	14	15
16	17	18	19	20
21	22	23	24	25
26	27	28	29	30
31				

WEEKLY PRIORITIES

After School Planning	Assignments	Today's Priorities
1		
2		
3		
4		
5		
6		
7		
8		
9		

MONDAY 2

TUESDAY 3

WEDNESDAY 4

North,
 2 - 5:21 work - 4/1
 5/6 work - 4/1

1. X
 2. Vid
 3. 4/1
 4. Calc
 5. Award, CA
 6. Trans Sports
 7. X

1 - Bankrup
 2 - 4/1
 3 - 4/1
 4 - 4/1
 5 - 4/1



GOALS-TESTS-PROJECTS

After School Planning	Assignments	Today's Priorities
1		
2		
3		
4		
5		
6		
7		
8		
9		

THURSDAY 5

FRIDAY 6

SATURDAY 7

Talk

MR
 Bulbs

5/4

SUNDAY 8



Personal, school, work, and home planning and time management. This book is a must for every student, teacher, and parent.

JC-001-026461

MARCH 9 THRU 15, 1998

MARCH						
1	2	3	4	5	6	7
8	9	10	11	12	13	14
15	16	17	18	19	20	21
22	23	24	25	26	27	28
29	30	31				

WEEKLY PRIORITIES

Life is
sweet

After School Planning	Assignments	Today's Priorities
1 2 3 4 5 6 7 8 9		MONDAY 9
1 2 3 4 5 6 7 8 9		TUESDAY 10
1 2 3 4 5 6 7 8 9		WEDNESDAY 11

Handwritten notes in Today's Priorities column:
 Monday 9: PST 8-12, sun
 Tuesday 10: [scribble]
 Wednesday 11: elafit, punk, mix, [scribble]

Handwritten notes in Assignments column:
 Tuesday 10: 5th boxed, vrb word-3, 5th boxed
 Wednesday 11: [scribble]

GOALS-TESTS-PROJECTS

After School Planning	Assignments	Today's Priorities
1 2 3 4 5 6 7 8 9		THURSDAY 12
1 2 3 4 5 6 7 8 9		FRIDAY 13
1 2 3 4 5 6 7 8 9		SATURDAY 14
1 2 3 4 5 6 7 8 9		SUNDAY 15

Handwritten notes in Today's Priorities column:
 Thursday 12: PUNIM
 Saturday 14: [drawing of a crescent moon]



OP-T-I-M-I-S-N
 You will be... determine the outcome. When you expect success, opportunities just seem to come your way.
ATARI TEENAGE RIOT

JC-001-026462

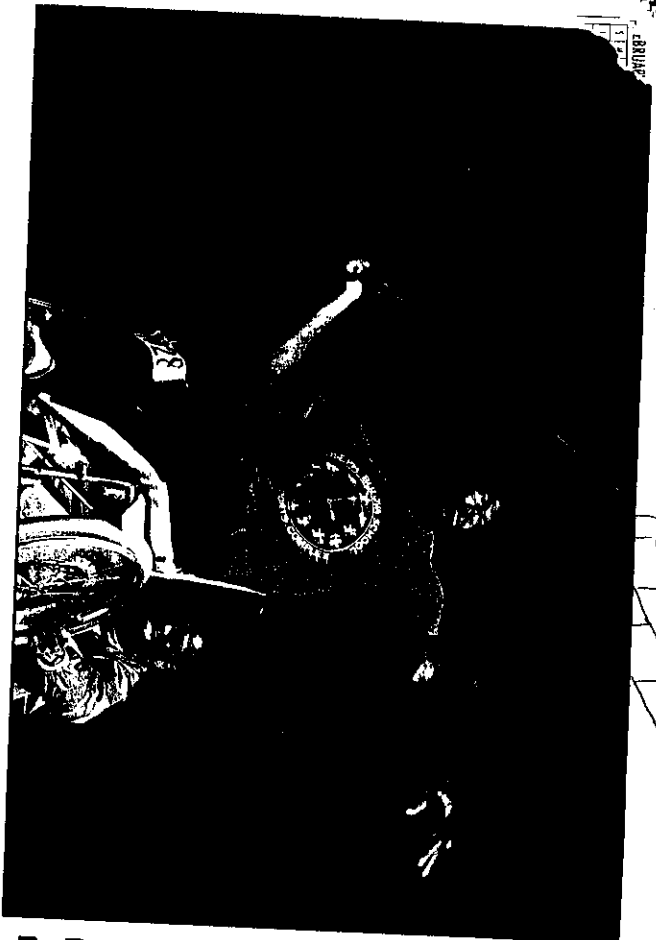

A·T·T·I·T·U·D·E
 All the right attitude, self-imposed limitations vanish.
 For a person's state of mind is always self-given.
For Evet 1/3m

SUNDAY	MONDAY	TUESDAY	WEDNESDAY	THURSDAY	FRIDAY	SATURDAY	SUNDAY
<p>19</p> <p>1 5 2 6 3 0 1 -1 -3 2 0 0 3 -3 6 0 0 8 11 -26</p>	<p>20</p> <p>1 5 2 6 3 0 1 -1 -3 2 0 0 5 -2 -3 2 0 0 3 3 13 6</p>	<p>21</p> <p>1 5 2 6 3 0 1 -1 -3 2 0 0 1 28 44 0 0 3 13 6</p>	<p>22</p> <p>1 5 2 6 3 0 1 -1 -3 2 0 0 1 28 44 0 0 0 -71 -26</p>	<p>23</p> <p>1 5 2 6 3 0 1 -1 -3 2 0 0 1 28 44 0 0 0 155 18 2</p>	<p>24</p> <p>1 5 2 6 3 0 1 -1 -3 2 0 0 1 28 44 0 0 1 28 44</p>	<p>25</p> <p>1 5 2 6 3 0 1 -1 -3 2 0 0 1 28 44 0 0 1 28 44</p>	<p>26</p> <p>1 5 2 6 3 0 1 -1 -3 2 0 0 1 28 44 0 0 1 28 44</p>
<p>27</p> <p>1 5 2 6 3 0 1 -1 -3 2 0 0 1 28 44 0 0 1 28 44</p>	<p>28</p> <p>1 5 2 6 3 0 1 -1 -3 2 0 0 1 28 44 0 0 1 28 44</p>	<p>29</p> <p>1 5 2 6 3 0 1 -1 -3 2 0 0 1 28 44 0 0 1 28 44</p>	<p>30</p> <p>1 5 2 6 3 0 1 -1 -3 2 0 0 1 28 44 0 0 1 28 44</p>	<p>1</p> <p>1 5 2 6 3 0 1 -1 -3 2 0 0 1 28 44 0 0 1 28 44</p>	<p>2</p> <p>1 5 2 6 3 0 1 -1 -3 2 0 0 1 28 44 0 0 1 28 44</p>	<p>3</p> <p>1 5 2 6 3 0 1 -1 -3 2 0 0 1 28 44 0 0 1 28 44</p>	<p>4</p> <p>1 5 2 6 3 0 1 -1 -3 2 0 0 1 28 44 0 0 1 28 44</p>
<p>5</p> <p>1 5 2 6 3 0 1 -1 -3 2 0 0 1 28 44 0 0 1 28 44</p>	<p>6</p> <p>1 5 2 6 3 0 1 -1 -3 2 0 0 1 28 44 0 0 1 28 44</p>	<p>7</p> <p>1 5 2 6 3 0 1 -1 -3 2 0 0 1 28 44 0 0 1 28 44</p>	<p>8</p> <p>1 5 2 6 3 0 1 -1 -3 2 0 0 1 28 44 0 0 1 28 44</p>	<p>9</p> <p>1 5 2 6 3 0 1 -1 -3 2 0 0 1 28 44 0 0 1 28 44</p>	<p>10</p> <p>1 5 2 6 3 0 1 -1 -3 2 0 0 1 28 44 0 0 1 28 44</p>	<p>11</p> <p>1 5 2 6 3 0 1 -1 -3 2 0 0 1 28 44 0 0 1 28 44</p>	<p>12</p> <p>1 5 2 6 3 0 1 -1 -3 2 0 0 1 28 44 0 0 1 28 44</p>
<p>13</p> <p>1 5 2 6 3 0 1 -1 -3 2 0 0 1 28 44 0 0 1 28 44</p>	<p>14</p> <p>1 5 2 6 3 0 1 -1 -3 2 0 0 1 28 44 0 0 1 28 44</p>	<p>15</p> <p>1 5 2 6 3 0 1 -1 -3 2 0 0 1 28 44 0 0 1 28 44</p>	<p>16</p> <p>1 5 2 6 3 0 1 -1 -3 2 0 0 1 28 44 0 0 1 28 44</p>	<p>17</p> <p>1 5 2 6 3 0 1 -1 -3 2 0 0 1 28 44 0 0 1 28 44</p>	<p>18</p> <p>1 5 2 6 3 0 1 -1 -3 2 0 0 1 28 44 0 0 1 28 44</p>	<p>19</p> <p>1 5 2 6 3 0 1 -1 -3 2 0 0 1 28 44 0 0 1 28 44</p>	<p>20</p> <p>1 5 2 6 3 0 1 -1 -3 2 0 0 1 28 44 0 0 1 28 44</p>
<p>21</p> <p>1 5 2 6 3 0 1 -1 -3 2 0 0 1 28 44 0 0 1 28 44</p>	<p>22</p> <p>1 5 2 6 3 0 1 -1 -3 2 0 0 1 28 44 0 0 1 28 44</p>	<p>23</p> <p>1 5 2 6 3 0 1 -1 -3 2 0 0 1 28 44 0 0 1 28 44</p>	<p>24</p> <p>1 5 2 6 3 0 1 -1 -3 2 0 0 1 28 44 0 0 1 28 44</p>	<p>25</p> <p>1 5 2 6 3 0 1 -1 -3 2 0 0 1 28 44 0 0 1 28 44</p>	<p>26</p> <p>1 5 2 6 3 0 1 -1 -3 2 0 0 1 28 44 0 0 1 28 44</p>	<p>27</p> <p>1 5 2 6 3 0 1 -1 -3 2 0 0 1 28 44 0 0 1 28 44</p>	<p>28</p> <p>1 5 2 6 3 0 1 -1 -3 2 0 0 1 28 44 0 0 1 28 44</p>
<p>29</p> <p>1 5 2 6 3 0 1 -1 -3 2 0 0 1 28 44 0 0 1 28 44</p>	<p>30</p> <p>1 5 2 6 3 0 1 -1 -3 2 0 0 1 28 44 0 0 1 28 44</p>	<p>1</p> <p>1 5 2 6 3 0 1 -1 -3 2 0 0 1 28 44 0 0 1 28 44</p>	<p>2</p> <p>1 5 2 6 3 0 1 -1 -3 2 0 0 1 28 44 0 0 1 28 44</p>	<p>3</p> <p>1 5 2 6 3 0 1 -1 -3 2 0 0 1 28 44 0 0 1 28 44</p>	<p>4</p> <p>1 5 2 6 3 0 1 -1 -3 2 0 0 1 28 44 0 0 1 28 44</p>	<p>5</p> <p>1 5 2 6 3 0 1 -1 -3 2 0 0 1 28 44 0 0 1 28 44</p>	<p>6</p> <p>1 5 2 6 3 0 1 -1 -3 2 0 0 1 28 44 0 0 1 28 44</p>
<p>7</p> <p>1 5 2 6 3 0 1 -1 -3 2 0 0 1 28 44 0 0 1 28 44</p>	<p>8</p> <p>1 5 2 6 3 0 1 -1 -3 2 0 0 1 28 44 0 0 1 28 44</p>	<p>9</p> <p>1 5 2 6 3 0 1 -1 -3 2 0 0 1 28 44 0 0 1 28 44</p>	<p>10</p> <p>1 5 2 6 3 0 1 -1 -3 2 0 0 1 28 44 0 0 1 28 44</p>	<p>11</p> <p>1 5 2 6 3 0 1 -1 -3 2 0 0 1 28 44 0 0 1 28 44</p>	<p>12</p> <p>1 5 2 6 3 0 1 -1 -3 2 0 0 1 28 44 0 0 1 28 44</p>	<p>13</p> <p>1 5 2 6 3 0 1 -1 -3 2 0 0 1 28 44 0 0 1 28 44</p>	<p>14</p> <p>1 5 2 6 3 0 1 -1 -3 2 0 0 1 28 44 0 0 1 28 44</p>
<p>15</p> <p>1 5 2 6 3 0 1 -1 -3 2 0 0 1 28 44 0 0 1 28 44</p>	<p>16</p> <p>1 5 2 6 3 0 1 -1 -3 2 0 0 1 28 44 0 0 1 28 44</p>	<p>17</p> <p>1 5 2 6 3 0 1 -1 -3 2 0 0 1 28 44 0 0 1 28 44</p>	<p>18</p> <p>1 5 2 6 3 0 1 -1 -3 2 0 0 1 28 44 0 0 1 28 44</p>	<p>19</p> <p>1 5 2 6 3 0 1 -1 -3 2 0 0 1 28 44 0 0 1 28 44</p>	<p>20</p> <p>1 5 2 6 3 0 1 -1 -3 2 0 0 1 28 44 0 0 1 28 44</p>	<p>21</p> <p>1 5 2 6 3 0 1 -1 -3 2 0 0 1 28 44 0 0 1 28 44</p>	<p>22</p> <p>1 5 2 6 3 0 1 -1 -3 2 0 0 1 28 44 0 0 1 28 44</p>
<p>23</p> <p>1 5 2 6 3 0 1 -1 -3 2 0 0 1 28 44 0 0 1 28 44</p>	<p>24</p> <p>1 5 2 6 3 0 1 -1 -3 2 0 0 1 28 44 0 0 1 28 44</p>	<p>25</p> <p>1 5 2 6 3 0 1 -1 -3 2 0 0 1 28 44 0 0 1 28 44</p>	<p>26</p> <p>1 5 2 6 3 0 1 -1 -3 2 0 0 1 28 44 0 0 1 28 44</p>	<p>27</p> <p>1 5 2 6 3 0 1 -1 -3 2 0 0 1 28 44 0 0 1 28 44</p>	<p>28</p> <p>1 5 2 6 3 0 1 -1 -3 2 0 0 1 28 44 0 0 1 28 44</p>	<p>29</p> <p>1 5 2 6 3 0 1 -1 -3 2 0 0 1 28 44 0 0 1 28 44</p>	<p>30</p> <p>1 5 2 6 3 0 1 -1 -3 2 0 0 1 28 44 0 0 1 28 44</p>

ARCH 30 THRU APRIL 5, 1998

MARCH

1	2	3	4	5	6	7	8	9	10	11	12	13	14	15	16	17	18	19	20	21	22	23	24	25	26	27	28	29	30	31
---	---	---	---	---	---	---	---	---	----	----	----	----	----	----	----	----	----	----	----	----	----	----	----	----	----	----	----	----	----	----

APRIL

1	2	3	4	5	6	7	8	9	10	11	12	13	14	15	16	17	18	19	20	21	22	23	24	25	26	27	28	29	30
---	---	---	---	---	---	---	---	---	----	----	----	----	----	----	----	----	----	----	----	----	----	----	----	----	----	----	----	----	----

MAY

1	2	3	4	5	6	7	8	9	10	11	12	13	14	15	16	17	18	19	20	21	22	23	24	25	26	27	28	29	30	31
---	---	---	---	---	---	---	---	---	----	----	----	----	----	----	----	----	----	----	----	----	----	----	----	----	----	----	----	----	----	----

WEEKLY PRIORITIES

MONDAY 30	TUESDAY 31	WEDNESDAY	THURSDAY
<p>Today's Priorities</p> <p>1 354 - exc. 8 2 546 Bowed</p>	<p>Today's Priorities</p> <p>1 354 exc. 9 2 47 29-47 worked</p> <p>3 546 Bowed</p>		
1	1	1	1
2	2	2	2
3	3	3	3
4	4	4	4
5	5	5	5
6	6	6	6
7	7	7	7
8	8	8	8
9	9	9	9

GOALS-TESTS-PROJECTS

TUESDAY 31	WEDNESDAY	THURSDAY
<p>Today's Priorities</p> <p>3 3 12 6 1 1 4 2 2 5 20 10 - 1 2 8 4</p>	<p>Today's Priorities</p> <p>1 1 4 2 / 1 1 4 2 2 5 20 10 / 0 3 12 6 - 1 2 8 4 / 1 1 4 2</p> <p>$x + y = 2$ $x - y = 2$ $x = 2, y = 0$ $x = 2, y = 2$ $x = 2, y = 4$ $x = 2, y = 6$ $x = 2, y = 8$</p>	<p>TURN IN ENROLLMENT</p>
1	1	1
2	2	2
3	3	3
4	4	4
5	5	5
6	6	6
7	7	7
8	8	8
9	9	9



O.N.
omitting from
of these
ACCESS.

PAID SUNDAY
DAYLIGHT SAVINGS BEGINS
2:00 AM

JC-001-026465

ARCH THRU 12 · 1998

MARCH

1	2	3	4	5	6	7
8	9	10	11	12	13	14
15	16	17	18	19	20	21
22	23	24	25	26	27	28
29	30	31				

APRIL

1	2	3	4	5	6	7
8	9	10	11	12	13	14
15	16	17	18	19	20	21
22	23	24	25	26	27	28
29	30					

MAY

1	2	3	4	5	6	7
8	9	10	11	12	13	14
15	16	17	18	19	20	21
22	23	24	25	26	27	28
29	30	31				

WEEKLY PRIORITIES

[Handwritten scribbles and lines]

After School Planning	Assignments	Today's Priorities
1		
2		
3		
4		
5		
6		
7		
8		
9		

[Handwritten notes in Assignments column: 5/15-36, Devils - 599 odds - 47, 5/18 21-38]

After School Planning	Assignments	Today's Priorities
1		
2		
3		
4		
5		
6		
7		
8		
9		

[Handwritten notes: GOOD FRIDAY, PASCHER]

GOALS·TESTS·PROJECTS

[Large handwritten scribble]

E·N·V·I·S·I·O·N
 Each day envision your dreams, combine time
 Through continued visualization of these
 positive images, you set yourself up for success.

JC-001-026466

APRIL 13 THRU 19, 1998

MARCH						
1	2	3	4	5	6	7
8	9	10	11	12	13	14
15	16	17	18	19	20	21
22	23	24	25	26	27	28
29	30	31				

APRIL						
1	2	3	4	5	6	7
8	9	10	11	12	13	14
15	16	17	18	19	20	21
22	23	24	25	26	27	28
29	30					

MAY						
1	2	3	4	5	6	7
8	9	10	11	12	13	14
15	16	17	18	19	20	21
22	23	24	25	26	27	28
29	30	31				

WEEKLY PRIORITIES

MONDAY 13

Today's Priorities

Assignments

After School Planning

Review of 4/5/97
with 1/2/98
PPT 12-29

3 SSD 1-5
2 boxes - 59 box

Beautiful
as the sky
shout

1
2
3
4
5
6
7
8
9

MONDAY 16

Today's Priorities

Assignments

GOALS-TESTS-PROJECTS

16/10
22/22
43/43

2-6-13
6-13
6-13

SENDING
SENDING

1
2
3
4
5
6
7
8
9

MTC

MAK E T O D A Y C O U N T

Exerc.

The physical and mental benefits of exercise are ~~obvious~~ - every day ~~exercise~~ is always better than nothing and ~~regular exercise~~ is one of your top priorities by writing out your ~~exercise~~ agenda ahead of time and then scheduling the ~~exercise~~ into your day.

JC-001-026467

APRIL 20 THRU 26 · 1998

MARCH

1	2	3	4	5	6	7	8	9	10	11	12
13	14	15	16	17	18	19	20	21	22	23	24
25	26	27	28	29	30	31					

APRIL

1	2	3	4	5	6	7	8	9	10	11	12
13	14	15	16	17	18	19	20	21	22	23	24
25	26	27	28	29	30	31					

MAY

1	2	3	4	5	6	7	8	9	10	11	12
13	14	15	16	17	18	19	20	21	22	23	24
25	26	27	28	29	30	31					

WEEKLY PRIORITIES

~~Handwritten scribbles and notes in the weekly priorities section.~~

After School Planning	Assignments	Today's Priorities
1	3 Finish Lab	MONDAY 20
2	556, p. 14-20	
3	678	TUESDAY 21
4	678 board work	
5		WEDNESDAY 22
6		
7		THURSDAY 23
8		
9		FRIDAY 24
10		

After School Planning	Assignments	Today's Priorities
1	1 p. 364 - ex. 4 & 5	TUESDAY 23
2	173 Board work	
3	674 board work	FRIDAY 24
4	556 board	
5		SATURDAY 25
6		
7		SUNDAY 26
8		
9		MONDAY 27
10		

GOALS-TESTS-PROJECTS

Handwritten notes and diagrams in the goals section, including a drawing of a square with a circle inside and the word "LOYALTY" written vertically.

JC-001-026468

APRIL 27 THRU MAY 3 · 1998

MARCH						
1	2	3	4	5	6	7
8	9	10	11	12	13	14
15	16	17	18	19	20	21
22	23	24	25	26	27	28
29	30	31				

APRIL						
1	2	3	4	5	6	7
8	9	10	11	12	13	14
15	16	17	18	19	20	21
22	23	24	25	26	27	28
29	30	31				

MAY						
1	2	3	4	5	6	7
8	9	10	11	12	13	14
15	16	17	18	19	20	21
22	23	24	25	26	27	28
29	30	31				

WEEKLY PRIORITIES

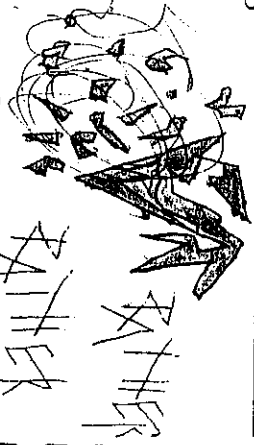

Monday 27	Tuesday 28	Wednesday 29
<p>Today's Priorities</p> <ul style="list-style-type: none"> 1 Ch 20 print 2 6th hour 3 7th hour 4 8th hour 5 9th hour 6 10th hour 7 11th hour 8 12th hour <p>After School Planning</p> <ul style="list-style-type: none"> 1 City notebook - S1 2 City notebook - S1 3 City notebook - S1 4 City notebook - S1 5 City notebook - S1 6 City notebook - S1 7 City notebook - S1 8 City notebook - S1 9 City notebook - S1 10 City notebook - S1 11 City notebook - S1 12 City notebook - S1 	<p>can't think</p> <p>nisgar behind</p> <p>take me home</p>	<p>white's</p> <p>green</p>

GOALS-TESTS-PROJECTS

Monday 27	Tuesday 28	Wednesday 29
<p>Today's Priorities</p> <ul style="list-style-type: none"> 1 20 2 21 3 22 4 23 5 24 6 25 7 26 8 27 9 28 10 29 11 30 12 31 	<p>Division</p> <p>3:30</p>	<p>RAMMSTEIN</p>

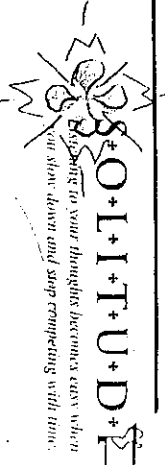

JC-001-026469

APR 4 THRU 10, 1998

MON	TUE	WED	THU	FRI	SAT	SUN
1	2	3	4	5	6	7
8	9	10	11	12	13	14
15	16	17	18	19	20	21
22	23	24	25	26	27	28
29	30	31				

MON	TUE	WED	THU	FRI	SAT	SUN
1	2	3	4	5	6	7
8	9	10	11	12	13	14
15	16	17	18	19	20	21
22	23	24	25	26	27	28
29	30	31				

MON	TUE	WED	THU	FRI	SAT	SUN
1	2	3	4	5	6	7
8	9	10	11	12	13	14
15	16	17	18	19	20	21
22	23	24	25	26	27	28
29	30	31				

WEEKLY PRIORITIES



Shirley
C. ...

After School Planning	Assignments	Today's Priorities
MONDAY 4	TUESDAY 5	WEDNESDAY 6
<p>Handwritten notes and scribbles.</p>	<p>CINCO DE MAYO GARNISH</p> <p>Handwritten notes and scribbles.</p>	<p>674 board - 39</p> <p>665 board - 39</p> <p>Handwritten notes and scribbles.</p>

After School Planning	Today's Priorities
THURSDAY 7	FRIDAY 8
<p>Handwritten notes and scribbles.</p>	<p>Handwritten notes and scribbles.</p>
SUNDAY 10	

GOALS-TESTS-PROJECTS

Realizing your beautiful, as beautiful as the sun, wonderful your beautiful, as wonderful as they come, & your beginning to feel grateful to the feelings I can't describe.

with my true presence & the glasses

Remember to me

Beautiful you beautiful as wonderful as they are - wonderful, it's wonderful, to know that you just like I ... & for you you know me well.

JC-001-026470

MAY 11 THRU 17, 1998

APRIL						
1	2	3	4	5	6	7
8	9	10	11	12	13	14
15	16	17	18	19	20	21
22	23	24	25	26	27	28
29	30	31				

MAY						
1	2	3	4	5	6	7
8	9	10	11	12	13	14
15	16	17	18	19	20	21
22	23	24	25	26	27	28
29	30	31				

JUNE						
1	2	3	4	5	6	7
8	9	10	11	12	13	14
15	16	17	18	19	20	21
22	23	24	25	26	27	28
29	30	31				

WEEKLY PRIORITIES

After School Planning	Assignments	Today's Priorities
1	① Paper clips Miss-605 'ave 3	<p>MONDAY 11</p> <p>TUESDAY 12</p> <p>WEDNESDAY 13</p>
2	② 713 odds-30	
3	③ 727 odds-39	
4	④ 522 odds-15	
5	⑤ 713 odds-30	
6	⑥ 727 odds-39	
7	⑦ 522 odds-15	
8	⑧ 713 odds-30	
9	⑨ 727 odds-39	
10	⑩ 522 odds-15	
<p>QUESTION SHEET</p>		

After School Planning	Assignments	Today's Priorities
1		<p>THURSDAY 14</p> <p>FRIDAY 15</p> <p>SATURDAY 16</p> <p>SUNDAY 17</p>
2		
3		
4		
5		
6		
7		
8		
9		
10		
<p>ARMED FORCES DAY</p>		

GOALS-TESTS-PROJECTS

D.E.S.I.R.E
*What personal desire is strong enough,
 limitations vanish, and human potential abounds.*

JC-001-026471

MAY 25 THRU 31 · 1998

APRIL

1	2	3	4	5	6	7	8	9	10
11	12	13	14	15	16	17	18	19	20
21	22	23	24	25	26	27	28	29	30
31									

MAY

1	2	3	4	5	6	7	8	9	10
11	12	13	14	15	16	17	18	19	20
21	22	23	24	25	26	27	28	29	30
31									

JUNE

1	2	3	4	5	6	7	8	9	10
11	12	13	14	15	16	17	18	19	20
21	22	23	24	25	26	27	28	29	30
31									

WEEKLY PRIORITIES

After School Planning	Assignments	Today's Priorities
1 2 3 4 5 6 7 8 9		MONDAY 25 MEMORIAL DAY
1 2 3 4 5 6 7 8 9		TUESDAY 26
1 2 3 4 5 6 7 8 9		WEDNESDAY 27

After School Planning	Assignments	Today's Priorities
1 2 3 4 5 6 7 8 9		THURSDAY 28
1 2 3 4 5 6 7 8 9		FRIDAY 29
1 2 3 4 5 6 7 8 9		SATURDAY 30
1 2 3 4 5 6 7 8 9		SUNDAY 31

GOALS · TESTS · PROJECTS

U·N·D·E·R·S·T·A·N·D·I·N·G
To understand each other's differences we must learn to listen with an open mind.

JC-001-026472

AUGUST 1998

SUNDAY	MONDAY	TUESDAY	WEDNESDAY	THURSDAY	FRIDAY	SATURDAY
1	2	3	4	5	6	7
8	9	10	11	12	13	14
15	16	17	18	19	20	21
22	23	24	25	26	27	28
29	30					

July

S	M	T	W	T	F	S
1	2	3	4	5	6	7
8	9	10	11	12	13	14
15	16	17	18	19	20	21
22	23	24	25	26	27	28
29	30	31				

September

S	M	T	W	T	F	S
1	2	3	4	5	6	7
8	9	10	11	12	13	14
15	16	17	18	19	20	21
22	23	24	25	26	27	28
29	30	1	2	3	4	5

- LUNAR CYCLE
- New Moon
 - First Quarter
 - Full Moon
 - Last Quarter

WEEKLY PRIORITIES

So mamon so
dun, she can't
spell misspell
correctly



AUGUST 3 THRU 9 • 1998

MONDAY 3	TUESDAY 4	WEDNESDAY 5
Today's Priorities	Today's Priorities	Today's Priorities
THURSDAY 6	FRIDAY 7	SATURDAY 8
Today's Priorities	Today's Priorities	Today's Priorities
SUNDAY 9		
Today's Priorities		

JC-001-026473

What you choose to do with your time each day will ultimately determine what you do, what you have, and who you become. Envivision, Inc. is committed to developing products that help people make today count by gaining control of their most valuable asset—TIME.

TimeTrackers — \$10⁰⁰

- Academic (Aug-Aug)
- 1100E - Elementary School (8.5% 11")
- 1100M - Middle School (8.5% 11")
- 1100H - High School (7" x 8.5")
- 1100T - Teacher (7" x 8.5")
- 1100C - Collegiate (7" x 8.5")
- Yearly TimeTracker (Jan-Dec)
- 1000Y - Yearly (7" x 8.5")

We also carry a wide range of binders and accessories to accommodate your TimeTracker.

For more information or to order call
800.622.2385

MARKET TODAY ACCOUNT

ENVIVISION INCORPORATED
P.O. BOX 2385
GRAND JUNCTION, CO 81502
800.622.2385
FAX 970.243.3004
<http://www.timekeeper.com>

1997		1998		1999																																																																																																																																																																																																																																																													
July	January	July	January	July	January																																																																																																																																																																																																																																																												
<table border="1"> <tr><td>S</td><td>M</td><td>T</td><td>W</td><td>T</td><td>F</td><td>S</td></tr> <tr><td>1</td><td>2</td><td>3</td><td>4</td><td>5</td><td>6</td><td>7</td></tr> <tr><td>8</td><td>9</td><td>10</td><td>11</td><td>12</td><td>13</td><td>14</td></tr> <tr><td>15</td><td>16</td><td>17</td><td>18</td><td>19</td><td>20</td><td>21</td></tr> <tr><td>22</td><td>23</td><td>24</td><td>25</td><td>26</td><td>27</td><td>28</td></tr> <tr><td>29</td><td>30</td><td>31</td><td></td><td></td><td></td><td></td></tr> </table>	S	M	T	W	T	F	S	1	2	3	4	5	6	7	8	9	10	11	12	13	14	15	16	17	18	19	20	21	22	23	24	25	26	27	28	29	30	31					<table border="1"> <tr><td>S</td><td>M</td><td>T</td><td>W</td><td>T</td><td>F</td><td>S</td></tr> <tr><td>1</td><td>2</td><td>3</td><td>4</td><td>5</td><td>6</td><td>7</td></tr> <tr><td>8</td><td>9</td><td>10</td><td>11</td><td>12</td><td>13</td><td>14</td></tr> <tr><td>15</td><td>16</td><td>17</td><td>18</td><td>19</td><td>20</td><td>21</td></tr> <tr><td>22</td><td>23</td><td>24</td><td>25</td><td>26</td><td>27</td><td>28</td></tr> <tr><td>29</td><td>30</td><td>31</td><td></td><td></td><td></td><td></td></tr> </table>	S	M	T	W	T	F	S	1	2	3	4	5	6	7	8	9	10	11	12	13	14	15	16	17	18	19	20	21	22	23	24	25	26	27	28	29	30	31					<table border="1"> <tr><td>S</td><td>M</td><td>T</td><td>W</td><td>T</td><td>F</td><td>S</td></tr> <tr><td>1</td><td>2</td><td>3</td><td>4</td><td>5</td><td>6</td><td>7</td></tr> <tr><td>8</td><td>9</td><td>10</td><td>11</td><td>12</td><td>13</td><td>14</td></tr> <tr><td>15</td><td>16</td><td>17</td><td>18</td><td>19</td><td>20</td><td>21</td></tr> <tr><td>22</td><td>23</td><td>24</td><td>25</td><td>26</td><td>27</td><td>28</td></tr> <tr><td>29</td><td>30</td><td>31</td><td></td><td></td><td></td><td></td></tr> </table>	S	M	T	W	T	F	S	1	2	3	4	5	6	7	8	9	10	11	12	13	14	15	16	17	18	19	20	21	22	23	24	25	26	27	28	29	30	31					<table border="1"> <tr><td>S</td><td>M</td><td>T</td><td>W</td><td>T</td><td>F</td><td>S</td></tr> <tr><td>1</td><td>2</td><td>3</td><td>4</td><td>5</td><td>6</td><td>7</td></tr> <tr><td>8</td><td>9</td><td>10</td><td>11</td><td>12</td><td>13</td><td>14</td></tr> <tr><td>15</td><td>16</td><td>17</td><td>18</td><td>19</td><td>20</td><td>21</td></tr> <tr><td>22</td><td>23</td><td>24</td><td>25</td><td>26</td><td>27</td><td>28</td></tr> <tr><td>29</td><td>30</td><td>31</td><td></td><td></td><td></td><td></td></tr> </table>	S	M	T	W	T	F	S	1	2	3	4	5	6	7	8	9	10	11	12	13	14	15	16	17	18	19	20	21	22	23	24	25	26	27	28	29	30	31					<table border="1"> <tr><td>S</td><td>M</td><td>T</td><td>W</td><td>T</td><td>F</td><td>S</td></tr> <tr><td>1</td><td>2</td><td>3</td><td>4</td><td>5</td><td>6</td><td>7</td></tr> <tr><td>8</td><td>9</td><td>10</td><td>11</td><td>12</td><td>13</td><td>14</td></tr> <tr><td>15</td><td>16</td><td>17</td><td>18</td><td>19</td><td>20</td><td>21</td></tr> <tr><td>22</td><td>23</td><td>24</td><td>25</td><td>26</td><td>27</td><td>28</td></tr> <tr><td>29</td><td>30</td><td>31</td><td></td><td></td><td></td><td></td></tr> </table>	S	M	T	W	T	F	S	1	2	3	4	5	6	7	8	9	10	11	12	13	14	15	16	17	18	19	20	21	22	23	24	25	26	27	28	29	30	31					<table border="1"> <tr><td>S</td><td>M</td><td>T</td><td>W</td><td>T</td><td>F</td><td>S</td></tr> <tr><td>1</td><td>2</td><td>3</td><td>4</td><td>5</td><td>6</td><td>7</td></tr> <tr><td>8</td><td>9</td><td>10</td><td>11</td><td>12</td><td>13</td><td>14</td></tr> <tr><td>15</td><td>16</td><td>17</td><td>18</td><td>19</td><td>20</td><td>21</td></tr> <tr><td>22</td><td>23</td><td>24</td><td>25</td><td>26</td><td>27</td><td>28</td></tr> <tr><td>29</td><td>30</td><td>31</td><td></td><td></td><td></td><td></td></tr> </table>	S	M	T	W	T	F	S	1	2	3	4	5	6	7	8	9	10	11	12	13	14	15	16	17	18	19	20	21	22	23	24	25	26	27	28	29	30	31				
S	M	T	W	T	F	S																																																																																																																																																																																																																																																											
1	2	3	4	5	6	7																																																																																																																																																																																																																																																											
8	9	10	11	12	13	14																																																																																																																																																																																																																																																											
15	16	17	18	19	20	21																																																																																																																																																																																																																																																											
22	23	24	25	26	27	28																																																																																																																																																																																																																																																											
29	30	31																																																																																																																																																																																																																																																															
S	M	T	W	T	F	S																																																																																																																																																																																																																																																											
1	2	3	4	5	6	7																																																																																																																																																																																																																																																											
8	9	10	11	12	13	14																																																																																																																																																																																																																																																											
15	16	17	18	19	20	21																																																																																																																																																																																																																																																											
22	23	24	25	26	27	28																																																																																																																																																																																																																																																											
29	30	31																																																																																																																																																																																																																																																															
S	M	T	W	T	F	S																																																																																																																																																																																																																																																											
1	2	3	4	5	6	7																																																																																																																																																																																																																																																											
8	9	10	11	12	13	14																																																																																																																																																																																																																																																											
15	16	17	18	19	20	21																																																																																																																																																																																																																																																											
22	23	24	25	26	27	28																																																																																																																																																																																																																																																											
29	30	31																																																																																																																																																																																																																																																															
S	M	T	W	T	F	S																																																																																																																																																																																																																																																											
1	2	3	4	5	6	7																																																																																																																																																																																																																																																											
8	9	10	11	12	13	14																																																																																																																																																																																																																																																											
15	16	17	18	19	20	21																																																																																																																																																																																																																																																											
22	23	24	25	26	27	28																																																																																																																																																																																																																																																											
29	30	31																																																																																																																																																																																																																																																															
S	M	T	W	T	F	S																																																																																																																																																																																																																																																											
1	2	3	4	5	6	7																																																																																																																																																																																																																																																											
8	9	10	11	12	13	14																																																																																																																																																																																																																																																											
15	16	17	18	19	20	21																																																																																																																																																																																																																																																											
22	23	24	25	26	27	28																																																																																																																																																																																																																																																											
29	30	31																																																																																																																																																																																																																																																															
S	M	T	W	T	F	S																																																																																																																																																																																																																																																											
1	2	3	4	5	6	7																																																																																																																																																																																																																																																											
8	9	10	11	12	13	14																																																																																																																																																																																																																																																											
15	16	17	18	19	20	21																																																																																																																																																																																																																																																											
22	23	24	25	26	27	28																																																																																																																																																																																																																																																											
29	30	31																																																																																																																																																																																																																																																															
<table border="1"> <tr><td>S</td><td>M</td><td>T</td><td>W</td><td>T</td><td>F</td><td>S</td></tr> <tr><td>1</td><td>2</td><td>3</td><td>4</td><td>5</td><td>6</td><td>7</td></tr> <tr><td>8</td><td>9</td><td>10</td><td>11</td><td>12</td><td>13</td><td>14</td></tr> <tr><td>15</td><td>16</td><td>17</td><td>18</td><td>19</td><td>20</td><td>21</td></tr> <tr><td>22</td><td>23</td><td>24</td><td>25</td><td>26</td><td>27</td><td>28</td></tr> <tr><td>29</td><td>30</td><td>31</td><td></td><td></td><td></td><td></td></tr> </table>	S	M	T	W	T	F	S	1	2	3	4	5	6	7	8	9	10	11	12	13	14	15	16	17	18	19	20	21	22	23	24	25	26	27	28	29	30	31					<table border="1"> <tr><td>S</td><td>M</td><td>T</td><td>W</td><td>T</td><td>F</td><td>S</td></tr> <tr><td>1</td><td>2</td><td>3</td><td>4</td><td>5</td><td>6</td><td>7</td></tr> <tr><td>8</td><td>9</td><td>10</td><td>11</td><td>12</td><td>13</td><td>14</td></tr> <tr><td>15</td><td>16</td><td>17</td><td>18</td><td>19</td><td>20</td><td>21</td></tr> <tr><td>22</td><td>23</td><td>24</td><td>25</td><td>26</td><td>27</td><td>28</td></tr> <tr><td>29</td><td>30</td><td>31</td><td></td><td></td><td></td><td></td></tr> </table>	S	M	T	W	T	F	S	1	2	3	4	5	6	7	8	9	10	11	12	13	14	15	16	17	18	19	20	21	22	23	24	25	26	27	28	29	30	31					<table border="1"> <tr><td>S</td><td>M</td><td>T</td><td>W</td><td>T</td><td>F</td><td>S</td></tr> <tr><td>1</td><td>2</td><td>3</td><td>4</td><td>5</td><td>6</td><td>7</td></tr> <tr><td>8</td><td>9</td><td>10</td><td>11</td><td>12</td><td>13</td><td>14</td></tr> <tr><td>15</td><td>16</td><td>17</td><td>18</td><td>19</td><td>20</td><td>21</td></tr> <tr><td>22</td><td>23</td><td>24</td><td>25</td><td>26</td><td>27</td><td>28</td></tr> <tr><td>29</td><td>30</td><td>31</td><td></td><td></td><td></td><td></td></tr> </table>	S	M	T	W	T	F	S	1	2	3	4	5	6	7	8	9	10	11	12	13	14	15	16	17	18	19	20	21	22	23	24	25	26	27	28	29	30	31					<table border="1"> <tr><td>S</td><td>M</td><td>T</td><td>W</td><td>T</td><td>F</td><td>S</td></tr> <tr><td>1</td><td>2</td><td>3</td><td>4</td><td>5</td><td>6</td><td>7</td></tr> <tr><td>8</td><td>9</td><td>10</td><td>11</td><td>12</td><td>13</td><td>14</td></tr> <tr><td>15</td><td>16</td><td>17</td><td>18</td><td>19</td><td>20</td><td>21</td></tr> <tr><td>22</td><td>23</td><td>24</td><td>25</td><td>26</td><td>27</td><td>28</td></tr> <tr><td>29</td><td>30</td><td>31</td><td></td><td></td><td></td><td></td></tr> </table>	S	M	T	W	T	F	S	1	2	3	4	5	6	7	8	9	10	11	12	13	14	15	16	17	18	19	20	21	22	23	24	25	26	27	28	29	30	31					<table border="1"> <tr><td>S</td><td>M</td><td>T</td><td>W</td><td>T</td><td>F</td><td>S</td></tr> <tr><td>1</td><td>2</td><td>3</td><td>4</td><td>5</td><td>6</td><td>7</td></tr> <tr><td>8</td><td>9</td><td>10</td><td>11</td><td>12</td><td>13</td><td>14</td></tr> <tr><td>15</td><td>16</td><td>17</td><td>18</td><td>19</td><td>20</td><td>21</td></tr> <tr><td>22</td><td>23</td><td>24</td><td>25</td><td>26</td><td>27</td><td>28</td></tr> <tr><td>29</td><td>30</td><td>31</td><td></td><td></td><td></td><td></td></tr> </table>	S	M	T	W	T	F	S	1	2	3	4	5	6	7	8	9	10	11	12	13	14	15	16	17	18	19	20	21	22	23	24	25	26	27	28	29	30	31					<table border="1"> <tr><td>S</td><td>M</td><td>T</td><td>W</td><td>T</td><td>F</td><td>S</td></tr> <tr><td>1</td><td>2</td><td>3</td><td>4</td><td>5</td><td>6</td><td>7</td></tr> <tr><td>8</td><td>9</td><td>10</td><td>11</td><td>12</td><td>13</td><td>14</td></tr> <tr><td>15</td><td>16</td><td>17</td><td>18</td><td>19</td><td>20</td><td>21</td></tr> <tr><td>22</td><td>23</td><td>24</td><td>25</td><td>26</td><td>27</td><td>28</td></tr> <tr><td>29</td><td>30</td><td>31</td><td></td><td></td><td></td><td></td></tr> </table>	S	M	T	W	T	F	S	1	2	3	4	5	6	7	8	9	10	11	12	13	14	15	16	17	18	19	20	21	22	23	24	25	26	27	28	29	30	31				
S	M	T	W	T	F	S																																																																																																																																																																																																																																																											
1	2	3	4	5	6	7																																																																																																																																																																																																																																																											
8	9	10	11	12	13	14																																																																																																																																																																																																																																																											
15	16	17	18	19	20	21																																																																																																																																																																																																																																																											
22	23	24	25	26	27	28																																																																																																																																																																																																																																																											
29	30	31																																																																																																																																																																																																																																																															
S	M	T	W	T	F	S																																																																																																																																																																																																																																																											
1	2	3	4	5	6	7																																																																																																																																																																																																																																																											
8	9	10	11	12	13	14																																																																																																																																																																																																																																																											
15	16	17	18	19	20	21																																																																																																																																																																																																																																																											
22	23	24	25	26	27	28																																																																																																																																																																																																																																																											
29	30	31																																																																																																																																																																																																																																																															
S	M	T	W	T	F	S																																																																																																																																																																																																																																																											
1	2	3	4	5	6	7																																																																																																																																																																																																																																																											
8	9	10	11	12	13	14																																																																																																																																																																																																																																																											
15	16	17	18	19	20	21																																																																																																																																																																																																																																																											
22	23	24	25	26	27	28																																																																																																																																																																																																																																																											
29	30	31																																																																																																																																																																																																																																																															
S	M	T	W	T	F	S																																																																																																																																																																																																																																																											
1	2	3	4	5	6	7																																																																																																																																																																																																																																																											
8	9	10	11	12	13	14																																																																																																																																																																																																																																																											
15	16	17	18	19	20	21																																																																																																																																																																																																																																																											
22	23	24	25	26	27	28																																																																																																																																																																																																																																																											
29	30	31																																																																																																																																																																																																																																																															
S	M	T	W	T	F	S																																																																																																																																																																																																																																																											
1	2	3	4	5	6	7																																																																																																																																																																																																																																																											
8	9	10	11	12	13	14																																																																																																																																																																																																																																																											
15	16	17	18	19	20	21																																																																																																																																																																																																																																																											
22	23	24	25	26	27	28																																																																																																																																																																																																																																																											
29	30	31																																																																																																																																																																																																																																																															
S	M	T	W	T	F	S																																																																																																																																																																																																																																																											
1	2	3	4	5	6	7																																																																																																																																																																																																																																																											
8	9	10	11	12	13	14																																																																																																																																																																																																																																																											
15	16	17	18	19	20	21																																																																																																																																																																																																																																																											
22	23	24	25	26	27	28																																																																																																																																																																																																																																																											
29	30	31																																																																																																																																																																																																																																																															
<table border="1"> <tr><td>S</td><td>M</td><td>T</td><td>W</td><td>T</td><td>F</td><td>S</td></tr> <tr><td>1</td><td>2</td><td>3</td><td>4</td><td>5</td><td>6</td><td>7</td></tr> <tr><td>8</td><td>9</td><td>10</td><td>11</td><td>12</td><td>13</td><td>14</td></tr> <tr><td>15</td><td>16</td><td>17</td><td>18</td><td>19</td><td>20</td><td>21</td></tr> <tr><td>22</td><td>23</td><td>24</td><td>25</td><td>26</td><td>27</td><td>28</td></tr> <tr><td>29</td><td>30</td><td>31</td><td></td><td></td><td></td><td></td></tr> </table>	S	M	T	W	T	F	S	1	2	3	4	5	6	7	8	9	10	11	12	13	14	15	16	17	18	19	20	21	22	23	24	25	26	27	28	29	30	31					<table border="1"> <tr><td>S</td><td>M</td><td>T</td><td>W</td><td>T</td><td>F</td><td>S</td></tr> <tr><td>1</td><td>2</td><td>3</td><td>4</td><td>5</td><td>6</td><td>7</td></tr> <tr><td>8</td><td>9</td><td>10</td><td>11</td><td>12</td><td>13</td><td>14</td></tr> <tr><td>15</td><td>16</td><td>17</td><td>18</td><td>19</td><td>20</td><td>21</td></tr> <tr><td>22</td><td>23</td><td>24</td><td>25</td><td>26</td><td>27</td><td>28</td></tr> <tr><td>29</td><td>30</td><td>31</td><td></td><td></td><td></td><td></td></tr> </table>	S	M	T	W	T	F	S	1	2	3	4	5	6	7	8	9	10	11	12	13	14	15	16	17	18	19	20	21	22	23	24	25	26	27	28	29	30	31					<table border="1"> <tr><td>S</td><td>M</td><td>T</td><td>W</td><td>T</td><td>F</td><td>S</td></tr> <tr><td>1</td><td>2</td><td>3</td><td>4</td><td>5</td><td>6</td><td>7</td></tr> <tr><td>8</td><td>9</td><td>10</td><td>11</td><td>12</td><td>13</td><td>14</td></tr> <tr><td>15</td><td>16</td><td>17</td><td>18</td><td>19</td><td>20</td><td>21</td></tr> <tr><td>22</td><td>23</td><td>24</td><td>25</td><td>26</td><td>27</td><td>28</td></tr> <tr><td>29</td><td>30</td><td>31</td><td></td><td></td><td></td><td></td></tr> </table>	S	M	T	W	T	F	S	1	2	3	4	5	6	7	8	9	10	11	12	13	14	15	16	17	18	19	20	21	22	23	24	25	26	27	28	29	30	31					<table border="1"> <tr><td>S</td><td>M</td><td>T</td><td>W</td><td>T</td><td>F</td><td>S</td></tr> <tr><td>1</td><td>2</td><td>3</td><td>4</td><td>5</td><td>6</td><td>7</td></tr> <tr><td>8</td><td>9</td><td>10</td><td>11</td><td>12</td><td>13</td><td>14</td></tr> <tr><td>15</td><td>16</td><td>17</td><td>18</td><td>19</td><td>20</td><td>21</td></tr> <tr><td>22</td><td>23</td><td>24</td><td>25</td><td>26</td><td>27</td><td>28</td></tr> <tr><td>29</td><td>30</td><td>31</td><td></td><td></td><td></td><td></td></tr> </table>	S	M	T	W	T	F	S	1	2	3	4	5	6	7	8	9	10	11	12	13	14	15	16	17	18	19	20	21	22	23	24	25	26	27	28	29	30	31					<table border="1"> <tr><td>S</td><td>M</td><td>T</td><td>W</td><td>T</td><td>F</td><td>S</td></tr> <tr><td>1</td><td>2</td><td>3</td><td>4</td><td>5</td><td>6</td><td>7</td></tr> <tr><td>8</td><td>9</td><td>10</td><td>11</td><td>12</td><td>13</td><td>14</td></tr> <tr><td>15</td><td>16</td><td>17</td><td>18</td><td>19</td><td>20</td><td>21</td></tr> <tr><td>22</td><td>23</td><td>24</td><td>25</td><td>26</td><td>27</td><td>28</td></tr> <tr><td>29</td><td>30</td><td>31</td><td></td><td></td><td></td><td></td></tr> </table>	S	M	T	W	T	F	S	1	2	3	4	5	6	7	8	9	10	11	12	13	14	15	16	17	18	19	20	21	22	23	24	25	26	27	28	29	30	31					<table border="1"> <tr><td>S</td><td>M</td><td>T</td><td>W</td><td>T</td><td>F</td><td>S</td></tr> <tr><td>1</td><td>2</td><td>3</td><td>4</td><td>5</td><td>6</td><td>7</td></tr> <tr><td>8</td><td>9</td><td>10</td><td>11</td><td>12</td><td>13</td><td>14</td></tr> <tr><td>15</td><td>16</td><td>17</td><td>18</td><td>19</td><td>20</td><td>21</td></tr> <tr><td>22</td><td>23</td><td>24</td><td>25</td><td>26</td><td>27</td><td>28</td></tr> <tr><td>29</td><td>30</td><td>31</td><td></td><td></td><td></td><td></td></tr> </table>	S	M	T	W	T	F	S	1	2	3	4	5	6	7	8	9	10	11	12	13	14	15	16	17	18	19	20	21	22	23	24	25	26	27	28	29	30	31				
S	M	T	W	T	F	S																																																																																																																																																																																																																																																											
1	2	3	4	5	6	7																																																																																																																																																																																																																																																											
8	9	10	11	12	13	14																																																																																																																																																																																																																																																											
15	16	17	18	19	20	21																																																																																																																																																																																																																																																											
22	23	24	25	26	27	28																																																																																																																																																																																																																																																											
29	30	31																																																																																																																																																																																																																																																															
S	M	T	W	T	F	S																																																																																																																																																																																																																																																											
1	2	3	4	5	6	7																																																																																																																																																																																																																																																											
8	9	10	11	12	13	14																																																																																																																																																																																																																																																											
15	16	17	18	19	20	21																																																																																																																																																																																																																																																											
22	23	24	25	26	27	28																																																																																																																																																																																																																																																											
29	30	31																																																																																																																																																																																																																																																															
S	M	T	W	T	F	S																																																																																																																																																																																																																																																											
1	2	3	4	5	6	7																																																																																																																																																																																																																																																											
8	9	10	11	12	13	14																																																																																																																																																																																																																																																											
15	16	17	18	19	20	21																																																																																																																																																																																																																																																											
22	23	24	25	26	27	28																																																																																																																																																																																																																																																											
29	30	31																																																																																																																																																																																																																																																															
S	M	T	W	T	F	S																																																																																																																																																																																																																																																											
1	2	3	4	5	6	7																																																																																																																																																																																																																																																											
8	9	10	11	12	13	14																																																																																																																																																																																																																																																											
15	16	17	18	19	20	21																																																																																																																																																																																																																																																											
22	23	24	25	26	27	28																																																																																																																																																																																																																																																											
29	30	31																																																																																																																																																																																																																																																															
S	M	T	W	T	F	S																																																																																																																																																																																																																																																											
1	2	3	4	5	6	7																																																																																																																																																																																																																																																											
8	9	10	11	12	13	14																																																																																																																																																																																																																																																											
15	16	17	18	19	20	21																																																																																																																																																																																																																																																											
22	23	24	25	26	27	28																																																																																																																																																																																																																																																											
29	30	31																																																																																																																																																																																																																																																															
S	M	T	W	T	F	S																																																																																																																																																																																																																																																											
1	2	3	4	5	6	7																																																																																																																																																																																																																																																											
8	9	10	11	12	13	14																																																																																																																																																																																																																																																											
15	16	17	18	19	20	21																																																																																																																																																																																																																																																											
22	23	24	25	26	27	28																																																																																																																																																																																																																																																											
29	30	31																																																																																																																																																																																																																																																															
<table border="1"> <tr><td>S</td><td>M</td><td>T</td><td>W</td><td>T</td><td>F</td><td>S</td></tr> <tr><td>1</td><td>2</td><td>3</td><td>4</td><td>5</td><td>6</td><td>7</td></tr> <tr><td>8</td><td>9</td><td>10</td><td>11</td><td>12</td><td>13</td><td>14</td></tr> <tr><td>15</td><td>16</td><td>17</td><td>18</td><td>19</td><td>20</td><td>21</td></tr> <tr><td>22</td><td>23</td><td>24</td><td>25</td><td>26</td><td>27</td><td>28</td></tr> <tr><td>29</td><td>30</td><td>31</td><td></td><td></td><td></td><td></td></tr> </table>	S	M	T	W	T	F	S	1	2	3	4	5	6	7	8	9	10	11	12	13	14	15	16	17	18	19	20	21	22	23	24	25	26	27	28	29	30	31					<table border="1"> <tr><td>S</td><td>M</td><td>T</td><td>W</td><td>T</td><td>F</td><td>S</td></tr> <tr><td>1</td><td>2</td><td>3</td><td>4</td><td>5</td><td>6</td><td>7</td></tr> <tr><td>8</td><td>9</td><td>10</td><td>11</td><td>12</td><td>13</td><td>14</td></tr> <tr><td>15</td><td>16</td><td>17</td><td>18</td><td>19</td><td>20</td><td>21</td></tr> <tr><td>22</td><td>23</td><td>24</td><td>25</td><td>26</td><td>27</td><td>28</td></tr> <tr><td>29</td><td>30</td><td>31</td><td></td><td></td><td></td><td></td></tr> </table>	S	M	T	W	T	F	S	1	2	3	4	5	6	7	8	9	10	11	12	13	14	15	16	17	18	19	20	21	22	23	24	25	26	27	28	29	30	31					<table border="1"> <tr><td>S</td><td>M</td><td>T</td><td>W</td><td>T</td><td>F</td><td>S</td></tr> <tr><td>1</td><td>2</td><td>3</td><td>4</td><td>5</td><td>6</td><td>7</td></tr> <tr><td>8</td><td>9</td><td>10</td><td>11</td><td>12</td><td>13</td><td>14</td></tr> <tr><td>15</td><td>16</td><td>17</td><td>18</td><td>19</td><td>20</td><td>21</td></tr> <tr><td>22</td><td>23</td><td>24</td><td>25</td><td>26</td><td>27</td><td>28</td></tr> <tr><td>29</td><td>30</td><td>31</td><td></td><td></td><td></td><td></td></tr> </table>	S	M	T	W	T	F	S	1	2	3	4	5	6	7	8	9	10	11	12	13	14	15	16	17	18	19	20	21	22	23	24	25	26	27	28	29	30	31					<table border="1"> <tr><td>S</td><td>M</td><td>T</td><td>W</td><td>T</td><td>F</td><td>S</td></tr> <tr><td>1</td><td>2</td><td>3</td><td>4</td><td>5</td><td>6</td><td>7</td></tr> <tr><td>8</td><td>9</td><td>10</td><td>11</td><td>12</td><td>13</td><td>14</td></tr> <tr><td>15</td><td>16</td><td>17</td><td>18</td><td>19</td><td>20</td><td>21</td></tr> <tr><td>22</td><td>23</td><td>24</td><td>25</td><td>26</td><td>27</td><td>28</td></tr> <tr><td>29</td><td>30</td><td>31</td><td></td><td></td><td></td><td></td></tr> </table>	S	M	T	W	T	F	S	1	2	3	4	5	6	7	8	9	10	11	12	13	14	15	16	17	18	19	20	21	22	23	24	25	26	27	28	29	30	31					<table border="1"> <tr><td>S</td><td>M</td><td>T</td><td>W</td><td>T</td><td>F</td><td>S</td></tr> <tr><td>1</td><td>2</td><td>3</td><td>4</td><td>5</td><td>6</td><td>7</td></tr> <tr><td>8</td><td>9</td><td>10</td><td>11</td><td>12</td><td>13</td><td>14</td></tr> <tr><td>15</td><td>16</td><td>17</td><td>18</td><td>19</td><td>20</td><td>21</td></tr> <tr><td>22</td><td>23</td><td>24</td><td>25</td><td>26</td><td>27</td><td>28</td></tr> <tr><td>29</td><td>30</td><td>31</td><td></td><td></td><td></td><td></td></tr> </table>	S	M	T	W	T	F	S	1	2	3	4	5	6	7	8	9	10	11	12	13	14	15	16	17	18	19	20	21	22	23	24	25	26	27	28	29	30	31					<table border="1"> <tr><td>S</td><td>M</td><td>T</td><td>W</td><td>T</td><td>F</td><td>S</td></tr> <tr><td>1</td><td>2</td><td>3</td><td>4</td><td>5</td><td>6</td><td>7</td></tr> <tr><td>8</td><td>9</td><td>10</td><td>11</td><td>12</td><td>13</td><td>14</td></tr> <tr><td>15</td><td>16</td><td>17</td><td>18</td><td>19</td><td>20</td><td>21</td></tr> <tr><td>22</td><td>23</td><td>24</td><td>25</td><td>26</td><td>27</td><td>28</td></tr> <tr><td>29</td><td>30</td><td>31</td><td></td><td></td><td></td><td></td></tr> </table>	S	M	T	W	T	F	S	1	2	3	4	5	6	7	8	9	10	11	12	13	14	15	16	17	18	19	20	21	22	23	24	25	26	27	28	29	30	31				
S	M	T	W	T	F	S																																																																																																																																																																																																																																																											
1	2	3	4	5	6	7																																																																																																																																																																																																																																																											
8	9	10	11	12	13	14																																																																																																																																																																																																																																																											
15	16	17	18	19	20	21																																																																																																																																																																																																																																																											
22	23	24	25	26	27	28																																																																																																																																																																																																																																																											
29	30	31																																																																																																																																																																																																																																																															
S	M	T	W	T	F	S																																																																																																																																																																																																																																																											
1	2	3	4	5	6	7																																																																																																																																																																																																																																																											
8	9	10	11	12	13	14																																																																																																																																																																																																																																																											
15	16	17	18	19	20	21																																																																																																																																																																																																																																																											
22	23	24	25	26	27	28																																																																																																																																																																																																																																																											
29	30	31																																																																																																																																																																																																																																																															
S	M	T	W	T	F	S																																																																																																																																																																																																																																																											
1	2	3	4	5	6	7																																																																																																																																																																																																																																																											
8	9	10	11	12	13	14																																																																																																																																																																																																																																																											
15	16	17	18	19	20	21																																																																																																																																																																																																																																																											
22	23	24	25	26	27	28																																																																																																																																																																																																																																																											
29	30	31																																																																																																																																																																																																																																																															
S	M	T	W	T	F	S																																																																																																																																																																																																																																																											
1	2	3	4	5	6	7																																																																																																																																																																																																																																																											
8	9	10	11	12	13	14																																																																																																																																																																																																																																																											
15	16	17	18	19	20	21																																																																																																																																																																																																																																																											
22	23	24	25	26	27	28																																																																																																																																																																																																																																																											
29	30	31																																																																																																																																																																																																																																																															
S	M	T	W	T	F	S																																																																																																																																																																																																																																																											
1	2	3	4	5	6	7																																																																																																																																																																																																																																																											
8	9	10	11	12	13	14																																																																																																																																																																																																																																																											
15	16	17	18	19	20	21																																																																																																																																																																																																																																																											
22	23	24	25	26	27	28																																																																																																																																																																																																																																																											
29	30	31																																																																																																																																																																																																																																																															
S	M	T	W	T	F	S																																																																																																																																																																																																																																																											
1	2	3	4	5	6	7																																																																																																																																																																																																																																																											
8	9	10	11	12	13	14																																																																																																																																																																																																																																																											
15	16	17	18	19	20	21																																																																																																																																																																																																																																																											
22	23	24	25	26	27	28																																																																																																																																																																																																																																																											
29	30	31																																																																																																																																																																																																																																																															
<table border="1"> <tr><td>S</td><td>M</td><td>T</td><td>W</td><td>T</td><td>F</td><td>S</td></tr> <tr><td>1</td><td>2</td><td>3</td><td>4</td><td>5</td><td>6</td><td>7</td></tr> <tr><td>8</td><td>9</td><td>10</td><td>11</td><td>12</td><td>13</td><td>14</td></tr> <tr><td>15</td><td>16</td><td>17</td><td>18</td><td>19</td><td>20</td><td>21</td></tr> <tr><td>22</td><td>23</td><td>24</td><td>25</td><td>26</td><td>27</td><td>28</td></tr> <tr><td>29</td><td>30</td><td>31</td><td></td><td></td><td></td><td></td></tr> </table>	S	M	T	W	T	F	S	1	2	3	4	5	6	7	8	9	10	11	12	13	14	15	16	17	18	19	20	21	22	23	24	25	26	27	28	29	30	31					<table border="1"> <tr><td>S</td><td>M</td><td>T</td><td>W</td><td>T</td><td>F</td><td>S</td></tr> <tr><td>1</td><td>2</td><td>3</td><td>4</td><td>5</td><td>6</td><td>7</td></tr> <tr><td>8</td><td>9</td><td>10</td><td>11</td><td>12</td><td>13</td><td>14</td></tr> <tr><td>15</td><td>16</td><td>17</td><td>18</td><td>19</td><td>20</td><td>21</td></tr> <tr><td>22</td><td>23</td><td>24</td><td>25</td><td>26</td><td>27</td><td>28</td></tr> <tr><td>29</td><td>30</td><td>31</td><td></td><td></td><td></td><td></td></tr> </table>	S	M	T	W	T	F	S	1	2	3	4	5	6	7	8	9	10	11	12	13	14	15	16	17	18	19	20	21	22	23	24	25	26	27	28	29	30	31					<table border="1"> <tr><td>S</td><td>M</td><td>T</td><td>W</td><td>T</td><td>F</td><td>S</td></tr> <tr><td>1</td><td>2</td><td>3</td><td>4</td><td>5</td><td>6</td><td>7</td></tr> <tr><td>8</td><td>9</td><td>10</td><td>11</td><td>12</td><td>13</td><td>14</td></tr> <tr><td>15</td><td>16</td><td>17</td><td>18</td><td>19</td><td>20</td><td>21</td></tr> <tr><td>22</td><td>23</td><td>24</td><td>25</td><td>26</td><td>27</td><td>28</td></tr> <tr><td>29</td><td>30</td><td>31</td><td></td><td></td><td></td><td></td></tr> </table>	S	M	T	W	T	F	S	1	2	3	4	5	6	7	8	9	10	11	12	13	14	15	16	17	18	19	20	21	22	23	24	25	26	27	28	29	30	31					<table border="1"> <tr><td>S</td><td>M</td><td>T</td><td>W</td><td>T</td><td>F</td><td>S</td></tr> <tr><td>1</td><td>2</td><td>3</td><td>4</td><td>5</td><td>6</td><td>7</td></tr> <tr><td>8</td><td>9</td><td>10</td><td>11</td><td>12</td><td>13</td><td>14</td></tr> <tr><td>15</td><td>16</td><td>17</td><td>18</td><td>19</td><td>20</td><td>21</td></tr> <tr><td>22</td><td>23</td><td>24</td><td>25</td><td>26</td><td>27</td><td>28</td></tr> <tr><td>29</td><td>30</td><td>31</td><td></td><td></td><td></td><td></td></tr> </table>	S	M	T	W	T	F	S	1	2	3	4	5	6	7	8	9	10	11	12	13	14	15	16	17	18	19	20	21	22	23	24	25	26	27	28	29	30	31					<table border="1"> <tr><td>S</td><td>M</td><td>T</td><td>W</td><td>T</td><td>F</td><td>S</td></tr> <tr><td>1</td><td>2</td><td>3</td><td>4</td><td>5</td><td>6</td><td>7</td></tr> <tr><td>8</td><td>9</td><td>10</td><td>11</td><td>12</td><td>13</td><td>14</td></tr> <tr><td>15</td><td>16</td><td>17</td><td>18</td><td>19</td><td>20</td><td>21</td></tr> <tr><td>22</td><td>23</td><td>24</td><td>25</td><td>26</td><td>27</td><td>28</td></tr> <tr><td>29</td><td>30</td><td>31</td><td></td><td></td><td></td><td></td></tr> </table>	S	M	T	W	T	F	S	1	2	3	4	5	6	7	8	9	10	11	12	13	14	15	16	17	18	19	20	21	22	23	24	25	26	27	28	29	30	31					<table border="1"> <tr><td>S</td><td>M</td><td>T</td><td>W</td><td>T</td><td>F</td><td>S</td></tr> <tr><td>1</td><td>2</td><td>3</td><td>4</td><td>5</td><td>6</td><td>7</td></tr> <tr><td>8</td><td>9</td><td>10</td><td>11</td><td>12</td><td>13</td><td>14</td></tr> <tr><td>15</td><td>16</td><td>17</td><td>18</td><td>19</td><td>20</td><td>21</td></tr> <tr><td>22</td><td>23</td><td>24</td><td>25</td><td>26</td><td>27</td><td>28</td></tr> <tr><td>29</td><td>30</td><td>31</td><td></td><td></td><td></td><td></td></tr> </table>	S	M	T	W	T	F	S	1	2	3	4	5	6	7	8	9	10	11	12	13	14	15	16	17	18	19	20	21	22	23	24	25	26	27	28	29	30	31				
S	M	T	W	T	F	S																																																																																																																																																																																																																																																											
1	2	3	4	5	6	7																																																																																																																																																																																																																																																											
8	9	10	11	12	13	14																																																																																																																																																																																																																																																											
15	16	17	18	19	20	21																																																																																																																																																																																																																																																											
22	23	24	25	26	27	28																																																																																																																																																																																																																																																											
29	30	31																																																																																																																																																																																																																																																															
S	M	T	W	T	F	S																																																																																																																																																																																																																																																											
1	2	3	4	5	6	7																																																																																																																																																																																																																																																											
8	9	10	11	12	13	14																																																																																																																																																																																																																																																											
15	16	17	18	19	20	21																																																																																																																																																																																																																																																											
22	23	24	25	26	27	28																																																																																																																																																																																																																																																											
29	30	31																																																																																																																																																																																																																																																															
S	M	T	W	T	F	S																																																																																																																																																																																																																																																											
1	2	3	4	5	6	7																																																																																																																																																																																																																																																											
8	9	10	11	12	13	14																																																																																																																																																																																																																																																											
15	16	17	18	19	20	21																																																																																																																																																																																																																																																											
22	23	24	25	26	27	28																																																																																																																																																																																																																																																											
29	30	31																																																																																																																																																																																																																																																															
S	M	T	W	T	F	S																																																																																																																																																																																																																																																											
1	2	3	4	5	6	7																																																																																																																																																																																																																																																											
8	9	10	11	12	13	14																																																																																																																																																																																																																																																											
15	16	17	18	19	20	21																																																																																																																																																																																																																																																											
22	23	24	25	26	27	28																																																																																																																																																																																																																																																											
29	30	31																																																																																																																																																																																																																																																															
S	M	T	W	T	F	S																																																																																																																																																																																																																																																											
1	2	3	4	5	6	7																																																																																																																																																																																																																																																											
8	9	10	11	12	13	14																																																																																																																																																																																																																																																											
15	16	17	18	19	20	21																																																																																																																																																																																																																																																											
22	23	24	25	26	27	28																																																																																																																																																																																																																																																											
29	30	31																																																																																																																																																																																																																																																															
S	M	T	W	T	F	S																																																																																																																																																																																																																																																											
1	2	3	4	5	6	7																																																																																																																																																																																																																																																											
8	9	10	11	12	13	14																																																																																																																																																																																																																																																											
15	16	17	18	19	20	21																																																																																																																																																																																																																																																											
22	23	24	25	26	27	28																																																																																																																																																																																																																																																											
29	30	31																																																																																																																																																																																																																																																															

JC-001-026474

My whole existence is flawed...
You get me closer to god... (NM)

Self-awareness

- Infinite
- Existence
- Knowledge
- Neutrality
- Possibility of Happiness
- Understanding of the everything

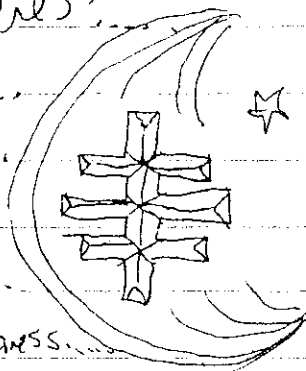

The candle burns...
the stars set the mood...
the smoke fills the room...
the hope is set
then infinite places...
all of purity...

NBK



Please don't show this note to anyone... it was meant only for you.

(Don't tell anyone either)

(You know now)

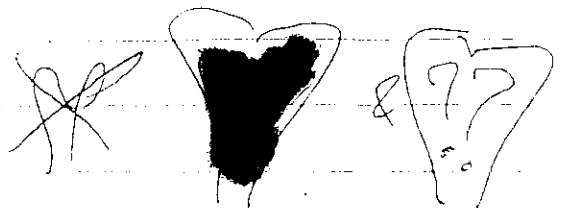

11
11

224

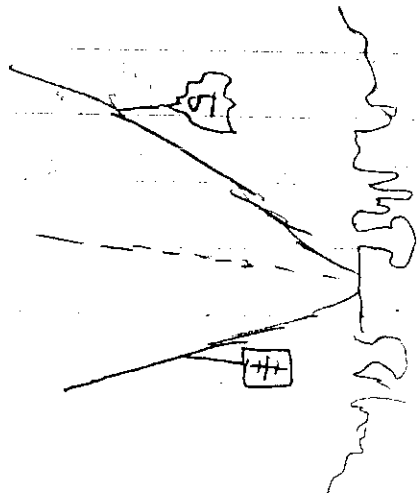
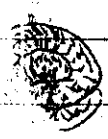



Bar 50

Sorry to see i have made
you sad & i hope
i will turn a happy i will change
love you please love this

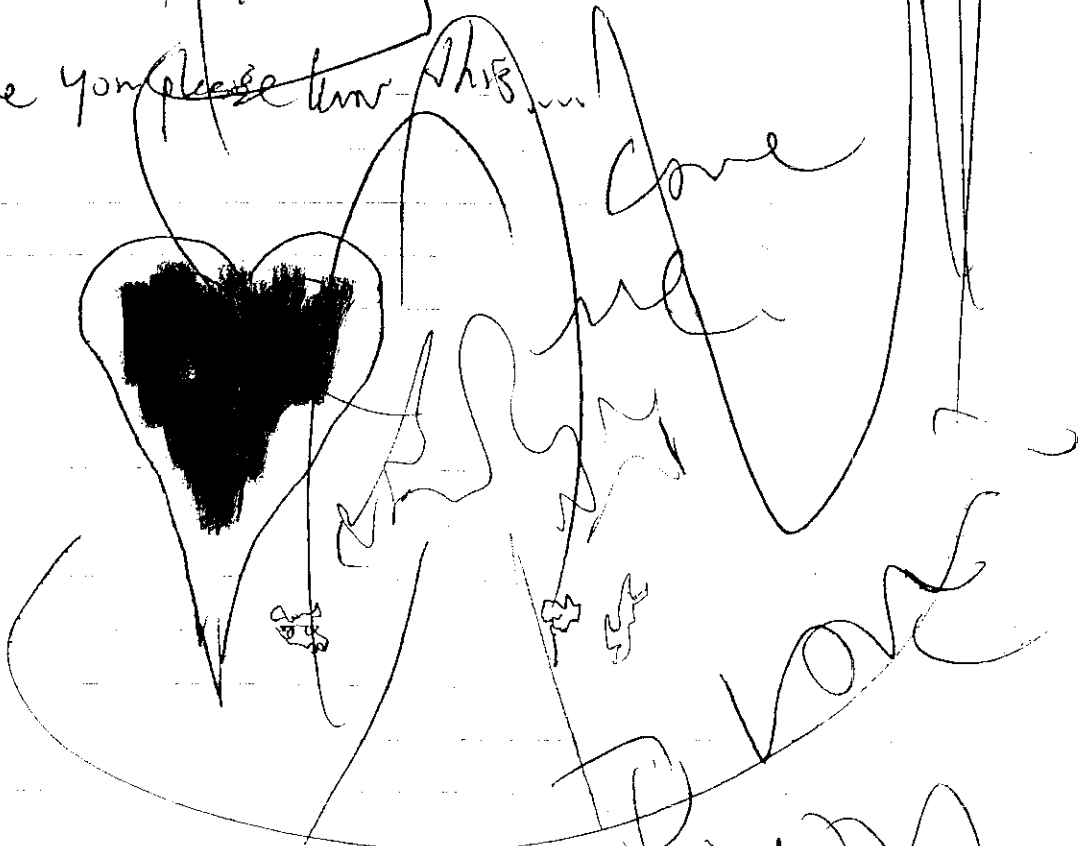

with you
with you

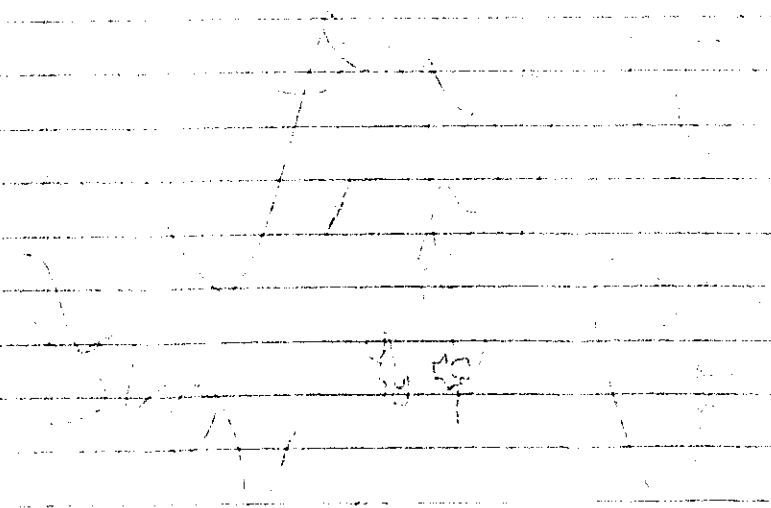
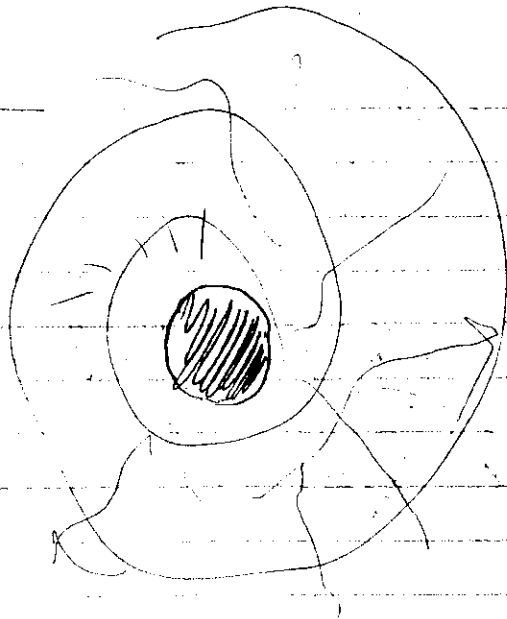

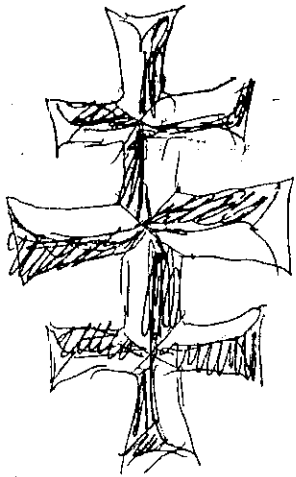
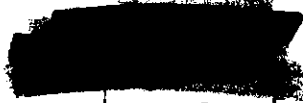

If you don't know who I am I
 still, for I apparently haven't
 been noticeable enough...
 please don't take offense or
 worry about this note... if you
 do know who I am, or if you
 want to anyway, ~~please~~ please

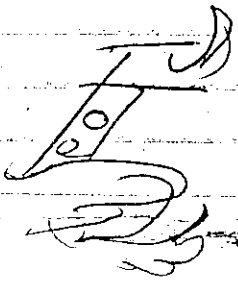

leave a note in my locker saying whatever
 you want - whether that be telling me to
 fuck off or else you'll call the cops, or
 if you want to say whatever, just please
 do me that favor... if you tell me to
 love you again, I will. # 837
 I like you ~~but I~~ but I
 won't force that ever. 170379



ps (I DID say to call you,
 but you must have
 been asleep)

Miss Middle
L
G

JC-001-026480

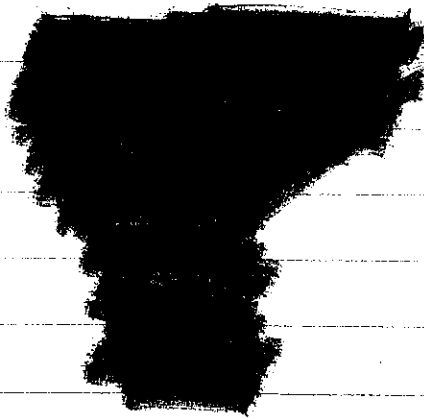

JC-001-026481

In a boring, gay, retarded classroom, there were a bunch of koolies doing some childish writing exercise for ~~the students~~ kindergartners. It was dark outside, there was a grenade launcher on the desk next to the rack wall, & a couple of boxes of ~~the~~ rockets. The spacey teacher made a groaning noise & started to throw globs of flesh at the kids. The kids turned into zombies, & started throwing too. The coolies waited for just the right moment. At last she turned her back, and the coolies sprang into action. Reb grabbed the grenade launcher and began firing at the hideous beast. Suddenly, the zombie wouldn't go down. Marine training kicked in and I dodged to the left avoiding the flesh globs as they smacked against the wall behind me. Tossing a spare rocket to vodka, he shoved it into the zombie-master's back as I, Reb, distracted her by throwing Tombstones at her. Meanwhile, the other coolies were battling the zombified students with their newly founded riot guns. ~~Suddenly~~ All of the sudden a bright light shot out of the sky. There was a huge explosion and tons of black smoke everywhere. One of the koolies stood up to see if anyone had survived. There was nothing to see, everything had disappeared + all that was left was a lonely

Koolio and one riot gun. Since he was
so sad he shot himself.

The humanity of here & now clouds all that
I see, yet the me, the one, can now control
the pain, & it is done. 5 more days. 5

Another influential number, another brick in my
journeyed wall. Humans are zombies, they scratch
for acceptance & greed & kill themselves
from each other. They will never learn, or maybe
they will, but won't have the strength to learn.
To be aware is not a trait, it's a godlike thing
blessed to 2, not a christian, jesus, moh, sarai,
Abraham, David, bible gay shit god, but a true
controller of existence.  was to make us this way.

These moments will ~~be~~ be lost in the depressions
& covers of the human books forever, like tears, in
rain, but the thoughts will be eternal. To explain
the happiness is impossible even for fate, it's just
a pure halcyon set to last more existences than
a conceivable number. Stupid gay nigger humans think
in "crazy" or they think in childish. hahaha, because
i can't solve $\int \sin^2 x \cos^3 x dx$. That makes me dumb!
Because i can't stop thinking in a 2nd dimension, i go
to the 5th! hahaha. so i wait 5 more days. 5 more days.
5 eternities, & i know he & i are all concerned from
ourselves & each other, every night of the self-awareness

journey, every thought we conceived, we have finished
the race. Time to die, everything we knew
we were able to understand it, to perceive it, into
what we should, everything we knew, we know &
see, ~~at~~ an understanding of the everything. An
Einstein stuck in an ant's body, we are the nature
of existence. The zombies were a test to see
if our love was genuine. We are in wait of our
reward, each other. The zombies will never cause us pain
any more. The humanity was a test. I love you, love.
Time to die, time to be free, time to love.

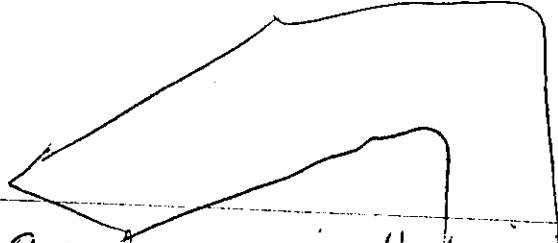

one day, one is the beginning, ? the end. hahaha.
reversed, yet true. About 26.5 hours from now the
judgement will begin. Difficulty but not impossible,
necessary, nerve-racking & fun.

What fun is life without
a little death?

It's interesting, ~~to~~ when i'm in @ my human
form, knowing i'm going to die. Everything
has a touch of triviality to it, like how
none of this calculus shit matters the way
it should. The truth. In 26.4 hours, i'll
be dead, & in happiness. The little zombie
human bags will know their errors, & be
forever suffering & sorrowful, HAHHAHA, of course
i will miss things, not really.

Dylan K 66617
?->? T?
will

Will

Ok, this is my will. This is a fucking human thing to do, but whatever.

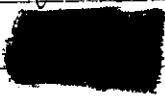
 - you were a badass, never failed to get me up when i was down. Thx you get

FIRST

27 PB's:

V → 1 or 2 greens w. crickets attached

→ All pocket crickets

→ 1 Charlie

3 alpha

2 beta

3 delta

1 extra

1 echo

— in BP →

sample bottles

or

505

oil &

in corner

pouch.

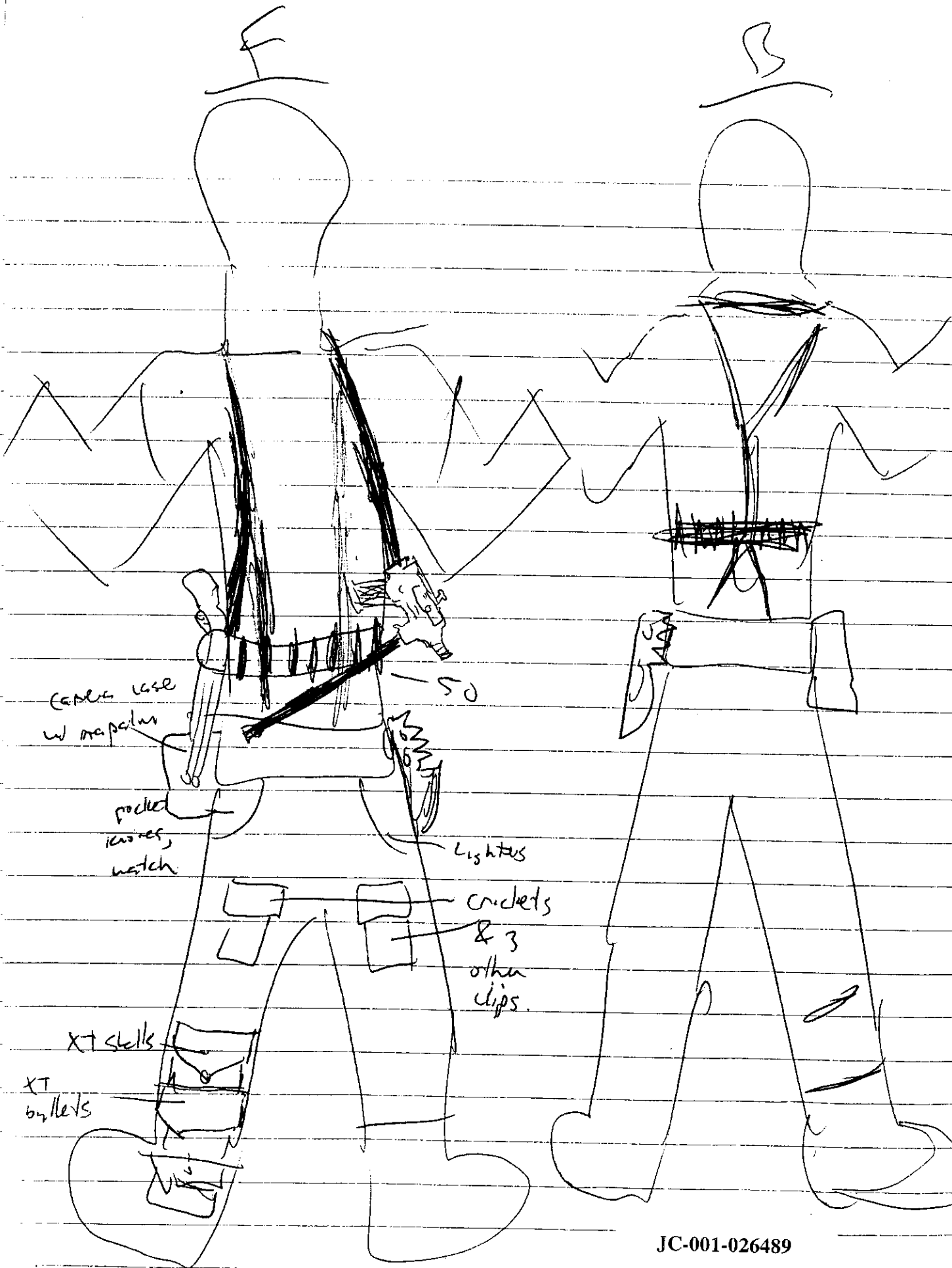

CAMERA case
w/ map pen

pocketed
tissues,
watch

Lighters

crickets
& 3
other
clips

XT shells

XT
bullets

50

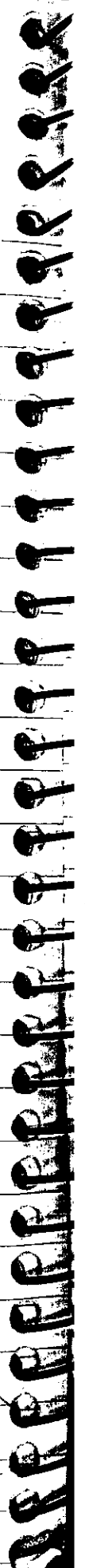

walk in, set bombs at 11:09, for 11:17

leave, set ~~car bombs~~

Drive to denette park. Gear up.

Get back by 11:15

Park cars, set car bombs for 11:18

get out, go to outside hill wait.

when first bombs go off, attack.

have fun!

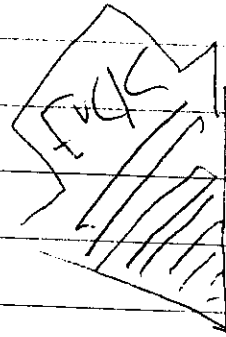

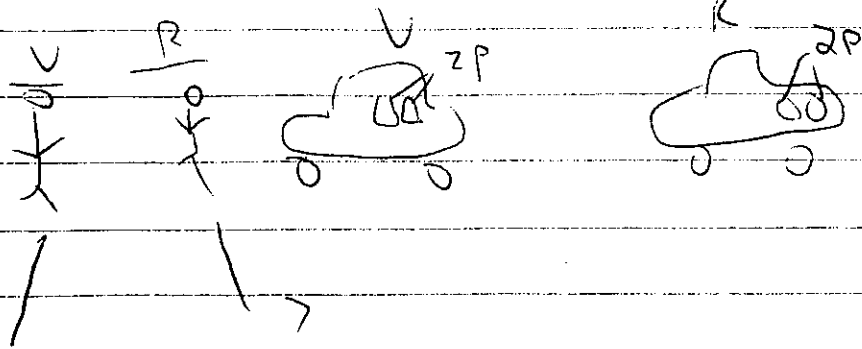

BP, with...

Phombs
 resp. ~~to~~ gas/oil tanks → Duffel bags...

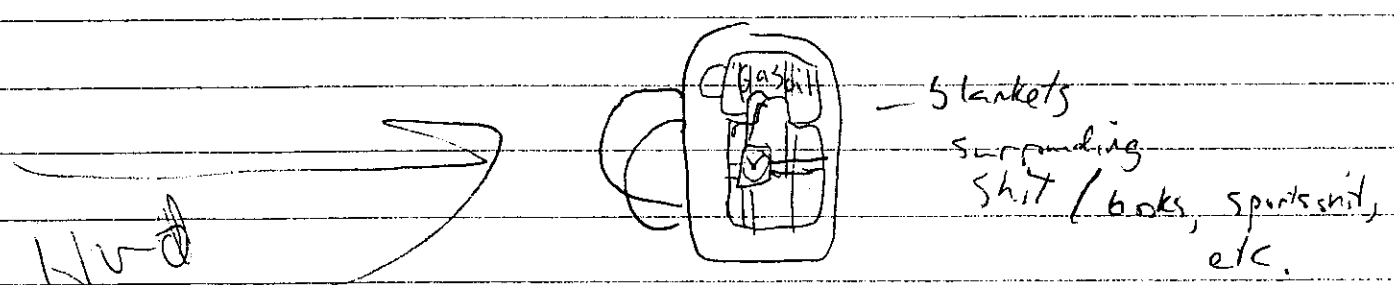

Hand
 to also

After lunch starts - more ppl,
more over.

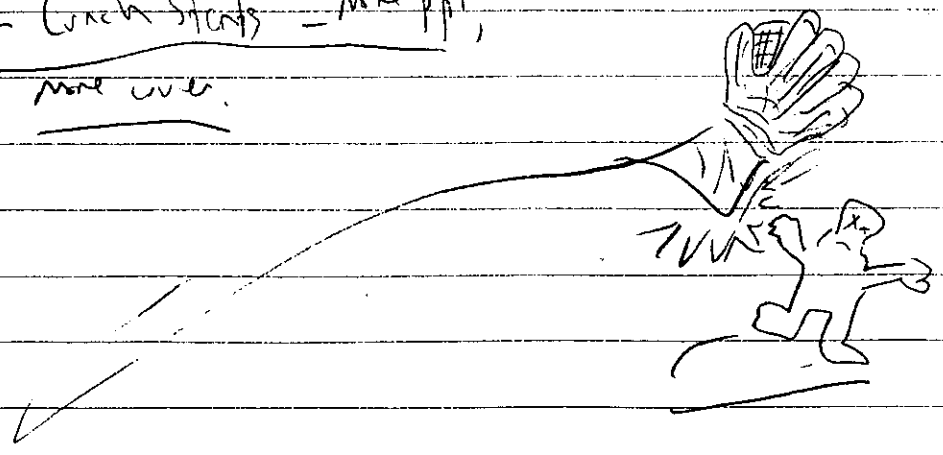

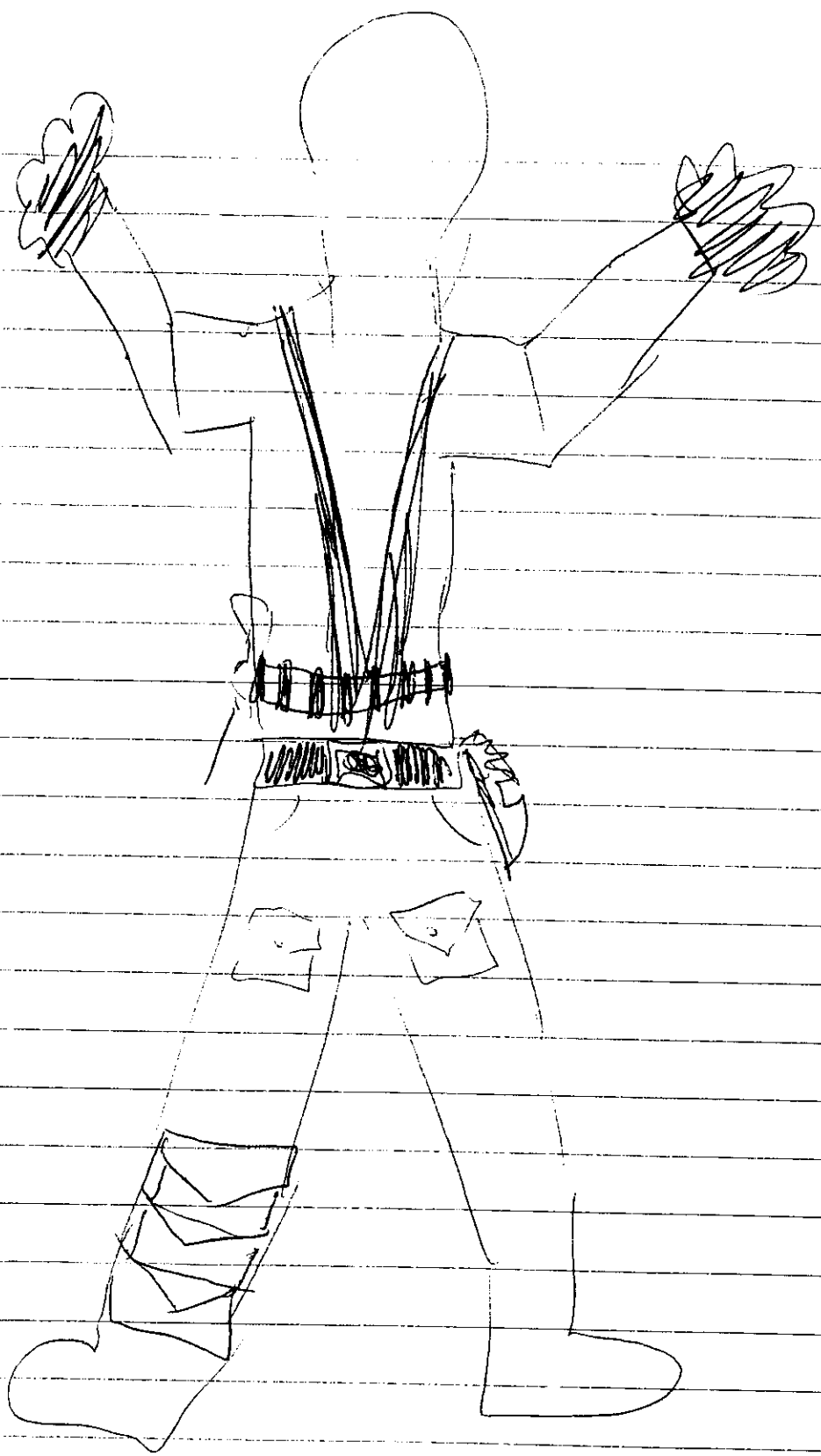

JC-001-026492

The document described below
has been removed

Description of Document: Dylan
Klebold's 1998 Columbine High School
Yearbook (removed with the exception
of Eric Harris' writings to Dylan
Klebold)

Date of Document: 1998

Reason for Removal

- Copyright
- Bomb-making instructions
- Medical Records
- Other

Comments: No adequate means to redact
notes written on pictures of students.

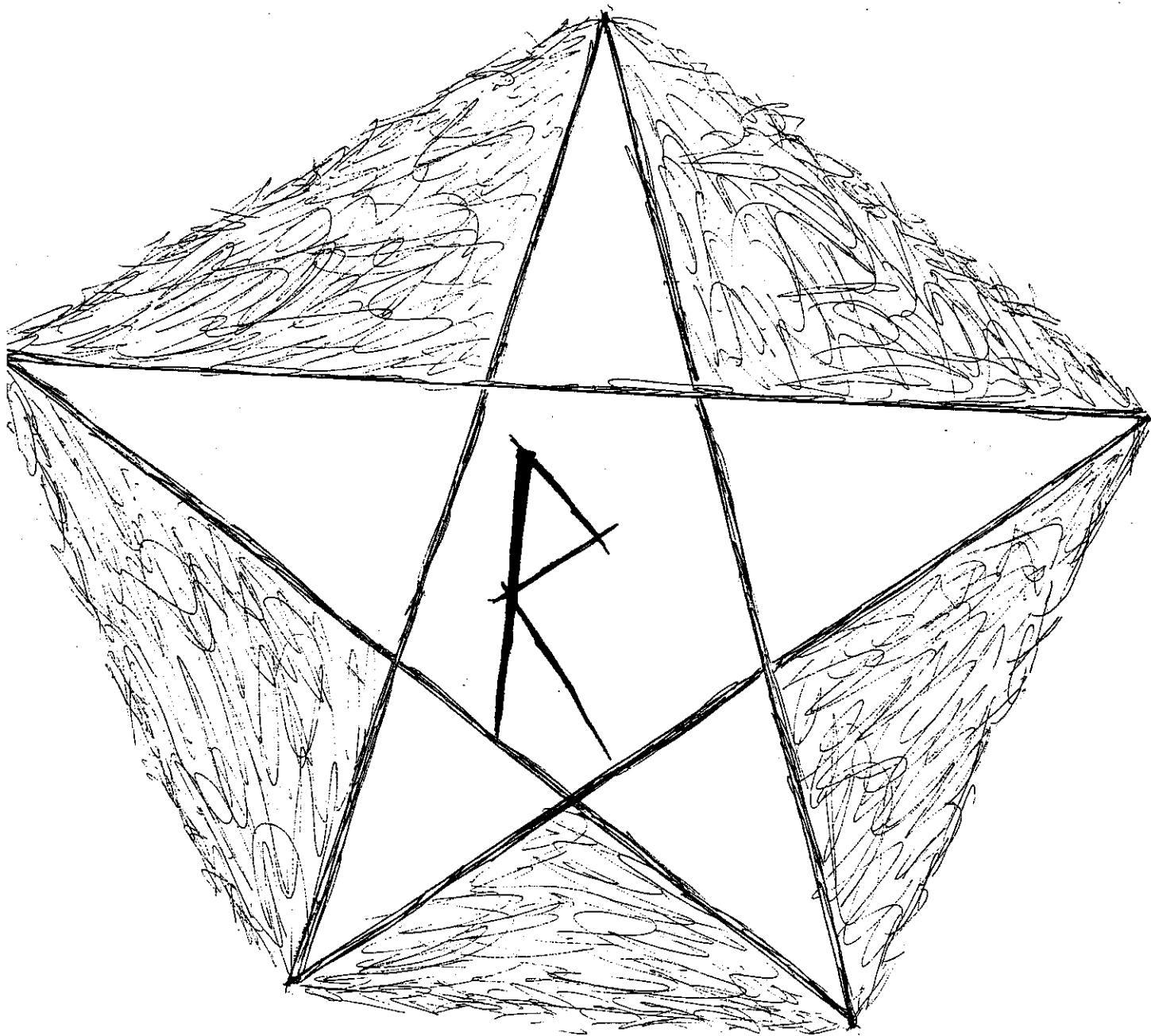

JC-001-026493

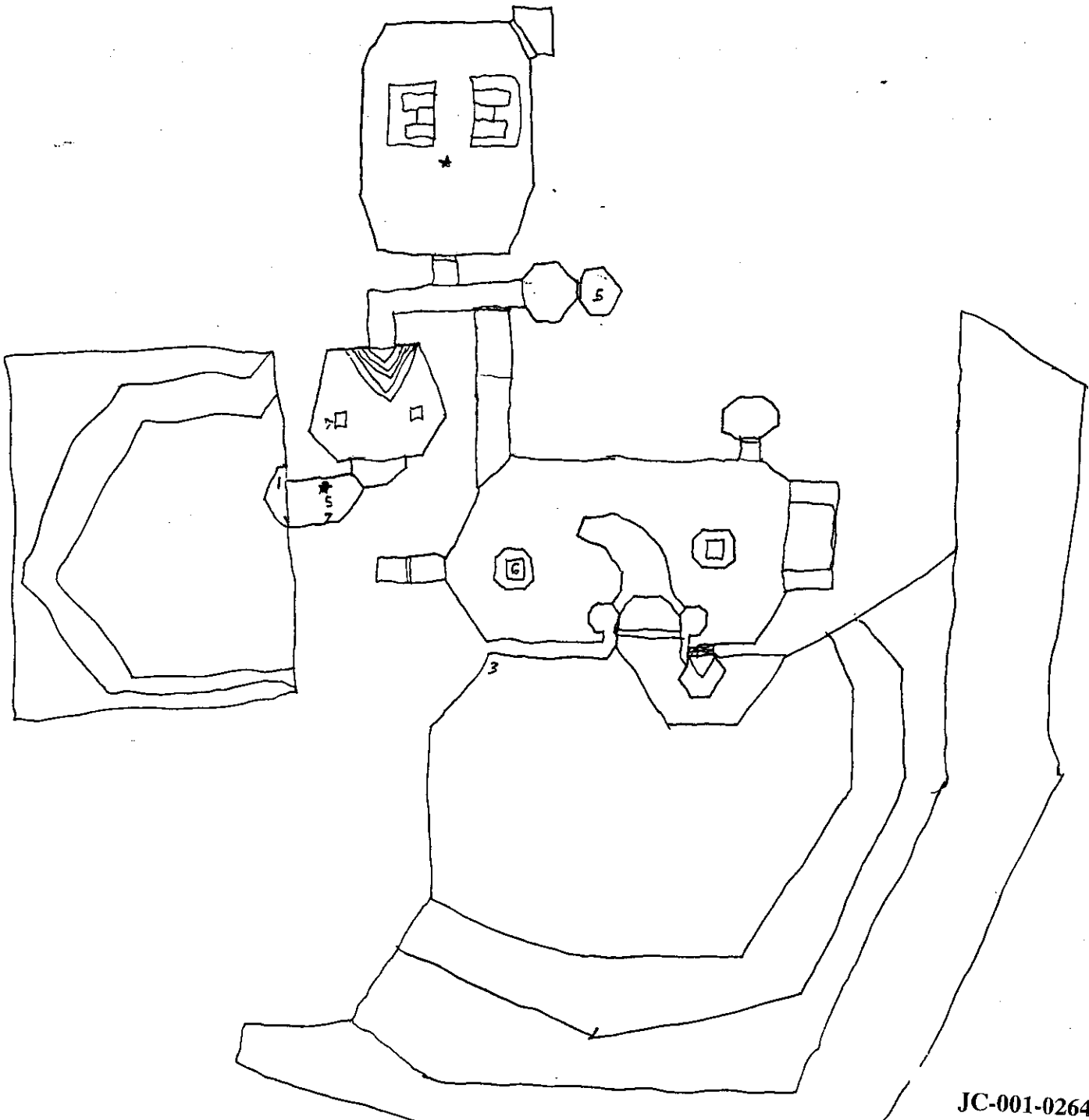
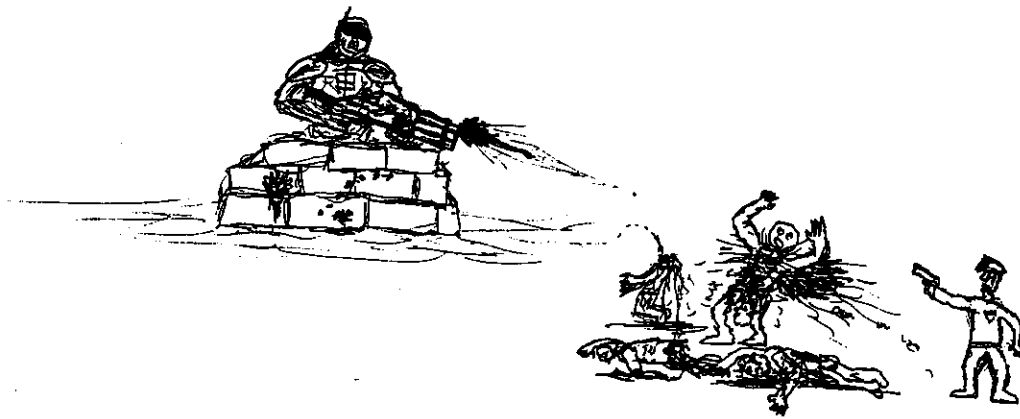

SUPA

NIGGA!

ALLEN

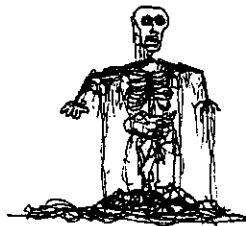
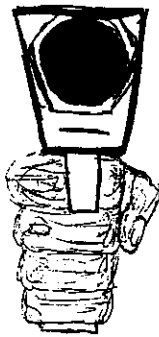

WAS! tust du?

WAS! fühlst du?

WAS! bist du?

DOCH NUR

EIN MITTE

VODKA

Where to start... Jan 31 sux. I hate white vans!! Yeaah!
 KMFD... RAMPTIEN... jeya. the 4th. Atlanta,
 Phobus... petro...pazzie... crickets... + I ER...

DOOM I wish I lived in Doom... BB#3!! Tenman and his
 godlike creations. Station... Realdoom... thrasher

Bricks... Truechaanmp! Map01. Slimjims... salsa seeds...
 our RLs... RMs... ~~██████████~~ is a fuckin traitor/asshole/
 dick now... he might even go on my list... ~~██████████~~ ooh
 God I cant wait till they die. I can taste the blood now... NPK
 und KMEDM... You know what I HATE!!? ... MANKIND!!!
 yeaAAAAAFFFH! Kill everything... kill everything... big slimjims!

Deathmatch! servers! BACKPACK!! MST3K... and of course... I think
 she likes us!
 ah hell, you know
 at that shit

now lets kill
 that fucking
 band



so why say
 it...
 Lets go piss
 off the natives



inny vamp

Do you believe
 in fate?

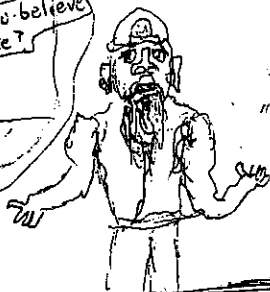

Juvey
 "Bastards"



Phobus
 Deimos
 HOE



Woo
 HAH

EREDS

I think they need to die...

RAMPART

Angelos

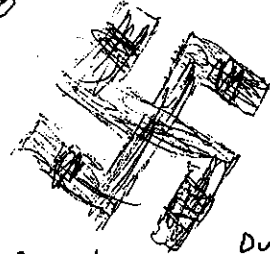

Barrels!

Duct
 tape

orbit 4
 cord

zippe

perfect
 drug against
 war
 weisses FLEISCH!

FIRE

Wilder
 wein

JAC-DEAD
 looker

OPTIA

UAE
 LABS

4<IENIDE

whiskey.wad



Wollt ihr das
 Welt in flammen
 sehen?

Loft wiss id will be a Engel so
 more of the reason your sti
 its the only reason your sti
 becaue some
 decider

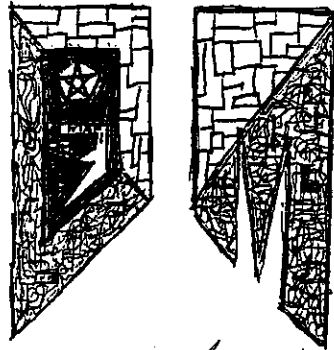
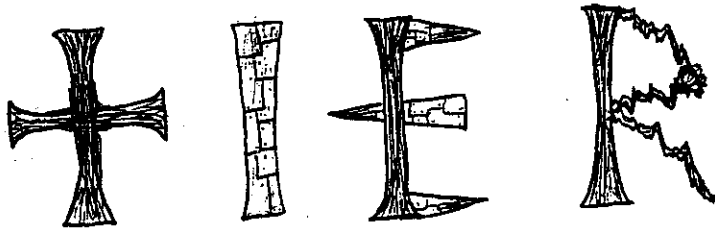
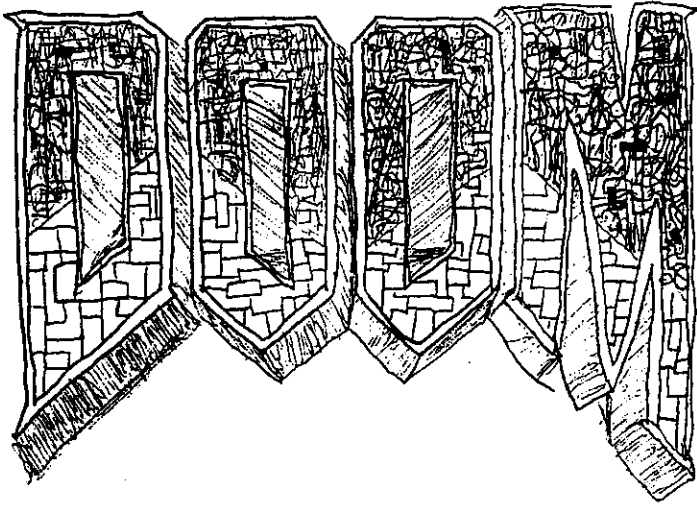

orbital

KAMMSTEIN

1 2 3
4 5 6
7 8 9
X 0 #

CC 11
1 2 3
4 5 6
7 8 9
X 0 #

25¢
10¢
5¢

733

2000
90ms
90ms

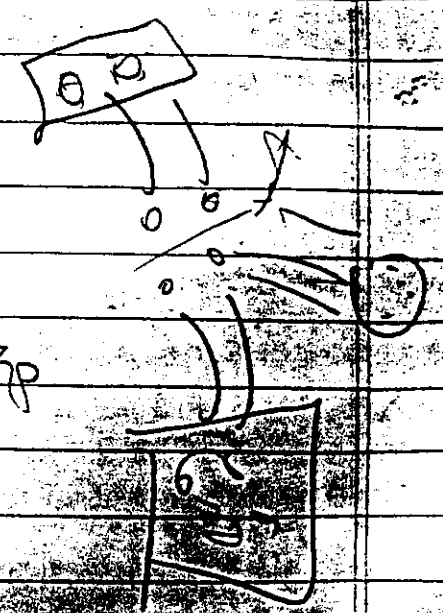

st KD
stp stop stop



* power on/off wired
* in plane jack
? Chass

* mic on/off wired

? mute wired Installation * KEY maybe

* mod. jack
on outside
of bitch

Needs: Black Box hookup

3x2 Toggle for
receiver
3x2 Toggle for
battery...

3 drywall screws
fix elastic holder
fix mute circuit
tape recorder

* supplies
* slots

speaker box hookup
put springy cord & holder for mic
fix mic

447 mini strippers/clippers
~~Setup~~ Setup toggle for recorder/input d.
get wire
clean out

Maybe needs
extra
rewiring

Also...

Blue, Red, Silver, Green Box, cut
free greater than certain tones like

death - Urine Box
lead - Glass Box

transmitter - Lunch Box
Roller Box - music i. out
Silver Box
puncture pad

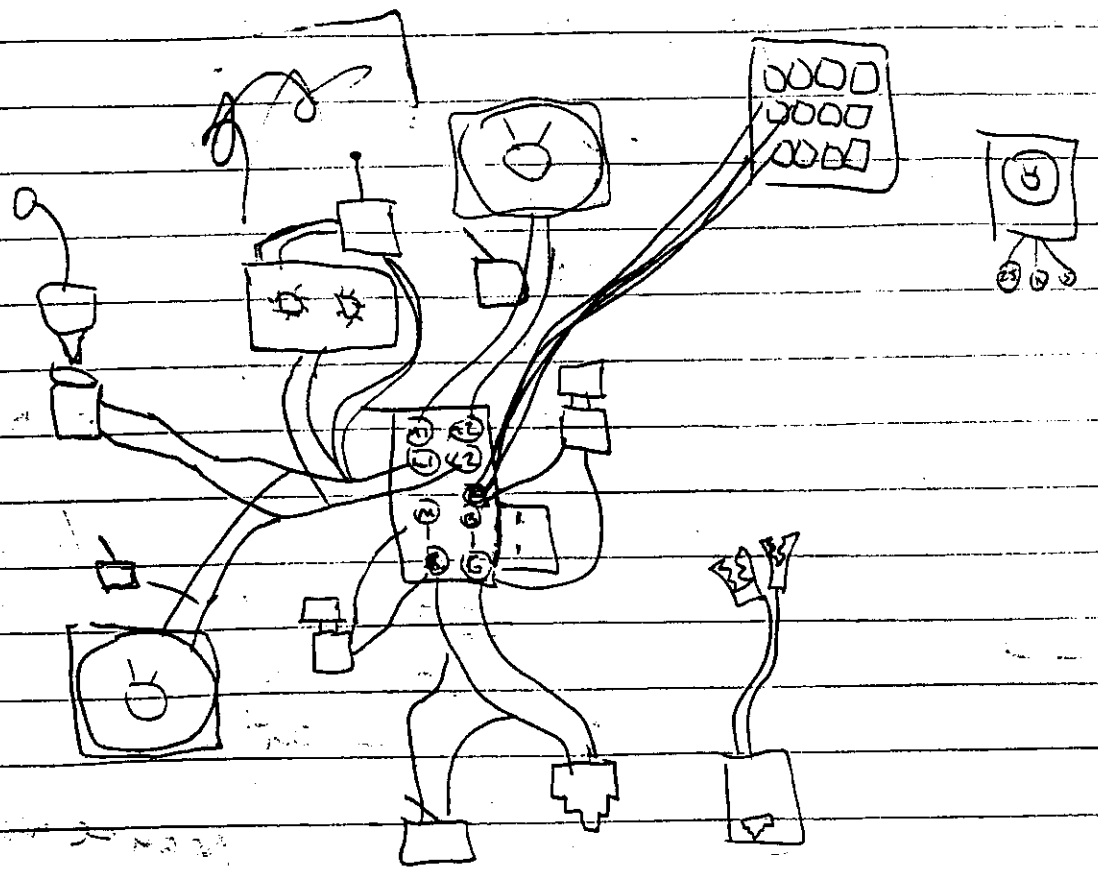
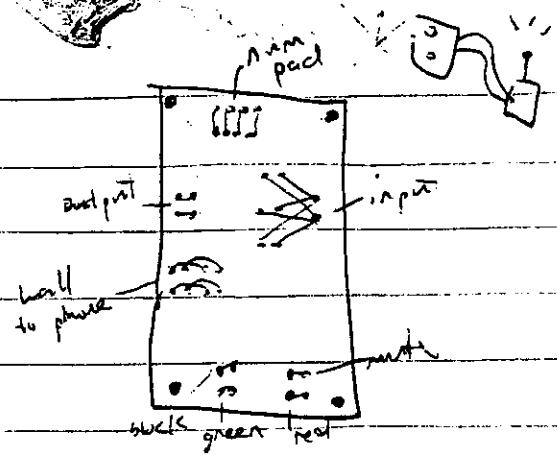
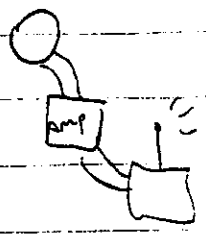

VCO CONSTRUCTION

=== =====

TOOLS REQUIRED

- 1 Oscilloscope (optional but not req)
- 1 Freq. counter (REQUIRED)
- 1 Volt meter " " "
- Electronics tools (Pliers, drill, screwdrivers, etc.)

! \$-PARTS-\$!

- R1 1.5K RESISTOR 5%
- R2 1K RESISTOR 5%
- C1 .1uf ELECTROLYTIC CAPACITOR 16VDC.
- C2 .01uf " " (MYLQR)16VDC.
- IC1 2207 VCO CHIP BY EXAR ELECTRONICS.
- Remember the above only says VCO#1 but the same is for VCO#2
- R3-R4 150 OHM RESISTORS 5%
- C3-C4 .1 uf ELECTROLITIC CAPACITOR 10VDC
- P1-P10 200K TRIMMER POT - 20 TURNS
- DIODES USED IN THE KEYBOARD ARE IN914 TYPE (40 OF THEM)
- 13 SWITCHES FOR THE KEYBOARD SPST MOMENTARY.
- SPKR=YOU CAN USE A TELEPHONE SPEAKER.

FOR THIS (IT WORKS BEST) BUT REMEMBER TO TAKE OUT THE DIODE THAT IS CONNECTED ACCROSS IT.

* * * * *

! *IMPORTANT NOTES* !

* * * * *

- 1. DO NOT USE ANYTHING ELSE OTHER THAN A MYLAR CAPACITOR FOR C2.
- 2. PINS 10,9,8 SHOULD BE TIED TOGETHER AND BE LEFT FLOATING.
- 3. ALL RESISTORS SHOULD BE 5%! NOTHING ELSE!
- 4. A TELEPHONE SPEAKER GIVES THE BEST RESULTS.

* * * * *

%%%%%%%%%

Handwritten signature or stylized text at the top of the page.

- remnant scream
 - human die
 - DB load
 - Romeo - reverse & regular
 - match talk radio
 - sut
 - die hi
 - first notes of lev. I
 - baron death
 - holy shit (headpart)
 - ~~XXXXXXXXXX~~
 - ~~sm~~ sphere
 - Damon walking
 - spider 1st look
- wall push
 - door
 - a has ^{rocks} 'rock' - maddies all over - diff. sounds
 - dark boxes fall
 - eric's god gun power up
 - Lyon snare
 - muller
 - new sh/gun
 - new shock
 - pick up armor
 - pick up gun
 - Magnets res/obam

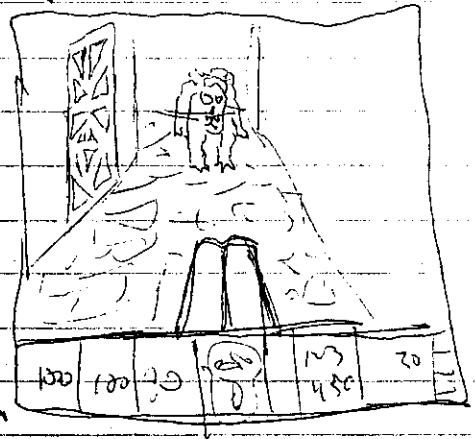

Time of 4 =

8

Handwritten musical notation on a staff, including rhythmic markings (xx, x, xv) and chord symbols (B, BB, B, BF, SBB).

Handwritten musical notation on a grand staff (treble and bass clefs), showing notes and chords (F, C, A, G, F, E, D, C, B, A, G, E, E).

set 2
 Lev. 1 base melody first 4 bends repeated

EMBN1 (w) first 4 bends...
 fans out
 narrow
 (spread down)

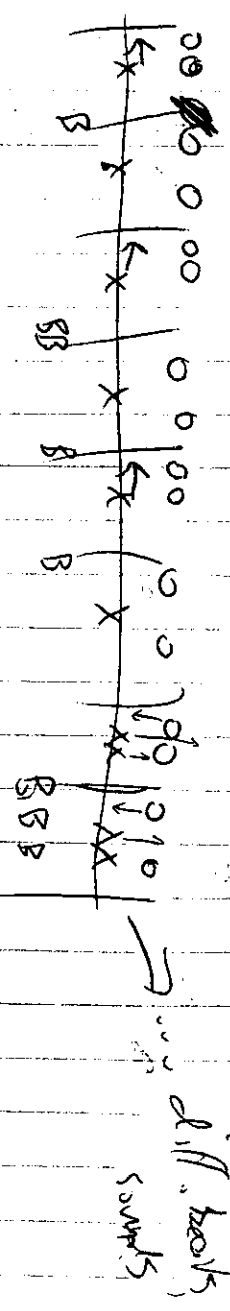

parts of notes: spread widely bends, fan, cluster, wide diameter,
 near the words, orbital,

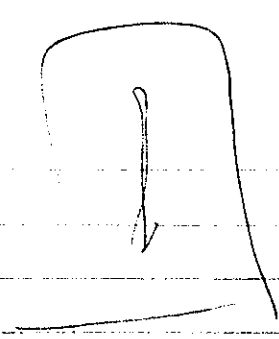

EMBN1 (w)

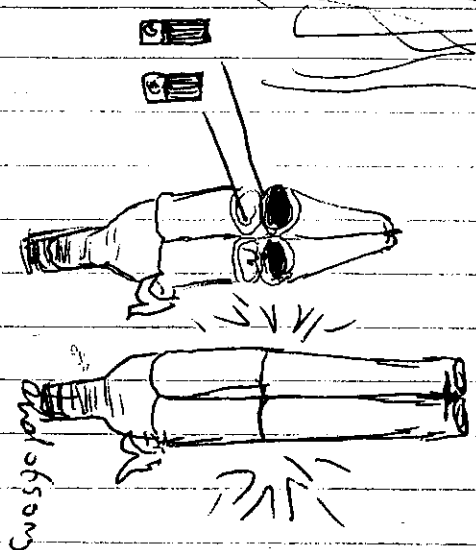

analysis song
 power time length
 follow deep pitch

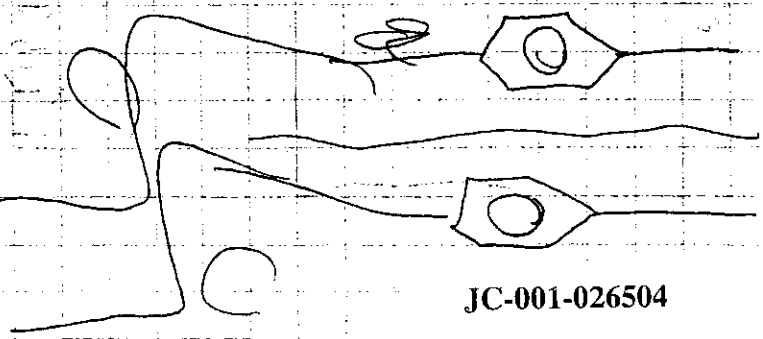
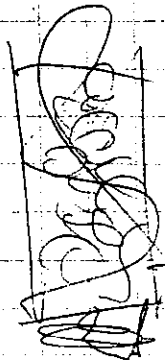
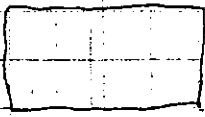
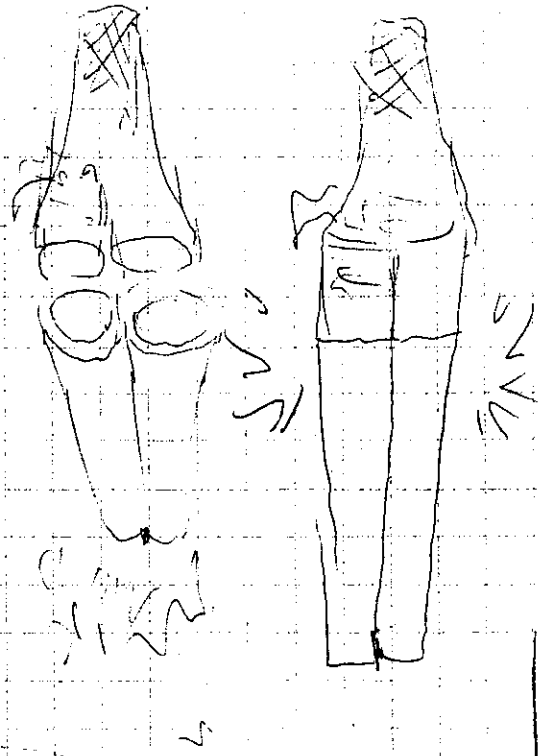
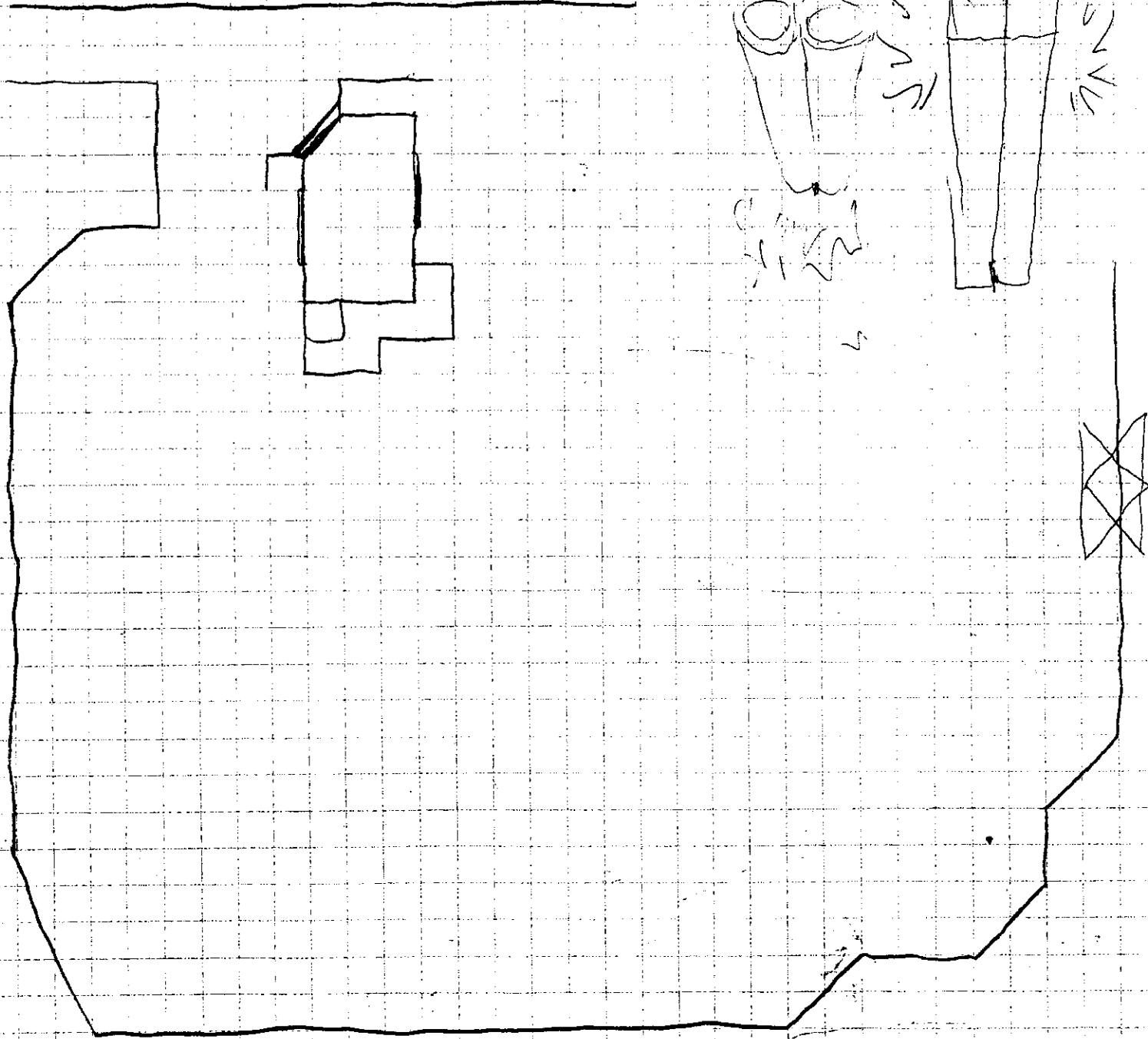

JC-001-026504

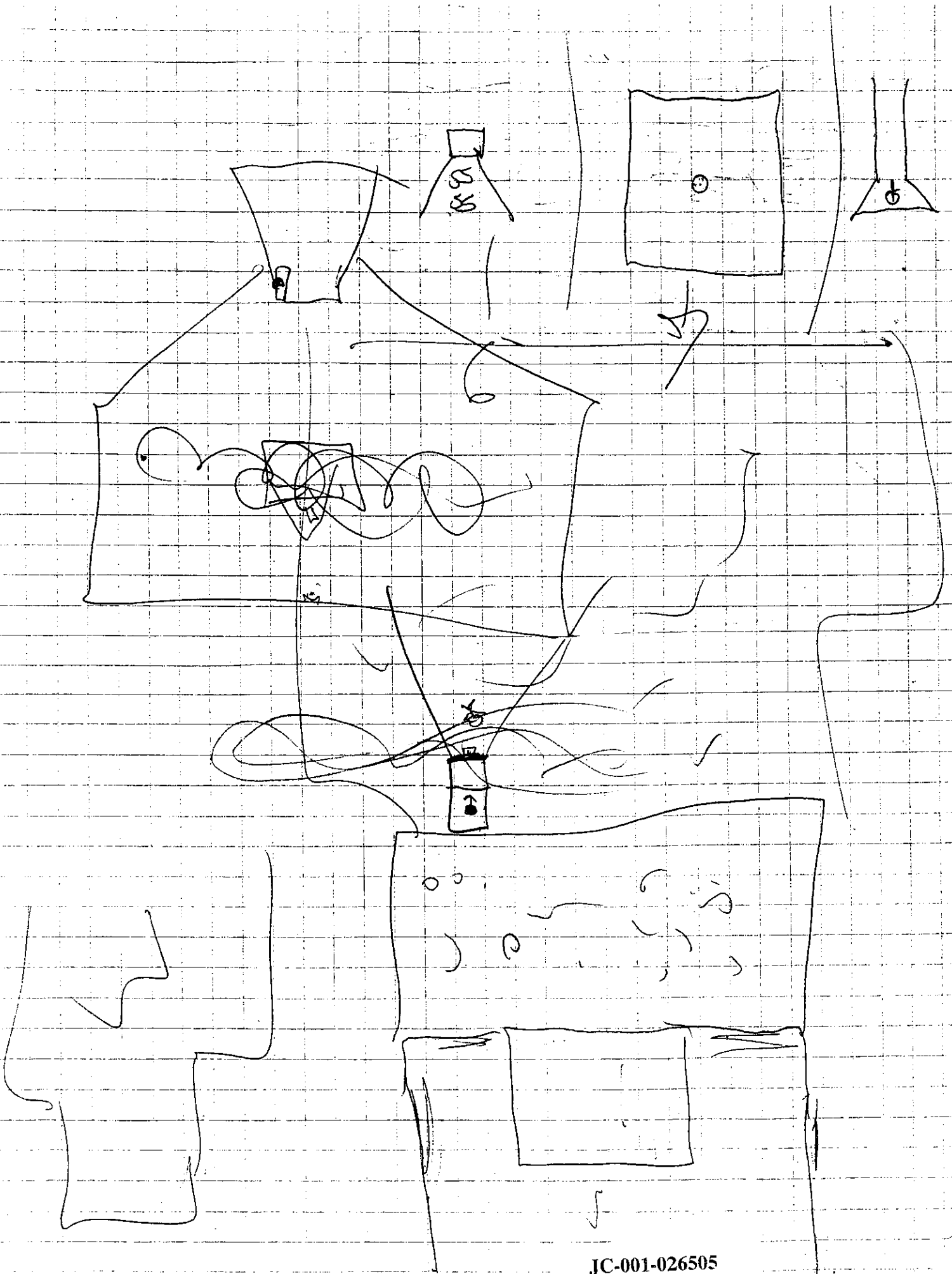

JC-001-026505

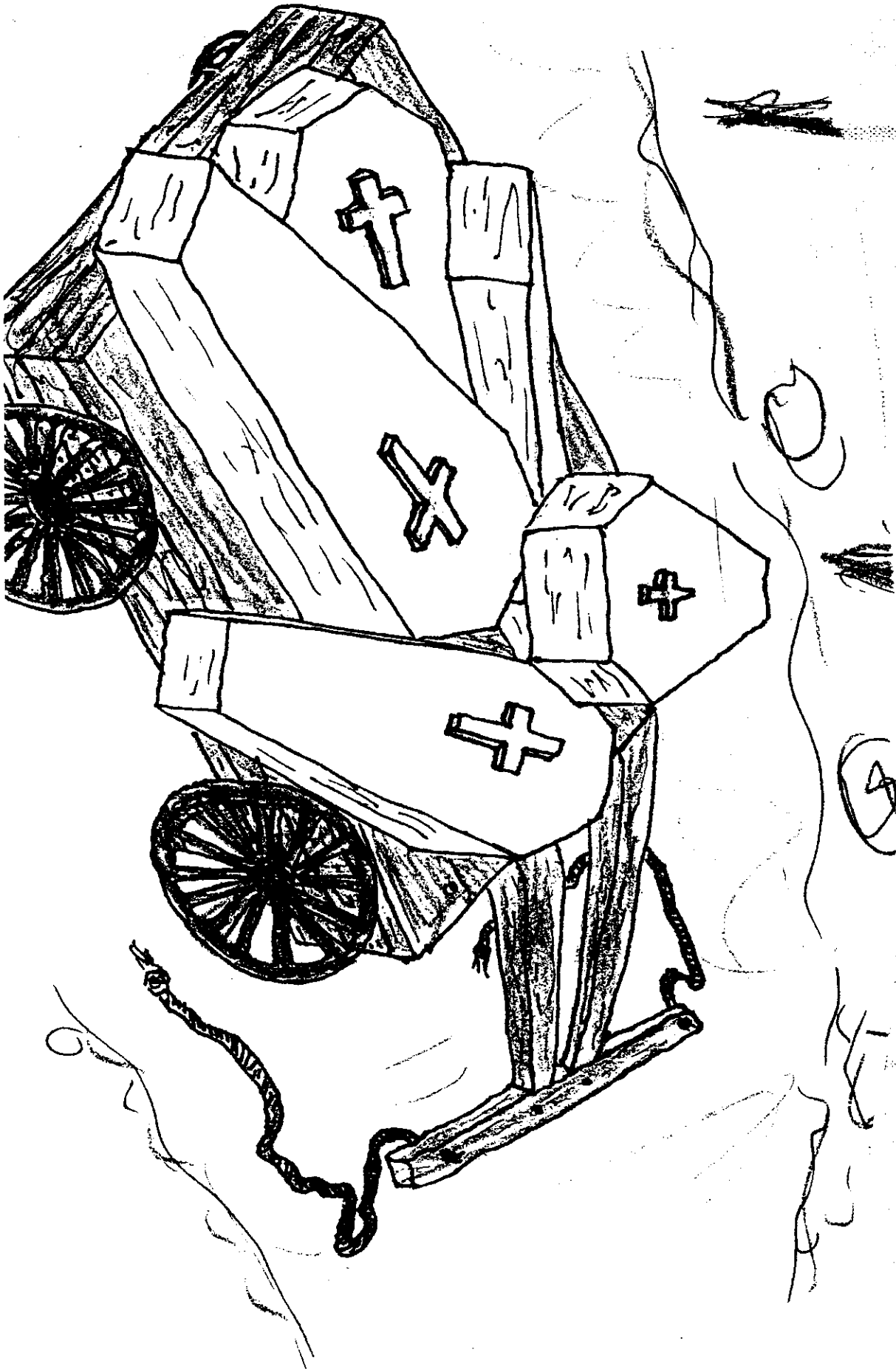

ASSIGNMENTS

~~enemy (finger # for dir)~~
~~hold fire~~
~~have destination~~
~~take cover~~
~~fall back~~
~~fill in me~~
~~self destruct (Signer will do)~~
~~Bombs away (so)~~

AFTER SCHOOL PLANNING

4
5
6
7
8
9

SUNDAY

11

energy-dist (6 or
hand
make my)

hold fire - ^{up} ₃ (msg-10,20,
fl.-dist)

suicide - gun to head

bullet - ^{msg} ₃

over → ₃

land - ₃ ↓
victory scream

over
fire → ₃

Bomb - first wave

happy

1

7

th

b-day

WYLD

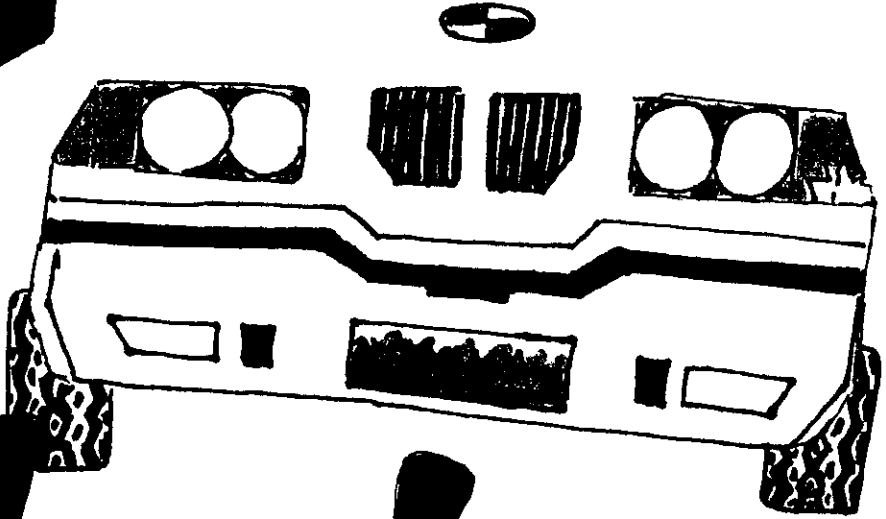
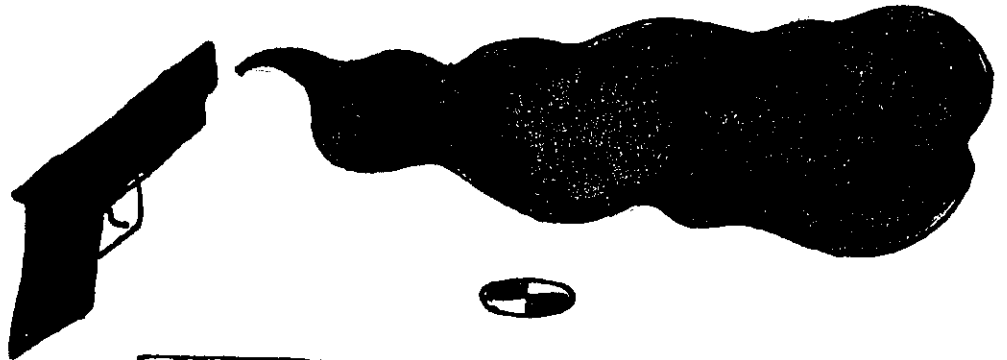

but I figured that you'd
like it. A little Crew Pose,
a little Q.T., a little
[redacted], a little you and a little me!
Happy birthday my
very fan-TASTIC friend.
hehe hehe

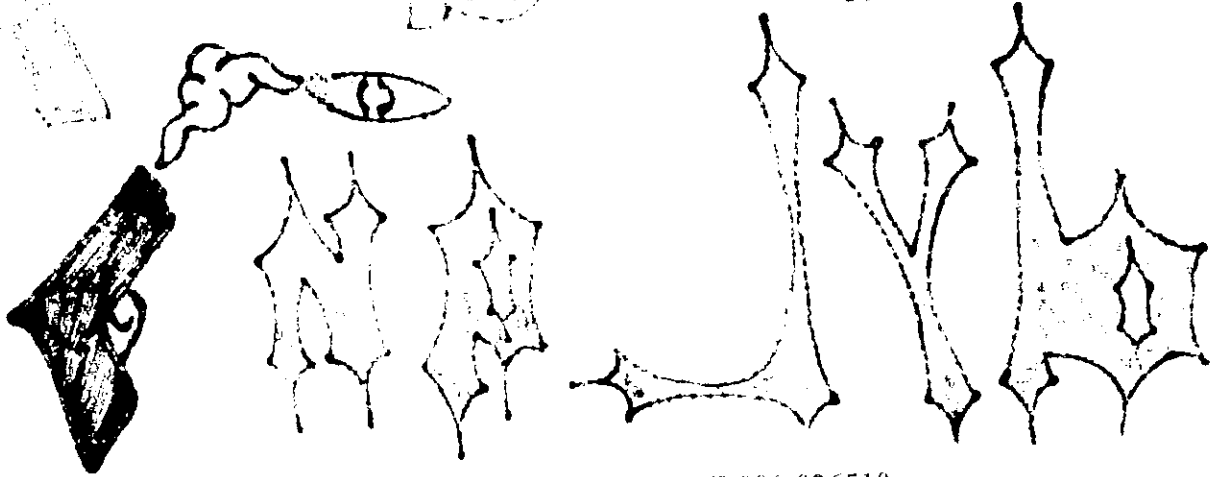
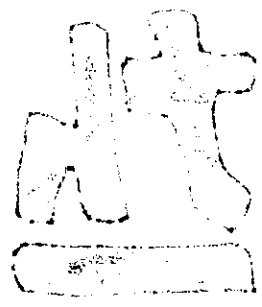
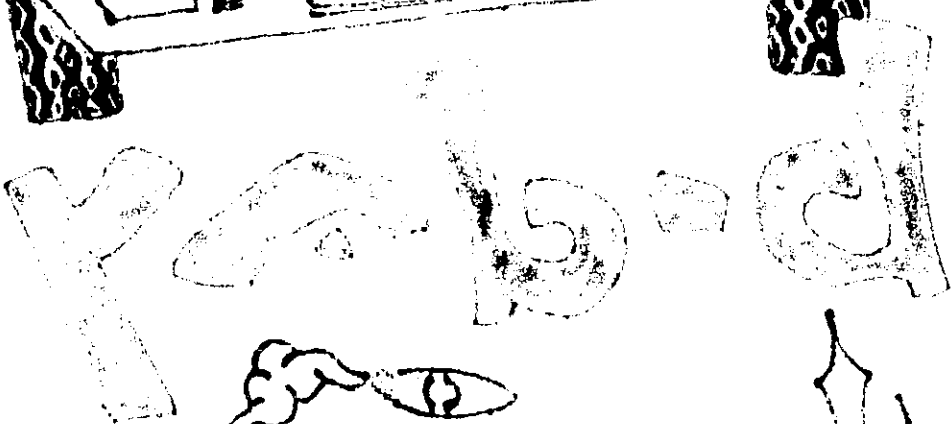
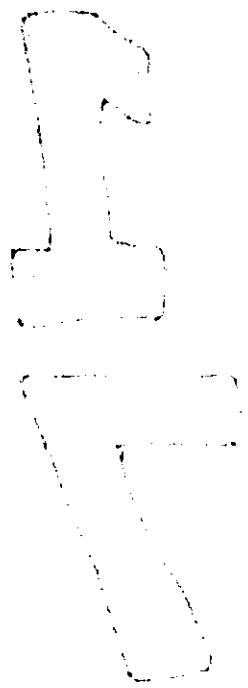
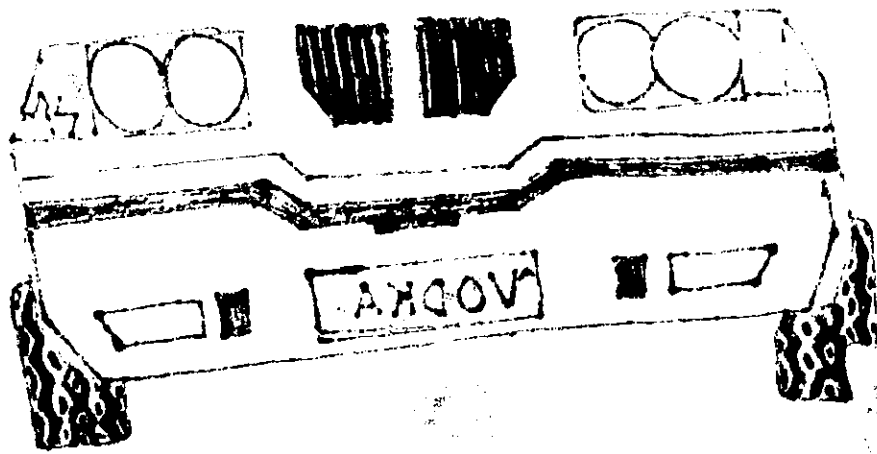
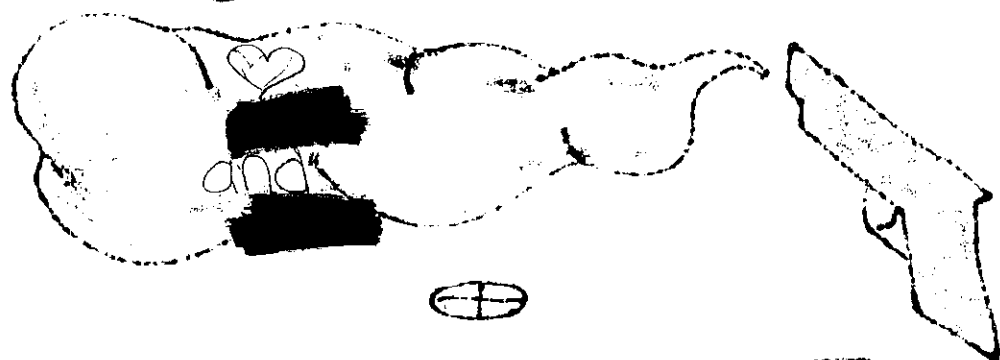
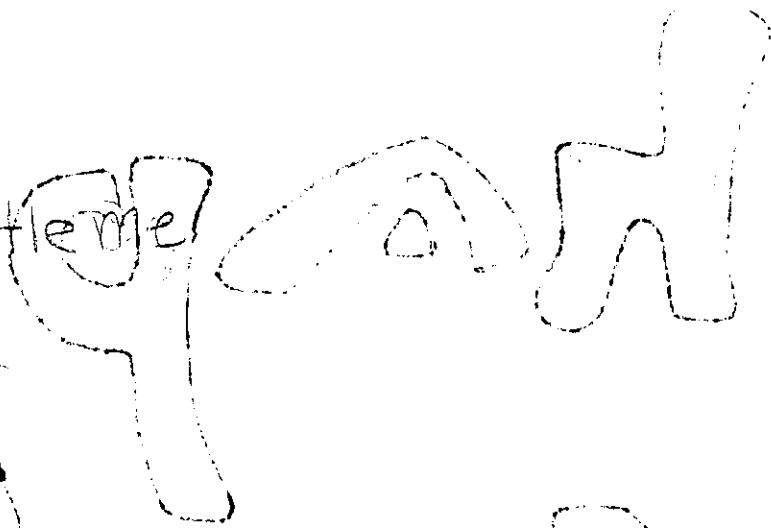

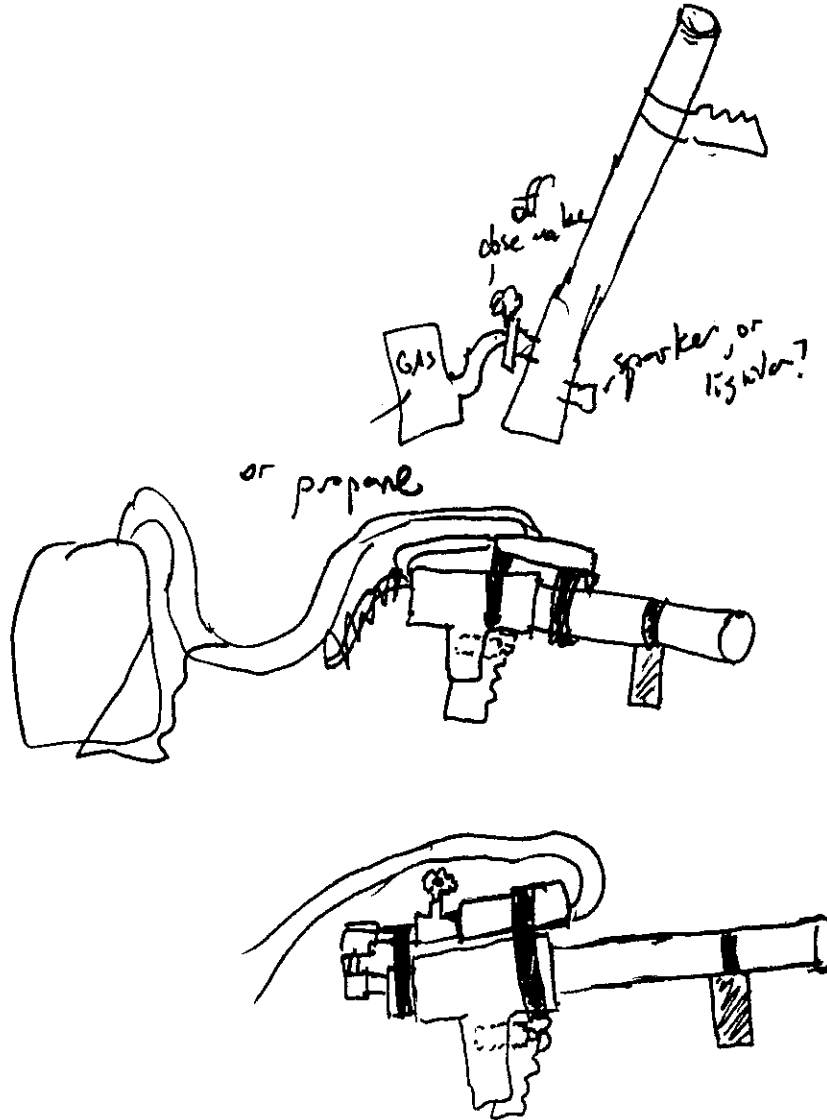

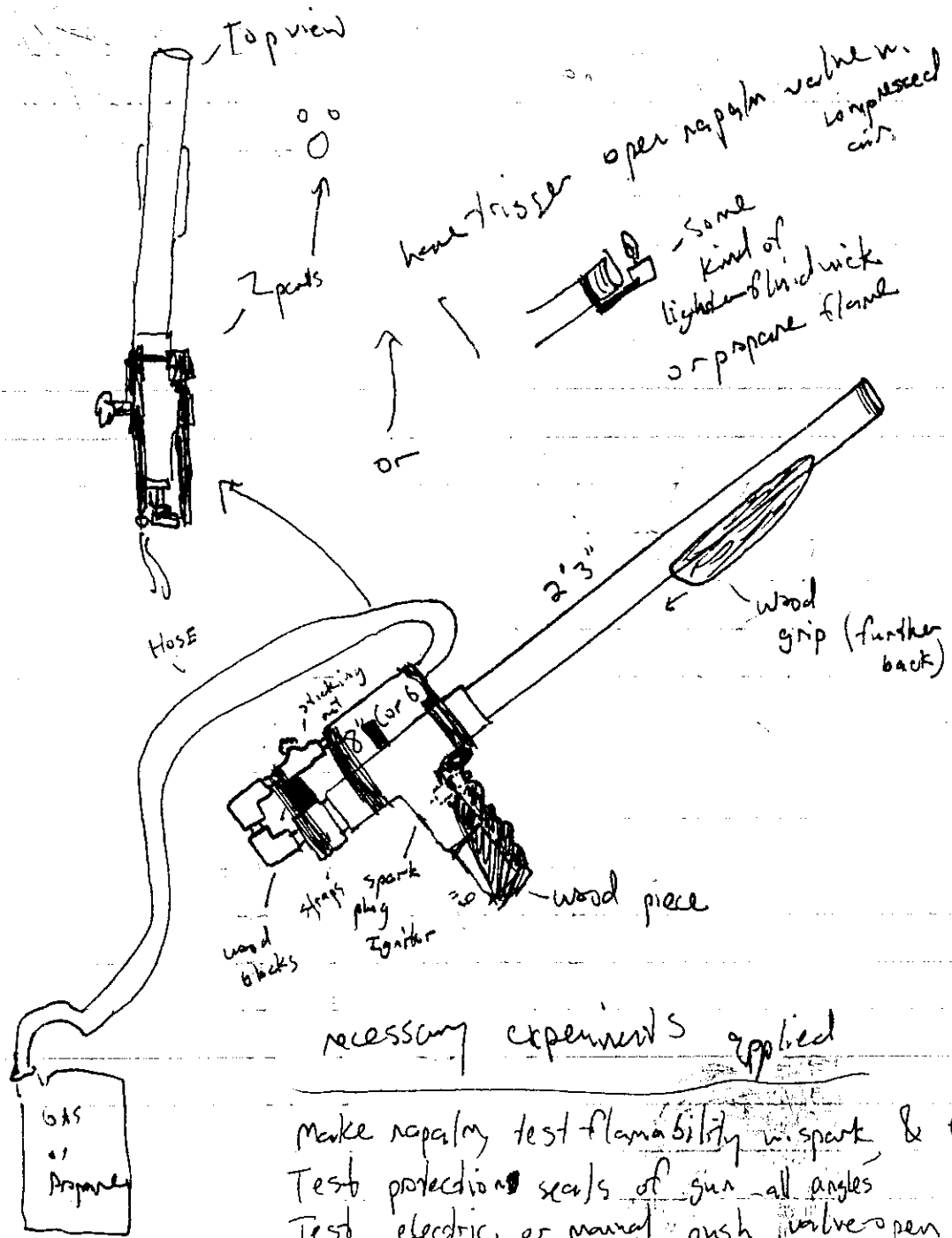

necessary experiments applied

- Make n.p. test flammability w. spark & flame
- Test protection seals of gun all angles
- Test electric or manual push valve open
- Test gasoline w. spark flame
- Engineer mounted flame
- Test duration of burning fuels

best of your serious

navign

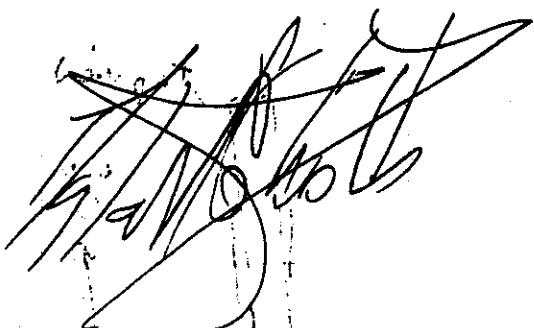

some
to hand
in the
area



medium
hand

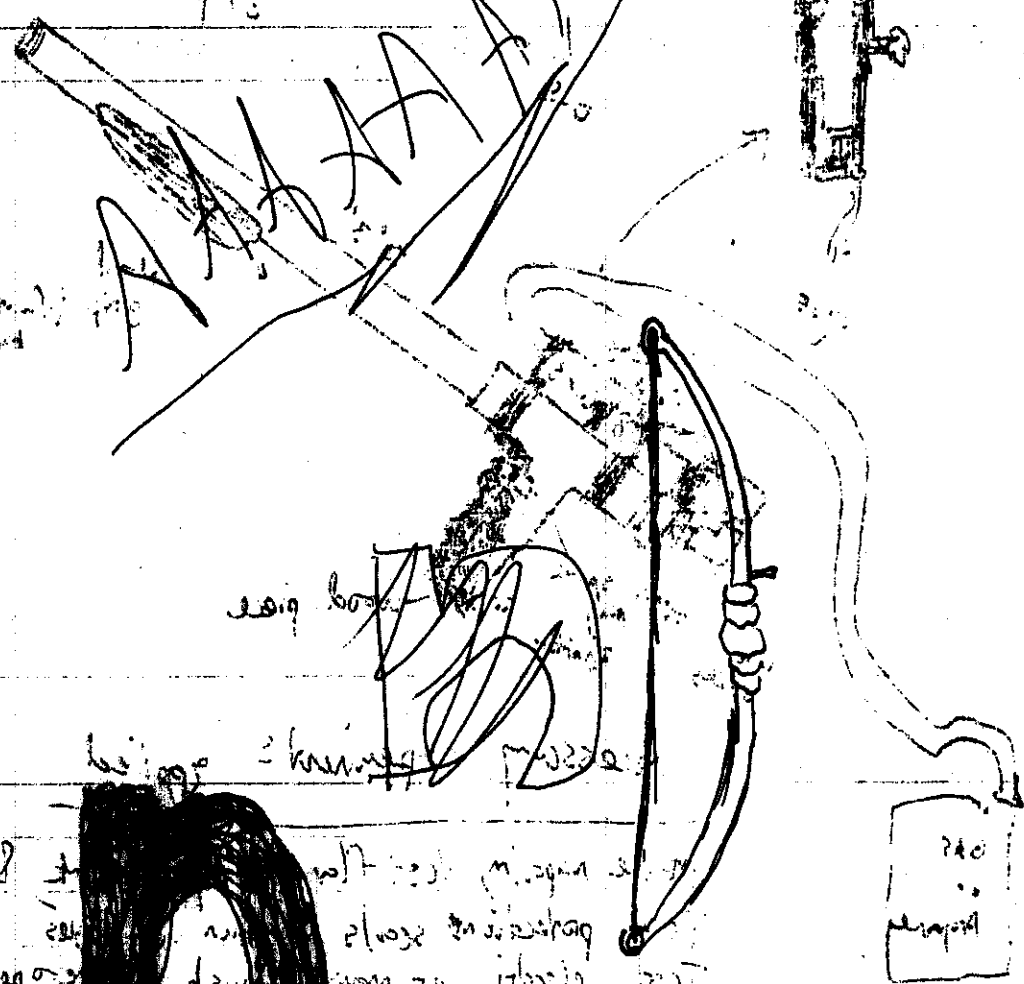

big box

big box = kniv

Jan 7 2 4
est
mag

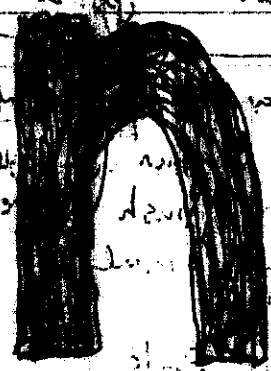

with
place
magn
magn
magn

The **Firearms Coalition** of Colorado

Volume XI Issue 7

Dear Firearms Activist:

The Firearms Coalition of Colorado is working for you!

At the Colorado State Legislature, we have some very good pro-gun bills moving toward passage, and we need your help to put them through.

HB 1305 (Rep. McPherson/Sen. Dennis) is pre-emption by the State of most local gun control ordinances. It has passed the House and is out of Committee in the Senate. It is up for second reading on the Senate floor. We are trying to improve it. Support Sen. Dennis' efforts!

HB 1316 (Rep. Dean/Sen. Chlouber) is the best Right to Carry concealed bill yet. It has everything gun owners want and contains what Gov. Owens has said that he will sign - N.I.C.S. check that will exempt permit holders from Brady background checks, and training (Hunter Safety course will be sufficient).

SB 205 (Sen. Teck/Rep. Clapp) is out of Committee in the Senate and up for second reading on the Senate floor. It prohibits any municipality or the State from suing any firearms manufacturer like the tobacco companies have had to fight.

After you have read this, phone, fax or e-mail your State Senator and Representative and give your support for these bills! Their Phone numbers are on the backs of each flyer. If you do not know the names of your elected officials, call your County Clerk & Recorder and they can tell you.

P.O. Box 1454
Englewood, CO 80150-1454

JC-001-026514

**State Senators
districts, names and
phone numbers are on
the back page**

COLORADO STATE SENATE

Toll Free Number out of Denver Metro Area is 1-888-473-8136

Dist	Senators Name	Capitol Phone	Home/Bus.	Dist	Senators Name	Capitol Phone	Home/Bus
01	Marilyn Musgrave	R 303-866-4877	970-867-3245	19	Jim Congrove	R 303-866-4840	303-940-1919
02	Mark D Hillman	R 303-866-6360	719-346-7689	20	Ed Perlmutter	D 303-866-4856	303-278-8426
03	Bill Thiebaut	D 303-866-4878	719-544-3822	21	Michael F. Feeley	D 303-866-2318	303-987-1354
04	Ken Chlouber	R 303-866-4869	719-486-0008	22	Norma V Anderson	R 303-866-4859	303-986-0397
05	Gigi Dennis	R 303-866-4871	719-547-9330	23	Ken Arnold	R 303-866-4876	303-466-2666
06	Jim Dyer	D 303-866-4884	970-259-1942	24	Alice Nichol	D 303-866-4863	303-287-7742
07	Ronald J Teck	R 303-866-3077	970-243-8947	25	Bob Martinez	D 303-866-4855	303-287-8111
08	Dave Wattenberg	R 303-866-5292	970-723-4577	26	Tom Blickensderfer	R 303-866-3341	303-758-0146
09	Doug Lamborn	R 303-866-4835	719-481-3387	27	John Andrews	R 303-866-4883	303-770-8215
10	Ray Powers	R 303-866-3342	719-596-1055	28	Elsie Lacy	R 303-866-2578	303-750-5943
11	Mary Ellen Epps	R 303-866-6364	719-391-9509	29	Frank Weddig	D 303-866-4879	303-366-8762
12	Mary Ann Tebedo	R 303-866-4880	719-471-2561	30	John Evans	R 303-866-4881	303-840-0252
13	Tony Grampas	R 303-866-4873	303-674-7883	31	Doug Linkhart	D 303-866-4861	303-733-3569
14	Peggy Reeves	D 303-866-4841	970-482-8952	32	Pat Pascoe	D 303-866-4852	303-832-8865
15	Stan Matsunaka	D 303-866-4853	970-663-0896	33	Gloria Travis Tanner	D 303-866-4864	303-355-7288
16	David T Owen	R 303-866-2587	970-330-9600	34	Rob Hernandez	D 303-866-4862	303-458-1011
17	Terry Phillips	D 303-866-5291	303-666-9488	35	Dottie Wham	R 303-866-4875	303-757-0615
18	Dorothy Rupert	D 303-866-4872	303-402-1999				

Mailing Address:
 Colorado State Capitol
 200 East Colfax
 Denver, CO 80203

State of Colorado Home Page
<http://www.state.co.us/>

WHEN YOU CALL OR WRITE, BE POLITE AND RESPECTFUL, WE WANT TO WIN FRIENDS, NOT MAKE ENEMIES

**TO KEEP INFORMED ABOUT FIREARMS LEGISLATION,
 CHECK THE FIREARMS COALITION'S MESSAGE AND INFORMATION CENTER (303) 296 GUNS (296-4867)
 Web Site <http://cssa-co.org/fcc>**

COUPON - SEND TO THE ADDRESS BELOW - MAKE CHECKS PAYABLE TO FIREARMS COALITION OF COLORADO

YES I support the Firearms Coalition of Colorado, Sign me up now. (You can contribute as often as you like)

Individual Membership \$15 per year
 Family Membership \$25 per year
 Sustaining Membership \$50 per year
 Corporate Membership \$250 per year
 Patron \$500 per year
 Legal Defense Fund [\$]

I want to volunteer to help:

Make calls at your Phone Bank Phone Tree
 Distribute Literature, at Gun Shows Door to Door
 Stuff envelopes for mailings Courier

Print Name _____
 Address _____
 City _____ State _____ Zip Code _____ County _____
 Home Phone (with area Code) _____
 Work Phone (with area code) _____
 FAX Phone (with area code) _____
 e-mail _____

The Coalition does influence legislation, so your contribution is not tax deductible, but whoever said the cost of freedom was free?

This flyer was prepared and paid for by:
 The Firearms Coalition of Colorado
 PO BOX 1454 Englewood, CO 80150-1454 e-mail; firearmscoalition@juno.com
 Office (303-308-3006) FAX (303-295-6587) Len Horner Chairman

JC-001-026515

Legislative Alert

Volume XI Issue 5.3

Please make and distribute copies to friends, neighbors, co-workers and relatives.

New Right To Carry bill will carry the day

HOUSE BILL 1316 BEST YET

A new concealed carry bill, HB-1316 Sponsored by Representatives Doug Dean, Brad Young and Jack Taylor plus Senator Ken Chlouber is moving forward.

Sheriffs in, Chiefs out

The Sheriffs will issue the Right to Carry (RTC) permits taking the Police Chiefs out of the picture except for places like Denver where they don't have a Sheriff.

Shall issue

It is a 'shall issue' bill instead of the present 'may' issue. If you can possess a firearm under Federal Law and Colorado State Law, you can get an RTC permit. That means that if you are an honest, stable citizen, you can get an RTC permit. If you are a felon, a fugitive, illegal alien, insane, convicted of domestic violence, etc. forget it. If you have been charged and found not guilty or had the charges dismissed for an offense that would prevent your from owning a firearm, you had better check your record.

Starts in less than 6 months

It will take effect September 1, 1999. If you have a permit issued before July 1, 1999 it is good through June 30, 2000 or to the normal expiration date if it expires prior to July 1, 1999.

Moderate cost every five years

The fee for both the initial permit and renewals are to reflect the actual direct and/or indirect cost. This is not to exceed \$100. The permit will be

good for five years, and will provide privacy from FBI record keeping when you buy a gun.

Age and residency

You must be 21 years old and a legal resident of the state of Colorado. Members of the Armed Forces and members of their immediate family stationed at military installations in Colorado are considered legal residents.

Training

You must furnish a training certificate from a handgun training class, hunter safety course, or a certificate showing honorable discharge from military service that reflects pistol qualifications obtained within five years prior to the date on which the application is issued.

Restrictions on carry

A concealed handgun permit does not authorize any person to carry a concealed handgun into any place where the carrying of firearms is prohibited by federal law.

Circumstances exempt from permit requirements

Any person who may legally possess a handgun may carry a handgun without a permit under the following circumstances; The handgun or a portion of the handgun is sufficiently visible so that a reasonable person is able to determine that it is a handgun, including, but not limited to, a handgun in a holster that is worn outside the clothing. The handgun is in a case, cover, or enclosure designed

specifically for carrying, covering, or protecting the handgun and it is not fastened to the person or clothing of the person carrying the handgun.

The handgun is in the possession of a person who is in a private automobile or some other private means of conveyance and who carries the handgun for any legal use including self defense, or for transportation to and from any other legal activity including but not limited to target shooting or hunting.

HELP PASS RIGHT TO CARRY

If you want to to get Right to Carry (RTC) then you must get active. Phone and/or write your State Representative. Phone numbers are on the back page.

Mailing Address:

Colorado State Capitol
200 East Colfax
Denver, CO 80203

If you don't know what district you are in, look for your county's listings in the blue pages of your phone book. Call your County Clerk to get the number of the districts you live in. You have three districts; (1) U.S. Congress; (2) Colorado State Senate; (3) Colorado State House. You are concerned with item (3).

When you call or write, tell your Representative you support the right of decent law abiding people to carry guns if they so choose. If you get an answering machine, just leave the same message. It only takes a minute.

COLORADO HOUSE OF REPRESENTATIVES

Dist Representative	Pty	Capitol Phone	Home/ Bus.	Dist Representative	Pty	Capitol Phone	Home/Bus.
01 Fran Coleman	D	303-866-2966	303-935-2174	34 Lois Tochtrop	D	303-866-2931	303-469-9217
02 Gloria Leyba	D	303-866-2911	303-623-5676	35 Ann F Ragsdale	D	303-866-2843	303-429-5002
03 Jennifer Veiga	D	303-866-2921	303-722-4940	36 Stephanie Takis	D	303-866-2912	303-343-8303
04 Frana Araujo Mace	D	303-866-2954	303-433-5093	37 Lauri Clapp	R	303-866-5510	303-761-1825
05 Nolbert D Chavez	D	303-866-2925	303-807-5640	38 Joe Stengel	R	303-866-2953	303-798-9857
06 Dan Grossman	D	303-866-2015	303-355-4219	39 Nancy Spence	R	303-866-2935	303-690-5106
07 Benjamin Clarke	D	303-866-2909	303-322-2611	40 Gary L McPherson	R	303-866-2944	303-320-6100
08 Penfield Tate	D	303-866-2959	303-388-0920	41 Suzanne Williams	D	303-866-2919	303-751-2396
09 Ken Gordon	D	303-866-5523	303-753-1383	42 Bob Hagedorn	D	303-866-3911	303-367-1994
10 Dorthy Gotlieb	R	303-866-2910	303-770-1841	43 Debbie Allen	R	303-866-2942	303-695-4920
11 Todd Saliman	D	303-866-2583	303-444-0727	44 Lola Spradley	R	303-866-3540	719-485-3755
12 Bill Swenson	R	303-866-2920	303-776-0846	45 Joyce R Lawrence	R	303-866-2922	719-543-5401
13 Tom Plant	D	303-866-2938	303-258-9575	46 Abel J Tapia	D	303-866-2968	719-544-8036
14 Ron Tupa	D	303-866-2915	303-417-0282	47 Kenneth Kester	R	303-866-2948	719-456-0603
15 Ron May	R	303-866-5525	719-591-8620	48 W H Bill Webster	R	303-866-2943	970-352-3356
16 William D Sinclair	R	303-866-2965	719-635-8691	49 Steve Johnson	R	303-866-2907	970-223-8045
17 Andy McElhany	R	303-866-2904	719-473-9400	50 Tambor Williams	R	303-866-2929	970-352-2780
18 Doug Dean	R	303-866-2348	719-598-4920	51 William G. Kaufman	R	303-866-2947	970-669-4009
19 Richard D Decker	R	303-866-2946	719-390-8312	52 Steve Tool	R	303-866-2581	970-223-9008
20 Lynn Hefley	R	303-866-2924	719-598-2871	53 Bob Bacon	D	303-866-2917	970-221-4552
21 Keith King	R	303-866-2191	719-576-6149	54 Matt Smith	R	303-866-3068	970-434-4727
22 Marcy Morrison	R	303-866-2937	719-685-5929	55 Gayle Berry	R	303-866-2582	970-255-9121
23 Penn R. Pfiffner	R	303-866-2951	303-988-3717	56 Jack Taylor	R	303-866-2949	970-879-1880
24 Maryanne Keller	D	303-866-5522	303-425-0130	57 Russell George	R	303-866-2346	970-625-3778
25 John Witwer	R	303-866-2957	303-679-0773	58 Kay L Alexander	R	303-866-2955	970-249-5862
26 Scott McKay	R	303-866-2923	303-986-6957	59 Mark Larson	R	303-866-2914	970-564-0999
27 Sue Windels	D	303-866-2962	303-421-6405	60 Al Gagliardi	D	303-866-2963	719-589-5259
28 Don Lee	R	303-866-2939	303-933-6295	61 Carl Miller	D	303-866-2952	719-486-0636
29 Marl Paschall	R	303-866-2950	303-609-4500	62 Bryan S Sullivan	R	303-866-2916	970-453-4954
30 Rob Fairbank	R	303-866-2927	303-932-1170	63 Brad Young	R	303-866-2940	719-336-7967
31 Paul Zimmerman	D	303-866-2918	303-457-8464	64 Joe Nunez	R	303-866-2936	303-979-8601
32 Valentin J Vigil	D	303-866-2964	303-457-0667	65 Diane Hoppe	R	303-866-3706	970-522-3237
33 Shawn Mitchell	R	303-866-4667	303-465-5945				

WHEN YOU CALL OR WRITE, BE POLITE AND RESPECTFUL, WE WANT TO WIN FRIENDS, NOT MAKE ENEMIES

**TO KEEP INFORMED ABOUT FIREARMS LEGISLATION,
CHECK THE FIREARMS COALITION'S MESSAGE AND INFORMATION CENTER (303) 296 GUNS (296-4867)
Web Site <http://cssa-co.org/fcc>**

COUPON - SEND TO THE ADDRESS BELOW - MAKE CHECKS PAYABLE TO FIREARMS COALITION OF COLORADO

YES I support the Firearms Coalition of Colorado, Sign me up now. (You can contribute as often as you like)

- Individual Membership \$15 per year
- Family Membership \$25 per year
- Sustaining Membership \$50 per year
- Corporate Membership \$250 per year
- Patron \$500 per year
- Legal Defense Fund [\$]

I want to volunteer to help:

- Make calls at your Phone Bank Phone Tree
- Distribute Literature, at Gun Shows Door to Door
- Stuff envelopes for mailings Courier

Print Name _____

Address _____

City _____ State _____ Zip Code _____ County _____

Home Phone (with area Code) _____

Work Phone (with area code) _____

FAX Phone (with area code) _____

e-mail _____

The Coalition does influence legislation, so your contribution is not tax deductible, but whoever said the cost of freedom was free?

This flyer was prepared and paid for by:
The Firearms Coalition of Colorado
PO BOX 1454 Englewood, CO 80150-1454 e-mail; firearmscoalition@juno.com
Office (303-308-3006) FAX (303-295-6587) Len Horner Chairman

JC-001-026517

Legislative Alert

Volume XI Issue 6

Please make and distribute copies to friends, neighbors, co-workers and relatives.

Bill will stop Denver from stealing your vehicle and your firearm

DENVER ORDINANCE LEGALIZES PIRACY

Denver Ordinance 37-50 allows Denver to seize property because of a firearm. This could be your vehicle, a rental vehicle, a hotel or condo.

If the Denver Authorities find a legal firearm in your possession, they can seize the property. The owner of the property doesn't have to be involved with the firearm. In other words, if you are renting a hotel room or condo, it can be seized. If it is a rental vehicle you will have to pay the car rental company for it. Check with your insurance company. Ask them if Denver seizes your car because you broke a Denver Ordinance, will they pay for it? No they won't since you broke the law. Will the finance company let you off the hook? Again, no. You will still have to pay for the car that Denver is now in possession of. You drive

through Denver on the way to a shooting competition, gun show, hunting, etc., you can lose your car. Even if you have a concealed carry permit, Denver can still confiscate your car.

OFF TO JAIL AS WELL AS LOSE YOUR CAR

So far, we've only discussed the property aspects of this ordinance. What happens to you? You can be arrested and spend time in jail. You get to spend thousands of dollars to defend yourself when you have done nothing more serious than drive through Denver with a firearm in a vehicle.

HOUSE BILL OVERTURNS DENVER'S ORDINANCE

House Bill 1305 prohibits any municipality, county, or city and county from adopting any ordinance or resolution

that would impose a greater restriction on a person's ability to own, possess, carry, use, or transfer a firearm than is imposed by state law. It also identifies imposition of a greater penalty as being a greater restriction. It specifies that any ordinance or resolution in existence as of the effective date of the act that violates the provisions of the act shall be deemed unauthorized and unenforceable. It changes the affirmative defenses to the charge of carrying concealed weapons to exceptions.

Call your State Senator now and tell them to vote for HB-1305

State Senators districts, names and phone numbers are on the back page

COLORADO STATE SENATE

Toll Free Number out of Denver Metro Area is 1-888-473-8136

Dist	Senators Name	Capitol Phone	Home/Bus.	Dist	Senators Name	Capitol Phone	Home/Bus
01	Marilyn Musgrave	R 303-866-4877	970-867-3245	19	Jim Congrove	R 303-866-4840	303-940-1919
02	Mark D Hillman	R 303-866-6360	719-346-7689	20	Ed Perlmutter	D 303-866-4856	303-278-8426
03	Bill Thiebaut	D 303-866-4878	719-544-3822	21	Michael F. Feeley	D 303-866-2318	303-987-1354
04	Ken Chlouber	R 303-866-4869	719-486-0008	22	Norma V Anderson	R 303-866-4859	303-986-0397
05	Gigi Dennis	R 303-866-4871	719-547-9330	23	Ken Arnold	R 303-866-4876	303-466-2666
06	Jim Dyer	D 303-866-4884	970-259-1942	24	Alice Nichol	D 303-866-4863	303-287-7742
07	Ronald J Teck	R 303-866-3077	970-243-8947	25	Bob Martinez	D 303-866-4855	303-287-8111
08	Dave Wattenberg	R 303-866-5292	970-723-4577	26	Tom Blickensderfer	R 303-866-3341	303-758-0146
09	Doug Lamborn	R 303-866-4835	719-481-3387	27	John Andrews	R 303-866-4883	303-770-8215
10	Ray Powers	R 303-866-3342	719-596-1055	28	Elsie Lacy	R 303-866-2578	303-750-5943
11	Mary Ellen Epps	R 303-866-6364	719-391-9509	29	Frank Weddig	D 303-866-4879	303-366-8762
12	Mary Ann Tebedo	R 303-866-4880	719-471-2561	30	John Evans	R 303-866-4881	303-840-0252
13	Tony Grampas	R 303-866-4873	303-674-7883	31	Doug Linkhart	D 303-866-4861	303-733-3569
14	Peggy Reeves	D 303-866-4841	970-482-8952	32	Pat Pascoe	D 303-866-4852	303-832-8865
15	Stan Matsunaka	D 303-866-4853	970-663-0896	33	Gloria Travis Tanner	D 303-866-4864	303-355-7288
16	David T Owen	R 303-866-2587	970-330-9600	34	Rob Hernandez	D 303-866-4862	303-458-1011
17	Terry Phillips	D 303-866-5291	303-666-9488	35	Dottie Wham	R 303-866-4875	303-757-0615
18	Dorothy Rupert	D 303-866-4872	303-402-1999				

Mailing Address:
 Colorado State Capitol
 200 East Colfax
 Denver, CO 80203

State of Colorado Home Page
<http://www.state.co.us/>

WHEN YOU CALL OR WRITE, BE POLITE AND RESPECTFUL, WE WANT TO WIN FRIENDS, NOT MAKE ENEMIES

**TO KEEP INFORMED ABOUT FIREARMS LEGISLATION,
 CHECK THE FIREARMS COALITION'S MESSAGE AND INFORMATION CENTER (303) 296 GUNS (296-4867)
 Web Site <http://cssa-co.org/fcc>**

COUPON - SEND TO THE ADDRESS BELOW - MAKE CHECKS PAYABLE TO FIREARMS COALITION OF COLORADO

YES I support the Firearms Coalition of Colorado, Sign me up now. (You can contribute as often as you like)

- Individual Membership \$15 per year
- Family Membership \$25 per year
- Sustaining Membership \$50 per year
- Corporate Membership \$250 per year
- Patron \$500 per year
- Legal Defense Fund [\$]

I want to volunteer to help:

- Make calls at your Phone Bank Phone Tree
- Distribute Literature, at Gun Shows Door to Door
- Stuff envelopes for mailings Courier

Print Name _____

Address _____

City _____ State _____ Zip Code _____ County _____

Home Phone (with area code) _____

Work Phone (with area code) _____

FAX Phone (with area code) _____

e-mail _____

The Coalition does influence legislation, so your contribution is not tax deductible, but whoever said the cost of freedom was free?

This flyer was prepared and paid for by:

The Firearms Coalition of Colorado
 PO BOX 1454 Englewood, CO 80150-1454 e-mail; firearmscoalition@juno.com
 Office (303-308-3006) FAX (303-295-6587) Len Horner Chairman

JC-001-026519

F

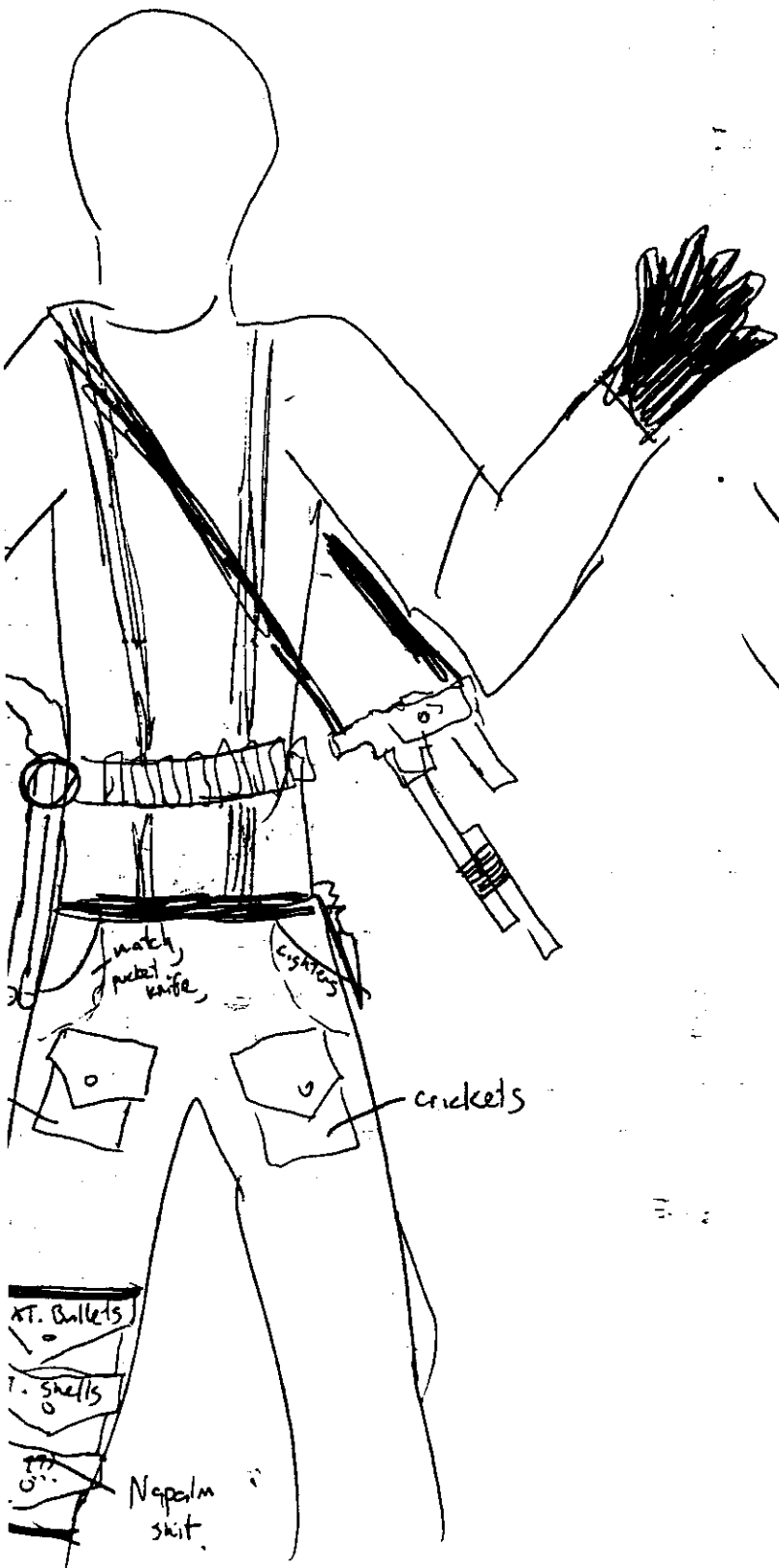

B

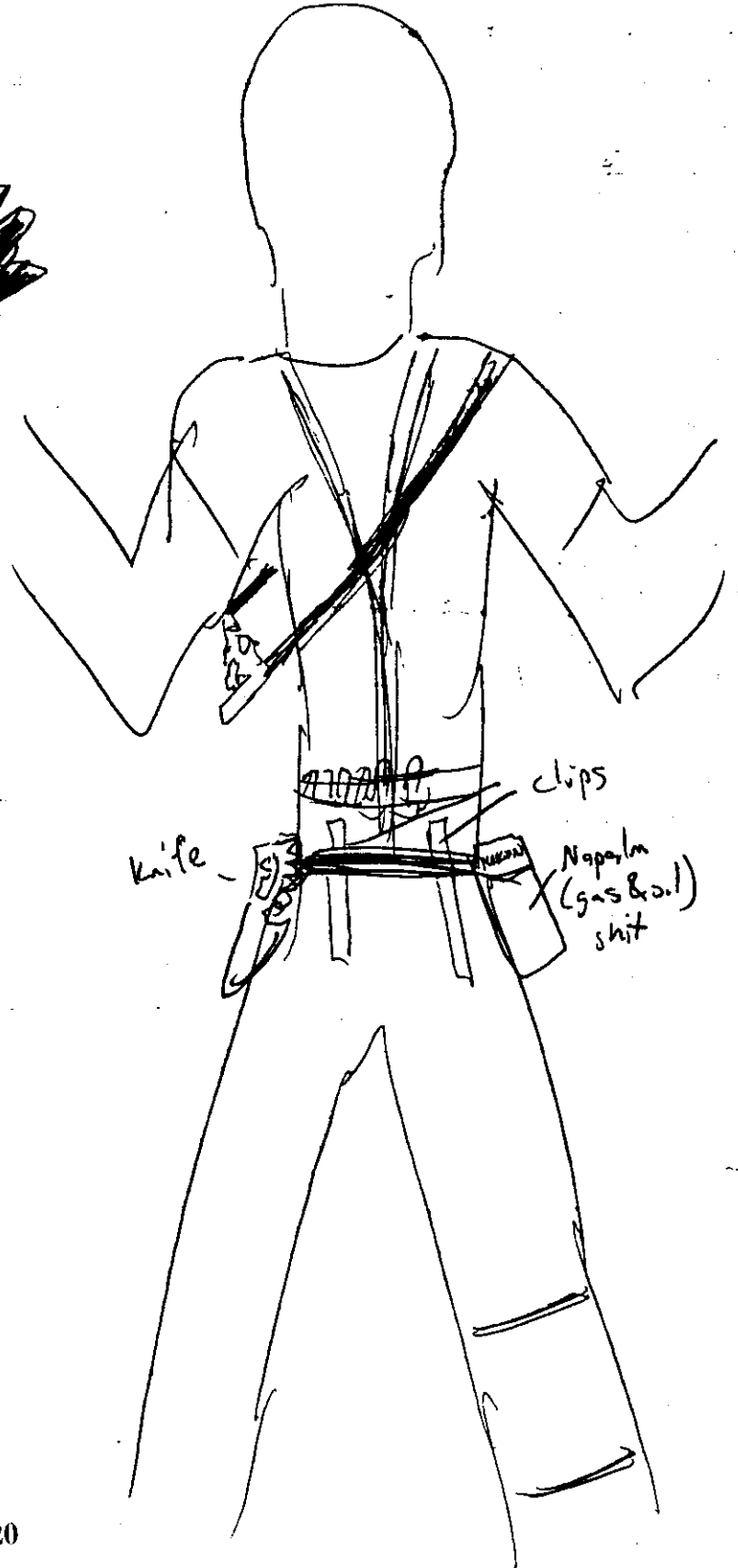

DO 3 HIT FOR NRK

- File off clip.
- Buy suspenders.
- Buy cargo pants
- work out carrying gear plan
- Find out how to carry TEC-9
- Get pouches - geologist in yer old closet.
- Get napalm containers
- Buy straps
- Figure out how to carry knife
- Practice in-car gearups
- Get bullets
- Get shells - .00
- Give Reb powder
- Buy Adidas soccer bag(s)
- Give Reb glass containers
- Fill up gas cans
- Find volatile combo. of gas & oil
- Look for vintage amplifier, Enthead or RadioShack
- Buy "wraith" T-shirt
- Buy punk gloves.

B Day shirt

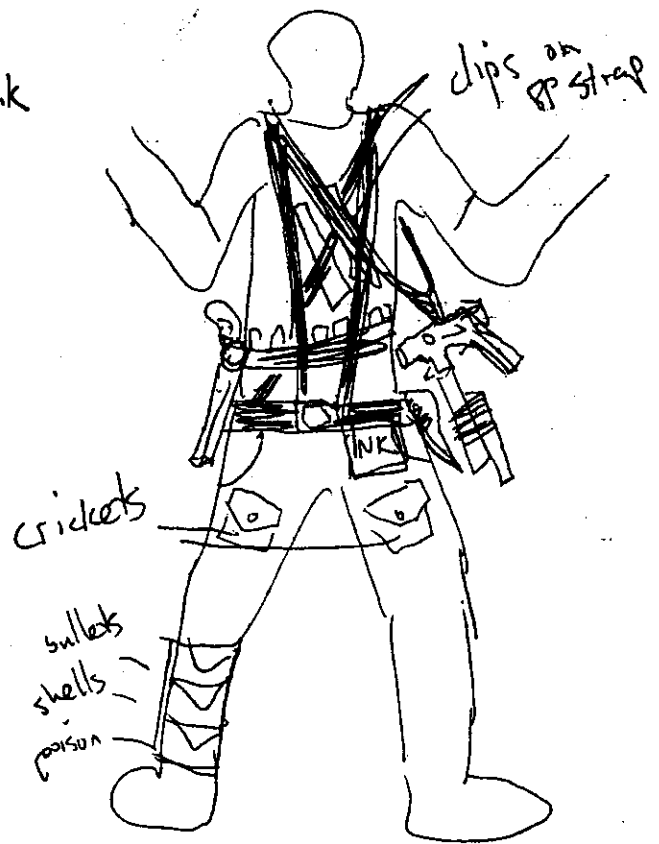

#6013

Dylan Klebold
2-?-99
LA, 4
To make this more readable, double space
use King, and consider a larger font. This is difficult to edit!

great opening

The town, even at 1:00 AM, was still bustling with activity as the man dressed in black walked down the empty streets. The moon was barely visible, hiding under a shield of clouds, adding a chill to the atmosphere. What was most recognized about the man was the sound of his footsteps. Behind the conversations & noises of the town, not a sound was to be heard from him, except the dark, monotonous footsteps, combined with the jingling of his belt chains striking not only the two visible guns, in their holsters, but the large bowie knife, slung in anticipation of use. The wide-brimmed hat cast a pitch-black shadow of his already dimly lit face. He wore black gloves, with a type of metal spiked-band across the knuckles. A black overcoat covered most of his body, small lines of metal & half-inch spikes layering upper portions of the shoulders, arms, and back. His boots were newly polished, and didn't look like they had been used much. He carried a black duffel bag in his right hand. He apparently had parked a car nearby, & looked ready for a small war with whoever came across his way. I have never seen anyone take this mad-max approach in the city, especially since the piggies had been called to this part of town for a series of crimes lately. Yet, in the midst of the nightlife in the center of the average-sized town, this man walked, fueled by some untold purpose, what Christians would call evil. The guns slung on his belt & belly appeared to be automatic hand guns, which were draped above rows of magazines & clips. He smoked a thin cigar, and a sweet clovesque scent emanated from his aura. He stood about six feet and four inches and was strongly built. His face was entirely in shadow, yet even though I was unable to see his expressions, I could feel his anger, cutting thru the air like a razor. He seemed to know where he was walking, and he noticed my presence, but paid no attention as he kept walking toward a popular bar, The Watering Hole. He stopped about 30 feet from the door, and waited. "For whom?" I wondered, as I saw them step out. He must have known their habits well, as they appeared less than a minute after he stopped walking. A group of college-preps, about nine of them, stopped in their tracks. A couple of them were mildly drunk, the rest sober. They stopped, and stared. The streetlights illuminating the bar & the sidewalk showed me a clear view of their stare, full of paralysis & fear. They knew who he was, & why he was there. The second-largest spoke up "What're you doin man.... why are you here...?" The man in black said nothing, but even at my distance, I could feel his anger growing. "You still wanted a fight huh? I meant not with weapons, I just meant a fist fight.... cmon put the guns away, fuckin pussy!" said the largest prep, his voice quavering as he spoke these works of attempted courage. Other preps could be heard muttering in the background; "Nice trench coat dude, that's pretty cool there...." "Dude we were jus messin around the other day chill out man... " ... "I didn't do anything, it was all them!!" ... "cmon man you wouldn't shoot us, were in the middle of a public place..." Yet, the comment I remember the most was uttered from the smallest of the group, obviously a cocky, power hungry prick. "Go ahead man! Shoot me!!! I want you to shoot me!! Heheh you wont! Goddam pussy..." It was faint at first, but grew in intensity and power as I heard the man laugh. This laugh would have made Satan cringe in Hell. For almost half a minute this laugh, spawned from the most powerful place conceivable, filled the air, and thru the entire town, the entire world. The town activity came to a stop, and all attention was now drawn to this man. One of the preps began to slowly move back. Before I could see a reaction from the preps, the man had dropped his duffel bag, and pulled out one of the pistols with his left hand. Three shots were fired. Three shots hit the largest prep in the head. The shining of the streetlights caused a visible reflection off of the droplets of blood as they flew away from the skull. The blood splatters showered the preps buddies, as they were to paralyzed to run. The next four preps were not executed so systematically, but with more rage from the man's hand cannon than a controlled duty for a soldier. The man unloaded one of the pistols across the fronts of these four innocents, their instantly lifeless bodies dropping with remarkable speed. The shots from that gun were felt just as much as they were heard. He pulled out his other pistol, and without changing a glance, without moving his death-stare from the four other victims to go, aimed the weapon out to the side, and shot about 8 rounds. These bullets mowed down what, after he was dead, I made out to be an undercover cop with his gun slung. He then emptied the clip into two more of the preps. Then, instead of reloading & finishing the task, he set down the guns, and pulled out the knife. The blade loomed huge, even in his large grip. I now noticed that one of two still alive was the smallest of the band, who had now wet his pants, and was hyperventilating in fear. The other one tried to lunge at the man, hoping that his football tackling skills would save his life. The man sidestepped, and made two lunging slashes at him. I saw a small trickle of blood cascade out of his belly and splashing onto the concrete. His head wound was almost as bad, as the shadow formed by the bar's lighting showed blood dripping off his face. The last one, the smallest one, tried to run. The man quickly reloaded, and shot him thru the lower leg. He instantly fell, and cried in pain. The man then pulled out of the duffel bag what looked to be some type of electronic device. I saw him tweak the dials, and press a button. I heard a faint, yet powerful

ou?

rework

Mad Max

through

It

great details

well done

Please make this !!!

notice how stopped commenting

explosion, I would have to guess about 6 miles away. Then another one occurred closer. After recalling the night many times, I finally understood that these were diversions, to attract the cops. The last prep was bawling & trying to crawl away. The man walked up behind him. I remember the sound of the impact well. The man came down with his left hand, right on the prep's head. The metal piece did its work, as I saw his hand get buried about 2 inches into the guy's skull. The man pulled his arm out, and stood, unmoving, for about a minute. The town was utterly still, except for the faint wail of police sirens. The man picked up the bag and his clips, and proceeded to walk back the way he came. I was still, as he came my way again. He stopped, and gave me a look I will never forget. If I could face an emotion of god, it would have looked like the man. I not only saw in his face, but also felt emanating from him power, complacency, closure, and godliness. The man smiled, and in that instant, thru no endeavor of my own, I understood his actions.

Quite
Daw
andine

Wylan

Am offended by
your use of profanity.
In class we
had discussed the
approach of using
1 # !

Also - I'd like to talk to
you about your story
before I give
you a grade. You are an
excellent writer/storyteller,
but I have some problems
with this one.

44-7625
 COPY OF DOC'S FROM BMW
 4-26-99/1642
 ITEM # 6014

ORIGINAL

THE EXPIRATION DATE LISTED HEREON APPLIES ONLY IF THE PREMIUM HAS BEEN PAID.

EVIDENCE OF INSURANCE - STATE OF COLORADO

Policy Number [REDACTED] Year 81 Make BMW 320i
 Vehicle I.D. No. [REDACTED]
 Effective Date SEP. 03, 98 Expiration Date APR. 04, 99

25-2021 4-88 12961 C4000

FARMERS INSURANCE EXCHANGE

Colorado Insurer, in compliance with the Colorado Compulsory Insurance Law effective January 1, 1982, certifies that it has issued a policy of motor vehicle Liability and Personal Injury Protection Insurance (Motor Vehicle Liability for motorcycles) in an amount not less than that required by the Colorado Financial Responsibility Law for the described motor vehicle.

AGENT 20 377
 RONALD E SABEL
 PHONE 303 933-1100

THOMAS E KLEBOLD
 [REDACTED]
 LITTLETON CO 80127-5115



KEEP THIS CERTIFICATE IN YOUR AUTOMOBILE AT ALL TIMES
 READ REVERSE SIDE CAREFULLY

CBZ 2636

DR2574(04/98)
 COLORADO REGISTRATION/OWNERSHIP TAX RECEIPT

TYPE	PLATE	TABVAL	VIN	EXPIRE				
PER-FEE	[REDACTED]	PMT# 1	[REDACTED]	02091999				
TITLE	YR.	MAKE	BODY	SERIES	MODEL	CWT/PASS	T/C	FLEET#
	1982	BMW	CP					
PUR. DATE	PUR. PRICE	ORIGINAL TAXABLE VALUE	BUS. DATE	CO.#	U/R CODE			
12/26/1998	0.00		01/19/1999	11	R999			
PREV. EXP.	PRIOR O.T.	OWN. TAX	LIC. FEE	TITLE FEE	OTHER FEE			
			2.00					
RTD TAX	COUNTY TAX	CITY TAX	STATE TAX	SPECIAL FEE	FUEL			
0.00	0.00	0.00	0.00	0.00				
UNIT#	GVW	MILES	HIGVW	HC DATE				

MOTOR VEHICLE INSURANCE IS COMPULSORY IN COLORADO, NON-COMPLIANCE IS A MISDEMEANOR TRAFFIC OFFENSE.
 OWNER NAME/MAILING ADDRESS
 KLEBOLD THOMAS E
 KLEBOLD SUSAN Y
 [REDACTED]
 LITTLETON CO 80127
 ONLY PERMIT ISSUED TO OBTAIN EMISSION.
 NW/EMS/11D174157/CK

VALIDATION PAID JEFFERSON 28 01/19/1999 0810295TA TOTAL 2.00

Apology

Dear Mr. Ricky Becker,

Hello, my name is Eric Harris. On a Friday night in late-January my friend and I broke into your utility van and stole several items while it was parked at Deer Creek Canyon Road and Wadsworth. I am writing this letter partly because I have been ordered to from my diversion officer, but mostly because I strongly feel I owe you an apology and explanation.

I believe that you felt a great deal of anger and disappointment when you learned of our act. Anger because someone you did not know was in your car and rummaging through your personal belongings. Disappointment because you thought your car would have been safe at the parking lot where it was and it wasn't. If it was my car that was broken into, I would have felt extreme anger, frustration, and a sense of invasion. I would have felt uneasy driving in my car again knowing that someone else was in it without my permission. I am truly sorry for that.

The reason why I chose to do such a stupid thing is that I did not think. I did not realize the consequences of such a crime, and I let the stupid side of me take over. Maybe I thought I wouldn't be caught, or that I could get away. I realized very soon afterwards what I had done and how utterly stupid it was. At home, my parents and everyone else that knew me was shocked that I did something like that. My parents lost almost all their trust in me and I was grounded for two months. Besides that I have lost many of my privileges and freedom that I enjoyed before this happened. I am now enrolled in the diversion program for one full year. I have 45 hours of community service to complete and several courses and classes to attend over the course of my enrollment.

Once again I would like to say that I am truly sorry for what I have done and for any inconvenience I have caused you, your family, or your company.

Respectfully,

Eric Harris

JC-001-026525

anger management

The anger management class I took was helpful in many ways. I feel the instructors were well qualified for this class and the class size was not too big. I learned several things about how drugs and alcohol contribute to violence, and how to avoid using drugs and alcohol. I felt like the class was focused more on people who had committed violent crimes and people who use drugs and alcohol, rather than being more broad. Nevertheless I still learned what anger is, how to recognize it, and how to deal with it. Violence is expensive, along with anger. Committing violent crimes brings forth fees, bills, and punishment that have very deep affects on that person, not to mention the emotional turmoil it causes. I learned the four stages of anger; tension building, verbal escalation, physical escalation, and opportunity for change. I believe the most valuable part of this class was thinking up ideas for ways to control anger and for ways to release stress in a non-violent manner. Things such as writing, taking a walk, talking, lifting weights, listening to different music, and exercising are all good ways to vent anger. We also discussed the positive and negative results of anger and violence. Another thing we discussed was "triggers." Triggers are defined as warnings or symptoms that one experiences when getting angry. Things like quick breathing, tunnel vision, muscles tighten, and teeth clench. I feel that all of the suggestions can all be helpful, but the main part of anger management comes from the individual. If the person does not want to control his/her anger, then it can be a problem. The person must want to control his/her anger and actually want to not be violent or angry. It all starts in the person's mind. I have learned that thousands of suggestions are worthless if you still believe in violence. I am happy to say that with the help in this class, and several other diversion-related experiences, I do want to try to control my anger.

Nazism was a form of government unlike any other in history. Led by Adolf Hitler, the Nazis had distinct beliefs and policies, severe racism and hatred, strong, new family values, and plans for future Germany and the world. The Nazi party came to power in the early 1930s, thanks to Adolf Hitler. Hitler was loved and admired by all of his followers. The Nazis derived many symbols from ancient runes and made code names for things like their concentration camps. They also formed several new laws and restrictions. Racist beliefs and violent actions were all part of everyday life in Nazi Germany. Concentration camps killed millions of people using gas chambers and firing squads. The Jewish race was considered inferior, and therefore extremely and harshly discriminated against by law. Family values were encouraged, education was reformed, the women's roles were outlined, the Aryan race was to be the only race, and law controlled breeding. Education was reformed in order to benefit the state, not the individual. The woman's main role was to bear children, cook, and clean. The Aryan race was the only "superior" race, so therefore Hitler wanted Germany to have all Aryan citizens. Only the elite would reproduce and inferior races were restricted from breeding with the superior race. Hitler had several plans for his new Germany, and for the world as well. Hitler wanted leaders in Germany. He also wanted to control what everyone saw and heard to maintain a working state. The youth of the world was to be under Nazi control, and Europe and Russia were to be conquered. Approximately eleven million people died as a result of the Nazis. The Nazis were one of the most racist forms of government ever.

The Nazi Culture

Thesis: Nazism was a form of government unlike any other in history, with their beliefs and policies, their racism and hatred, their very strong family values, and the plans they had in store for the rest of the world.

- I. The Nazis
 - A. How they came to power
 - 1. Hitler
 - 2. Love for Hitler
 - 3. Energy
 - B. Who they were
 - 1. Runes
 - 2. Code words
 - C. Policies
 - 1. Censorship
 - 2. Control
 - 3. Euthanasia
 - 4. Aliens
- II. Racism and violence
 - A. Concentration camps
 - 1. Doctors and wives
 - 2. Shootings
 - 3. Gas chambers
 - 4. Reinforcement of hatred
 - B. Jews
 - 1. Insults and racist comments
 - 2. Inferior race

- III. Family values
 - A. Education
 - 1. What education would benefit
 - 2. Textbooks
 - 3. Science in racism
 - B. Women
 - 1. Children
 - 2. Discrimination
 - C. Aryan race
 - 1. Mental
 - 2. Physical
 - D. Breeding
 - 1. Only the elite would reproduce
 - 2. Jews as inferiors
- IV. Future Plans
 - A. Europe
 - 1. Leaders
 - 2. Freedoms
 - 3. Censorship of the nation
 - B. World
 - 1. Youth
 - 2. Russia
 - 3. Space

To Kill A Mockingbird 5 PARAGRAPH ESSAY

To Kill A Mockingbird is a classic novel by Harper Lee filled with real, interesting and well developed characters. In the story, Jem is a young boy with a sister Scout and his father, Atticus. Jem is the character that changed the most in this story, and he was one of the most important and well developed characters. The dynamic character of Jem Finch will be discussed in terms of his description in the beginning of the story, what events or people changed him during the story, and his description in the end of the story.

Jem Finch will be described in his physical description, his personality characteristics, and his relationship between other characters. Jem is about ten years old at the start of the story. "When I was almost six and Jem was nearly ten."(Lee 10-11). This quote means that Jem is four years older than his sister, Scout. He also was a skinny boy. "He went out for football, but was so slender and so young yet to do anything but carry the teams water bottles."(Lee 244). During the beginning of the story Jem is very polite. "Dill blushed and Jem told me to hush."(Lee 12). This means that Jem didn't want to embarrass Dill and he didn't want Scout asking questions like that, he thought it wasn't right. Jem was also a caring brother, he always had Scout with him. "That summer Dill came to us."(Lee 11). US, it is always us or we whenever Scout is talking. Jem and Scout were more than just brother and sister, they were best friends. "Our teacher says Miss Caroline's introducing a new way of teaching."(Lee 22-23). That sentence shows that Jem also cares about Scout's school problems and not just family problems. Jem and Dill grew closer every day as friends. "They spent days together in the tree house, plotting and planning, calling me only when they needed a third party."(Lee 46). This means that during the summer Jem and Dill spent more time together than with Scout, showing that they were becoming good friends.

During the middle and end of the story Jem changed in many ways. He got more mature, he understood the different ways folks acted and he took on more responsibility. He took on more responsibility by reading to Mrs. Dubose on her death bed. "This change in Jem had come about in a matter of weeks, Mrs. Dubose was not cold in her grave."(Lee 117). This statement shows that reading to her and her death made him realize more about adults and how to act like them. When the big court trial against Tom Robinson came Jem was extremely interested in it. He was curious about why people would accuse another man for something he didn't do. "Hush, Jem said, Mr. Heck Tate's testifyin'."(Lee 168). This quote showed that he was becoming older and acting more mature by being interested in the case. When Aunt Alexandria moved in he comforted Scout whenever she was yelled at by her. He just went into her room and cheered her up. This showed that Jem really cared about Scout and that he was maturing.

At the end of the story Jem had a major change in his physical appearance, he also had relational and attitudinal changes. On Halloween night Mr. Ewell tried to kill Jem and Scout but Jem stopped him long enough for Scout to get a head start. Then Mr.

Ewell broke Jem's arm and knocked him out, but Boo Radley saved them. "He's got a bump on his head just like yours, and a broken arm"(Lee 267). This showed that he had broke his arm and was knocked out while trying to save Scout. One relational change is that as Jem grew older he didn't want Scout around him much, because he had other friends. So their friendship grew slightly apart. Last an attitudinal change that Jem had was that at the beginning of the story he thought Boo Radley was some mean psychotic cat and squirrel eater that never came out of his house. But at the end of the story he realized that Boo was a caring man that was just afraid of all the racism in the world so he stayed inside during the day.

The dynamic character of Jem Finch was discussed in terms of a description in the beginning of the story, what people or events changed him during the story, and a description at the end of the story. Jem Finch was changed at the end of the story because of Aunt Alexandria moving in, Because of Reading to Mrs. Dubose, and because of the trail against Tom Robinson. He matured and took on a lot of responsibility in this story. In conclusion, Jem Finch changed a lot during this story, physically and mentally. But what he really did was he just grew up.

A recent article in the Rocky Mountain News talked about how an "entire generation is on trial." Bill Clinton and Monica Lewinsky, Kenneth Starr, Susan McDougal, and several powerful leaders in the past were all mentioned. The author talked about how the public does not understand the society in which it lives. He talked about how the public is manipulated and brainwashed into having bogus opinions about others in the news. "How come the public has a more negative view of Monica Lewinsky than Bill Clinton? It takes two to tango so why is Monica more to blame than Bill?" is one view he had. He also explained how people in the past such as Hitler and Evita got the power and love of their people by hardly doing anything to deserve it. The author suggests interviewing an interviewer whose integrity is respected and whose style is to bring out what the guest has to say, rather than impose his own agenda on the discussion. He believes that if the public still doesn't understand issues after seeing both sides of the story, then we should be giving up hope.

I agree with this author. I believe he has several very interesting points and comments. The public can indeed be misled to believe things that it would normally find "wrong" or "immoral." I believe that more and more people in this day and age are becoming, or at least think they are becoming, less attentive and caring less about media and politics. More people think they "don't care" about things like the Lewinsky story or about O.J. Simpson or stories like those, but they still watch the news reports on them, and they still buy articles and magazines that contradict what they say. Not everyone is like that, so I am not saying everyone is a hypocrite. However, I think that if the news reports and magazine articles keep filling people's minds with certain points of views, then eventually those people will start to think that way, as the author of the above article mentioned.

The article I chose to review this week is an article on daytime napping. The author reviewed a book on the art of napping. It is suggested that a 15 to 20 minute nap during the early afternoon can be beneficial. Any more could be considered as sleep inertia. Creativity and problem-solving skills can be regained by taking a short nap. One professor says that approximately eight hours after you awake you can experience a large drop in alertness. The author reviewed one company who decided to incorporate a nap-room into their daily routine. Employees can sign-up for naps during the day and not have to worry about getting in trouble with their boss.

Personally I agree with the author and the professor mentioned above. About eight hours after I wake up I get very sleepy and I become less and less alert. That, although, is on an average, uneventful day. Now I am not saying that Columbine should throw in a few "nap-hours" around lunchtime, but it might not hurt. Going to bed earlier could help too, but I believe it's harder to go to bed earlier than it is to take a nap later. Some people may say we are just lazy, and they might be right, but if we are lazy and not hurting anyone then what is the loss? If I have two hours to get a job done and I can finish it in one, why not sleep? It can be brought down into an ethical/moral question and argued out even more, but I think if you want to sleep, go ahead. Just don't get in the way.

article 3

Eric Harris
Period 2
9/25/98

The article I reviewed this week was an editorial from a local newspaper. The author discussed how Americans are open to talk about almost anything, except death. He says that 81% of Americans have not talked with their doctors about the medical issues of dying. Also, patients that are terminally ill are reluctant to talk about death with their family members and their families are even reluctant to carry out their final wishes. Very few Americans take advantage of federal laws that allow them to determine the nature of the care they will get in their dying hours.

My response to this article is that I think that more Americans need to discuss death with their families and with their doctors. It is a fact of life, and it seems in this day and age people talk about just about anything they can think up. From sexual situations to violence on the streets to alien encounters, we talk about it all. So why not death? Perhaps with today's technology we receive a false sense of security in the fact that we think we could die the next day. With medical technology and thousands of safety procedures in today's society, I believe that the majority of the people think, "oh I'll talk about death some other time, it's not like I'll be dying soon." It may be a hard topic, but oh well, it definitely needs to be discussed incase of the terrible event that a loved one slips into a coma or something of that nature.

JC-001-026534

article 4.

This week's article was on a bill recently rejected in Erie, Indiana. The bill was to have every homeowner in the town to own a firearm, and to have it in working condition in his/her household. The bill was rejected and was considered too dangerous.

Arguments were that in cities with the strictest gun laws, gun crimes were the highest. So therefor, if gun laws were diminished in severity, and homeowners had guns, the crime rate would go down.

My response to this article is that I think in theory the bill was a good idea. Having a gun in every house would most definitely decrease crime. However, since not every homeowner is all that responsible, intelligent, and wise, other problems would arise. Children playing with loaded weapons and getting hurt, normal household disputes are solved with gunfire, accidental shootings would rise and rise. I believe that it is a law of nature that not everything can work smoothly and turn out the way it was supposed to. While crimes like burglaries and robberies would go down, shootings would most likely skyrocket. So therefor I think it was a good idea to reject this bill.

article 5

My article review this week is about an article in which the author describes how dropping bombs and missiles are cowardly, indiscriminate, and a little short of terrorism. The author used a scene from Saving Private Ryan in which an American fighter plane bombs a tank right in front of Tom Hanks. The author said that even with today's weapons that is hard to do. He also describes how the public feels about bombs and missiles. He says that the public likes "clean" air campaigns and watching the little TV video of a building blowing up in the desert. His basic point was that the bombers and fighters in the air was and is not the only way to win, that it still counts on the soldiers on the ground.

My response to this article is that I think this person has never really paid much attention to how violence and wars work. In regards to his first comment, that scene in Saving Private Ryan where the tank is destroyed is most definitely possible and happened many times over the course of the war, that's why the planes were called "tank busters." Who ever said launching missiles was courageous? I know I sure didn't and I believe our generals didn't either. It is simply a much better way to solve problems and to eliminate installations than sending in an entire battalion. Of course wars still rely on the ground troops, but air support is definitely a part of winning the war. The author says, "How noble is a cause worthy only of having your bombs thrown into it, and not your sons?" Sending your sons off to fight and die for your country is one thing, but the simple act of pushing a button is another. Usually, if bombs and cruise missiles can't stop the enemy, then we send in the ground troops. Of course a fighter plane isn't enough, but neither is the ground force.

JC-001-026536

article 4

Eric Harris
Period 2
11/5/98

The article I chose to review this week is on drivers not moving for emergency vehicles. The article mentioned how emergency response teams have trouble with motorists getting out of their way when going to or coming from a scene of an accident or emergency. Motorists many times just slam on their brakes in the middle of the road, cause other accidents trying to get out of the way, or don't even know there is a emergency vehicle coming because the radio is too loud or they are on a cell-phone. Recently an ambulance was sideswiped by a motorist who didn't even see/hear it coming, the ambulance was carrying a victim of an earlier accident to a hospital, and a second ambulance was called to the scene because of the motorist's careless driving.

My response to this article is that I think it is completely ridiculous that motorists risk the lives of others that are in desperate need of medical attention because of their arrogance. I have seen people who refuse to move out of the way when a fire truck is trying to get by, with lights and sirens on. Some people think they are so important and their destination is of the utmost priority and that nothing better get in their way. Even if 10 children are burning to death or if an elderly man is having a heart attack, that motorist absolutely must get to the grocery store or to the movie theater. Some people don't even know that they are supposed to get out of the way of emergency vehicles when their lights are on and the siren is flashing. Actually, it is the law. One can get a "failure to yield" ticket and possibly loose points on their license for not getting out of the way. It is not a personal choice one makes to get out of the way, it is the law, and yet people still think, "oh they can go around me," or "hey I have the right-of-way here, even if your lights and sirens are on!"

JC-001-026537

My last article is on the new Brady bill. The Brady bill that went into affect recently requires all licensed gun deals to have instant background checks from the FBI when selling a firearm of any kind. In theory this was a good idea. This would keep guns out of the hands of people who have felony charges on their police record, dishonorable discharge from the military and illegal immigrants. The background checks will take anywhere from thirty minutes to a few days.

The FBI just shot themselves in the foot. There are a few loopholes in the new Brady bill. The biggest gaping hole is that the background checks are only required for licensed dealers...not private dealers. The number of licensed dealers dropped from 5,011 in 1993 to 1,715 in 1998. Private dealers can sell shotguns and rifles to anyone who is 18 or older, and they can sell handguns to anyone who is 21 or older, without background checks of any kind. Another problem with the bill is that misdemeanor crimes of abuse and violence do not show up, and sometimes police and mental health records aren't put into the FBI's database. Only about 50% of the needed information is there. Therefore 50% of the criminals who want guns have a pretty good chance of getting them from a licensed dealer.

DEFENSE ATTORNEY EDWARD J. REILLY

During the Lindbergh kidnapping trial, the defendants' (Bruno Hauptman) lawyer was Edward J. Reilly. Reilly did a terrible job in defending Bruno Hauptman. Reilly just sat in his seat, drunk with his dentures in his pocket and sometimes napping, not objecting to anything said by the prosecuting attorney David Wilentz. Reilly did not even object to the kidnap ladder showed in court. The kidnap ladder was made out of poor quality wood, but Hauptman was a carpenter. Also, the ladder was poorly built, and Hauptman was a carpenter. Also, the work records were doctored, to show that Hauptman didn't work the day of the meeting in the cemetery. And that he quit the day the ransom money was paid. Another objection that should have been made was that on the inside of a closet in Hauptmans' house was the phone number of John F. Condon, the go-between in the kidnapping. But the writing wasn't made by Hauptman, it was made by a reporter after Hauptman was captured. The police knew about this but didn't say anything, instead the phone number was used in the trial against Hauptman. So in conclusion, Bruno Hauptman would have probably been found innocent if Edward Reilly would have been more active in the trial, and objected more.

John Knowles published a novel entitled A Separate Peace. This story takes place in a high school in New England. The book has been set during World War II. The students are almost at drafting age. War is an ever present topic among the students of the high school called Devon. John Knowles displays the theme of war in writing a Separate Peace.

During the course of the book, war is usually the topic of many conversations and thoughts. One such topic comes after a student named Leper enlists for the army, and then returns home because he is afraid of the army. "For if Leper was psycho it was the army which had done it to him." (135-136). "And the perfect word for me, psycho. I guess I am. I must be. Am I, though, or is it the army?" (141-142). Once Leper received his discharge from the army, many of the students talked about his mental state for a while. Another topic of the war is that one student, Finny, is always denying that World War II is even real. "Don't be a sap, there isn't any War." (107). "The fat old men who don't want us crowding them out of their jobs. They've made it all up." (107). Finny denies the war constantly. Finny and his best friend Gene are the two main characters in the book. Many times they talk about the war or about the effects of war. "When we did talk it was about aviation training programs and brothers in the service." (89). "How many rails did you sabotage today, Quakenbush?" (90). This has a large effect on the students of Devon High School.

World War II, being the main theme in this book, usually has an influence on the students of Devon High. Student Preparation for the war is another important part in this book. "They were off somewhere shaping up for the war." (27-28). "I think it's time we started to get a little exercise around here, don't you?" (28). Thoughts are often towards

the men in the battlefield. "Not forgetting that troops were being shuttled toward battlefields all over the world." (109). "At least as easy as it was to imagine an American force crawling through the jungles of a place called Guadalcanal." (110). While the students are at school, a few recruiters come by to teach the students about the army. "A recruiter from the United States ski troops showed a film to the senior class in the Renaissance Room." (115). "I'm going to enlist in the ski troops." (117). The recruiters cause a couple of students to enlist.

Beside the war between the United States and Nazi Germany and Imperial Japan, there is a war between the students. One such conflict is between Gene and Finny. Gene, at one time, disliked Finny very much and thought Finny was trying to destroy his academic goals. "Finny had put him up to it, to finish me good on the exam." (66). "I should have told him then that he was my best friend also and rounded off what he said. I started to, I nearly did. But something held me back. Perhaps I was stopped by that level of feeling deeper than thought, which contains the truth." (40). Gene and Leper have many disputes between themselves. "You stupid crazy bastard." (137). "You make me sick, you and your damn army words." (136). These wars tend to resort in violence rather than peace. After the initial war between Gene and Finny, Gene defends Finny because Gene accidentally broke Finny's leg. Gene defends him in a serious sort of manner, too. "I hit him hard across the face." (71). "Finny isn't out of it." (149). The war between the students is probably the most important conflict in the book.

While writing A Separate Peace, John Knowles displays the theme of war. During the book, the students of Devon High School talk about World War II constantly. World War II is often the subject and topic of many conversations. The actual war has an

influence on all the students. Even though it is not the most commonly used subject. The most important part of the war theme is the war between the students. These conflicts make this book very interesting. A Separate Peace is a great novel explaining the time during World War II in a New England high school.

Eric Harris
Sphere
Michael Crichton
371 pages

BOOK REPORT

Sphere, by Michael Crichton, is about a team of scientists in the Pacific Ocean. They were in an underwater naval habitat investigating a top secret discovery. The top secret discovery was an extremely large spaceship from an unknown origin. After discovering that the space ship was an American craft, they entered it and found a large sphere 30 feet in diameter. Later, one of the scientists entered the sphere and after he came out he was able to create his thoughts into actual objects. One problem was that the scientist did not know that he had this power.

In the novel, Sphere, I learned many different views on time travel, space, and time itself. I learned that gravity curves space and time. Also, I learned that a black hole in space can make tears in the fabric of time, allowing time travel. Another thing I learned is that under stressful and dangerous conditions many people may turn on one another in order to survive. I liked many things about this novel. One of such was the complete originality of the story line and plot. I also enjoyed how Michael Crichton kept the story going. All throughout the book the story stayed alive and never had any boring or dull parts. The main thing I would have improved about this novel was the origin of the spaceship and the sphere. I wish that Michael Crichton would have told me more about the background of the spaceship and how the sphere got on the ship.

Eric Harris
The Lost World
Michael Crichton
Number of pages, 393

BOOK REPORT

In The Lost World, the sequel to Jurassic Park, a team of scientists discovers an island inhabited by genetically engineered dinosaurs. However, when the scientists try to study the dinosaurs' habits and life styles, the dinosaurs attack. As a result, several people are killed.

In this book, I learned many different ideas for the theory of evolution, such as the theory that all life was created by an alien life form. I Also learned about a theory that all life is meant to become extinct sometime. Another theory I learned is that you can not study a habitat without having an effect on it. The best parts of The Lost World were when the author used his writing skills to tell me the description of a scene. Michael Crichton's use of adjectives and verbs completely put the scene into my mind and in implicit detail. The only thing I believe the author could have done to make the book better was to have a more conclusive ending. The ending leaves you hanging and wondering what happens to the dinosaurs. So, unless the author is preparing the reader for another sequel, the ending could have been improved.

Carrow

The values of Doc

By

Eric Harris

period 1

Mrs. Caruthers

3/13/97

Doc was one of the main characters in John Steinbeck's novel, Cannery Row.

Doc had many characteristics and values. Never having any *animosity* toward anyone or being *wastrel*, Doc maintained his reputation throughout most of the book. He was a kind, *suave* man and he was very forgiving to all people, he never *deviated* from anyone. Doc symbolized the good character in the book because he was forgiving and never held a grudge for more than a few minutes.

Doc was kind for many reasons. He never hurt any animals or any of his specimens for that matter. He would always try to avoid fights or *reprehensible* acts. Often using facts to *discern* the truth, he could settle *contentious* arguments by using his listening and reasoning skills. Everyone in town liked him, because they had no reason to dislike him. Doc never did any harm to anyone or by mission of action, allow anyone to be harmed. Noone ever hated or dissliked Doc because of these characteristics. He symbolized the best parts of a person, and how everyone else should treat each other.

Doc was a very forgiving man in Cannery Row. An example of this is when Mac and the boys *disheveled* his lab. Although the majority of his equipment and specimens were destroyed, he was only mad for a little while then he forgave the boys and cleaned up the mess. This was another reason Doc was loved all around town. People could trust him, and he would never get annoyed or angry with anyone. He symbolized the best parts of human nature, dispite what anyone else did.

In the famous novel by John Steinbeck, Cannery Row, Doc showed a great deal of kindness and love towards others. He showed this by never holding a grudge, by always listening to people, and by treating people the best way he could. Without showing *rancor* toward anyone, Doc symbolized the best parts of all characters. Also, he symbolized what all people should try to be like, and the way everyone should treat one another. Doc was a kind and forgiving man.

Renaissance Essence

In the play Cyrano de Bergerac, written by Edmond Rostand, Cyrano displays a true renaissance essence. He displays a knowledge of poetry, words, feelings, a superb fighting and fencing talent, and extreme generosity. I myself display a variety of mental and physical skills that could classify me as a “renaissance” man. I am efficient in several sports, in writing, in speaking, and in thinking.

In sports, I have been known to play soccer, baseball, football, and even mountain biking. In the sport of soccer, I have played as an offensive and defensive player. These two positions are very different from each other, since offensive is attacking and defensive is defending. I have proven myself to be a superb player in both positions. As for baseball, I was an excellent outfielder and excellent second baseman. These positions are very different from each other and I show a bit of the renaissance essence in the fact that I was good at both of the positions. Playing football and mountain biking are two very different sports from each other and from soccer and baseball. Being able to play them both with a bit of talent shows that I have some renaissance spirit in me.

In the field of writing I have been known to display several different writing techniques. Such as harsh, kind, gibberish, serious, dramatic, and several other kinds. I have written harsh and kind letters to friends. In later response they have said the letters were effective. I have been known to write and even speak plenty of gibberish and meaningless sayings. Serious and often dramatic essays and speeches have come from me, some speeches have even been inspiring. My

writing and speaking techniques have varied day by day and essay by essay, so one could say that I have a bit of the renaissance spirit in me.

My thoughts are the most original and distinctive part of my character. The variety and degree of my thoughts makes me a definite renaissance man. Thinking of topics from love to hate, from anger to enthusiasm, and sorrow to joy. Thoughts are such a unique aspect of one's character that one can not really describe them in a short essay. However, I believe that everyone has a little bit of the renaissance spirit in them just from their thoughts alone.

Sacrifice

In the play Cyrano de Bergerac, Cyrano made many honorable and brave sacrifices. Such as when he gave up all of his money so the people in the theater would be happy or when he spent every day crossing enemy lines just to send a letter to Roxane, his secret lover. I myself can recall one such brave and valiant sacrifice I made in my lifetime. It was when I rode my bike across a one mile trail and back to get my friend out of trouble.

My friend Kris and I were riding our bikes across a dirt trail in a wooded area in upstate New York. We were about a mile into the woods when we found a large drainage pipe. We decided to go explore inside and about 5 minutes into it we ran into a wave of water that knocked us out of the pipe. I landed in a pond below and got a large cut on my right thigh but Kris was caught in some fishing wire right outside the tunnel. After about ten minutes of tugging and pulling we decided that I should go and get a knife to cut the wire since Kris was so entangled in it. So I got onto my bike and peddled through the forest with one leg since my other leg was in too much pain from the cut. I made it to a boat house and found a fishing knife and returned to Kris. He was beginning to get worried about his situation because the water kept getting colder. Even though he was only in about a foot of it. I cut him loose and we both went back to his house and tended to our wounds. The cut on my leg was bigger than I first thought it was, I ended up needing 13 stitches and was left with a very impressive scar. Throughout my whole bike ride to get the knife and return I was in constant pain and agony. My entire leg was covered with blood and dirt and washing it off in the pond's water only hurt more because the pond did not exactly have pure clean uncontaminated water. This was my sacrifice. To save my friend in spite of my pain. I very well could have stayed and spent another half an hour untangling my

friend, but his arm was starting to turn blue since his arm's blood circulation was cut off and I did not think we had time to waste. Plus our parents wanted us back home soon, so we needed to hurry for that reason too. Kris thanked me and was shocked that I did all that for him in spite of my painful wound. That is my most noble sacrifice that I can remember.

Poems and Song Lyrics

"SON OF A GUN"

[REDACTED]

© 1996 KMFDM ENT. US PUBL.

This song, by the German techno-music group "KMFDM," is one of my most favorite songs. This song shows the way I feel about myself sometimes and it also gives me energy and adrenaline so I play this song before my soccer games and such. I have heard this song at many

memorable points in my teenage life, so it therefor comes to mind on many occasions. That is why this song means a lot to me.

"WASTE"

[REDACTED]

© 1996 KMFDM ENT. US PUBL.

This song is not as important to me as the previous, but I still like it for its meaning.

Some of it's lyrics are true to me, but some are not. I believe that these lyrics have a significant amount of meaning to them, so that is why I choose to include this song. It is one of my favorite songs, and I can remember many times when I have actually listened to this song instead of just "hearing" it and thought, "This does have some meaning to it." As opposed to just "hearing" a song, "listening" is when one understands and thinks about the lyrics, or at least, that is my point of view.

JC-001-026554

"STRAY BULLET"

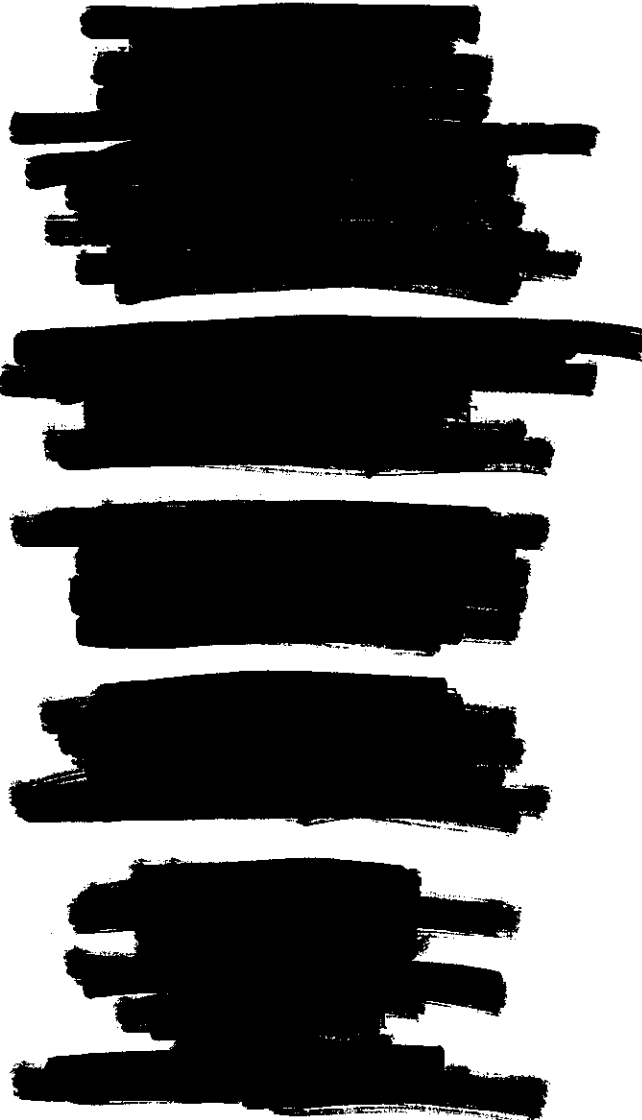

© 1996 KMFDM ENT. US PUBL.

I believe that this song describes my actions and thoughts the best. I have often been described by my friends and even family as a "stray bullet." Jokingly, some people have said that I am a "juggernaut, dearest friend, worst enemy, anarchist" and several other sayings from this song. That is why I chose to include this song, because it has several things in common with me and my personality.

Quotes From the Play

"Why, yesterday I did not have so many friends!"

"I have told her, and she loves you."

"It seems too logical, I have missed everything, even my death!"

"The blood was his."

"And you gentlemen, remember now, no rescue, let me fight alone."

--Each quote is from Cyrano, each font symbolizes the feelings--

Understanding the Play: *Cyrano's tragic flaw*

In Edmond Rostand's play Cyrano de Bergerac, Cyrano has many talents and marvels. He is a poet, a fighter, a lover, a hater, a man of honor, and a man of secrecy. However, he does have one tragic flaw. In the play Cyrano has a rather enormous nose, and he is well aware of this. He loses his temper at anyone who attempts to laugh or make fun of his nose. He thinks that no one could ever love him for his looks and often insults himself about his own looks. He knows he is a great poet and can make women love him for his words, but when it comes to his physical appearance he hides in the shadows and behind others. When it came to his true love Roxane, he uses Christian and his good looks to write what he has always wanted to write to Roxane, and confess his love. But, through Christian he did all of this. So throughout almost the entire play Roxane believes that Christian is the man of her dreams since she receives such beautifully written letters and poems thought to be from Christian. In reality they are from Cyrano. Cyrano is afraid to admit his love to Roxane because he fears that his nose will lead to his downfall with her. Ironically, it did. But rather than Roxane loving only a man who has good looks and a superb writing mind, she falls in love with the soul of a man with such great writing and speaking skills that she had loved so much. Which was Cyrano. Cyrano was only able to confess his love to Roxane when he is about to die. Cyrano's beliefs of his nose and physical appearance being repulsive led to his downfall by only letting him confess his love to Roxane minutes before his death.

What grade I deserve: B+

I feel that I deserve a B plus on the assignment for a few reasons. One of which is the amount of time and effort I spent on my cover sheet and picture. I feel that one could not have more of a renaissance theme than that picture. I have filled all of the requirements except my last paper is about half of a page short. Grammatical and mechanical errors are things that I feel I could have corrected even more if I had spent more time on that part of the assignment. However, most of my time was spent in the cover picture and the first two papers along with the appearance of the total project. That is why I feel I deserve a B plus or a solid B on this paper.

Eric Harris

Understanding the Play: *Cyrano's tragic flaw*

In Edmond Rostand's play Cyrano de Bergerac, Cyrano has many talents and marvels. He is a poet, a fighter, a lover, a hater, a man of honor, and a man of secrecy. However, he does have one tragic flaw. In the play Cyrano has a rather enormous nose, and he is well aware of this. He loses his temper at anyone who attempts to laugh or make fun of his nose. He thinks that no one could ever love him for his looks and often insults himself about his own looks. He knows he is a great poet and can make women love him for his words, but when it comes to his physical appearance he hides in the shadows and behind others. When it came to his true love Roxane, he uses Christian and his good looks to write what he has always wanted to write to Roxane, and confess his love. But, through Christian he did all of this. So throughout almost the entire play Roxane believes that Christian is the man of her dreams since she receives such beautifully written letters and poems thought to be from Christian. In reality they are from Cyrano. Cyrano is afraid to admit his love to Roxane because he fears that his nose will lead to his downfall with her. Ironically,

it did. But rather than Roxane loving only a man who has good looks and a superb writing mind, she falls in love with the soul of a man with such great writing and speaking skills that she had loved so much. Which was Cyrano. Cyrano was only able to confess his love to Roxane when he is about to die. Cyrano's beliefs of his nose and physical appearance being repulsive led to his downfall by only letting him confess his love to Roxane minutes before his death.

C B grade

What grade I deserve: B+

I feel that I deserve a B plus on the assignment for a few reasons. One of which is the amount of time and effort I spent on my cover sheet and picture. I feel that one could not have more of a renaissance theme than that picture. I have filled all of the requirements except my last paper is about half of a page short. Grammatical and mechanical errors are things that I feel I could have corrected even more if I had spent more time on that part of the assignment. However, most of my time was spent in the cover picture and the first two papers along with the appearance of the total project. That is why I feel I deserve a B plus or a solid B on this paper.

Eric Harris

eBlyrx

Poems and Song Lyrics

"SON OF A GUN"

[REDACTED]

© 1996 KMFDM ENT. US PUBL.

This song, by the German techno-music group "KMFDM," is one of my most favorite songs. This song shows the way I feel about myself sometimes and it also gives me energy and adrenaline so I play this song before my soccer games and such. I have heard this song at many

JC-001-026562

memorable points in my teenage life, so it therefor comes to mind on many occasions. That is why this song means a lot to me.

WASTE

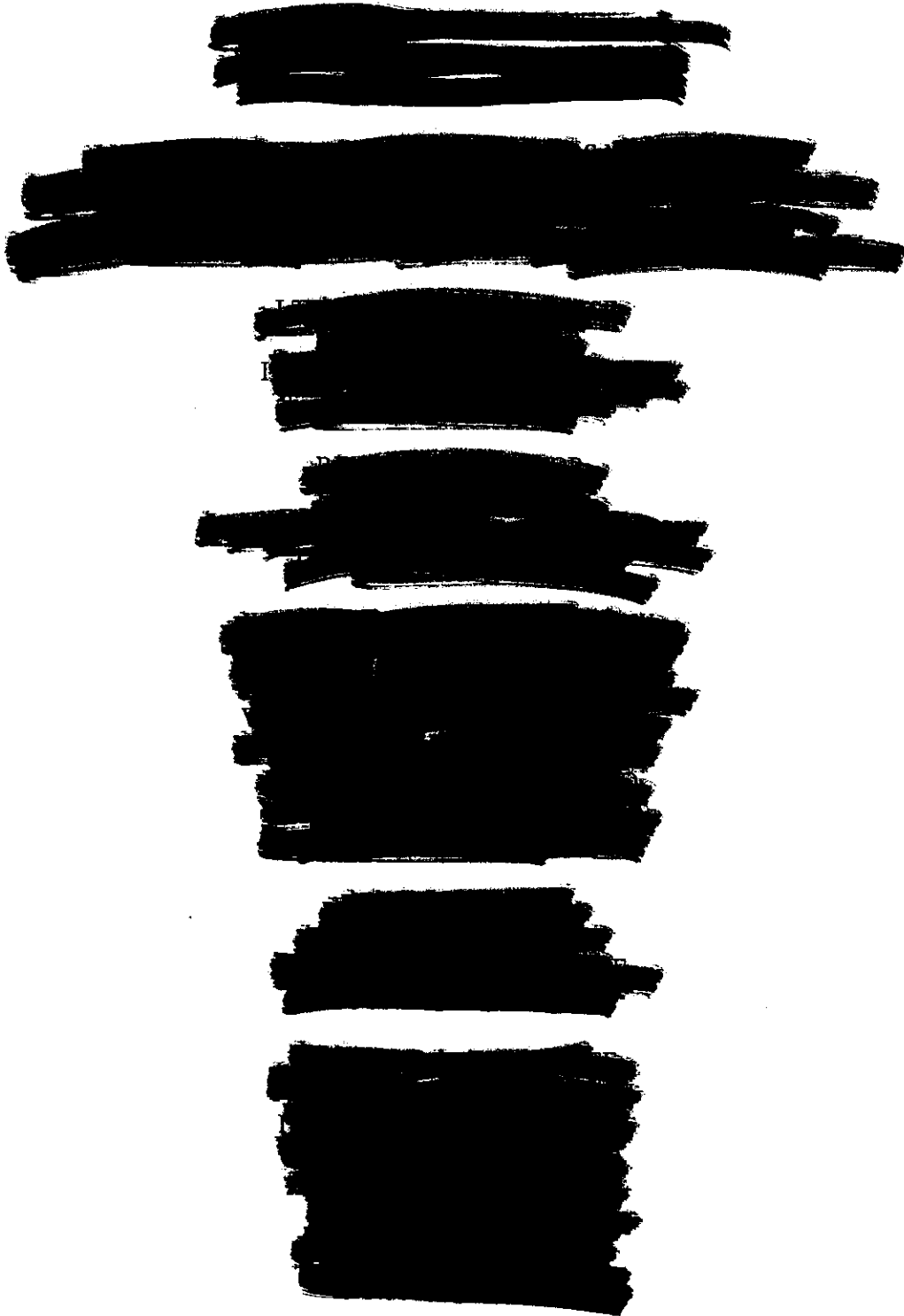

© 1996 KMFDM ENT. US PUBL.

This song is not as important to me as the previous, but I still like it for its meaning. Some of it's lyrics are true to me, but some are not. I believe that these lyrics have a significant amount of meaning to them, so that is why I choose to include this song. It is one of my favorite songs, and I can remember many times when I have actually listened to this song instead of just "hearing" it and thought, "This does have some meaning to it." As opposed to just "hearing" a song, "listening" is when one understands and thinks about the lyrics, or at least, that is my point of view.

JC-001-026564

STRAY BULLET

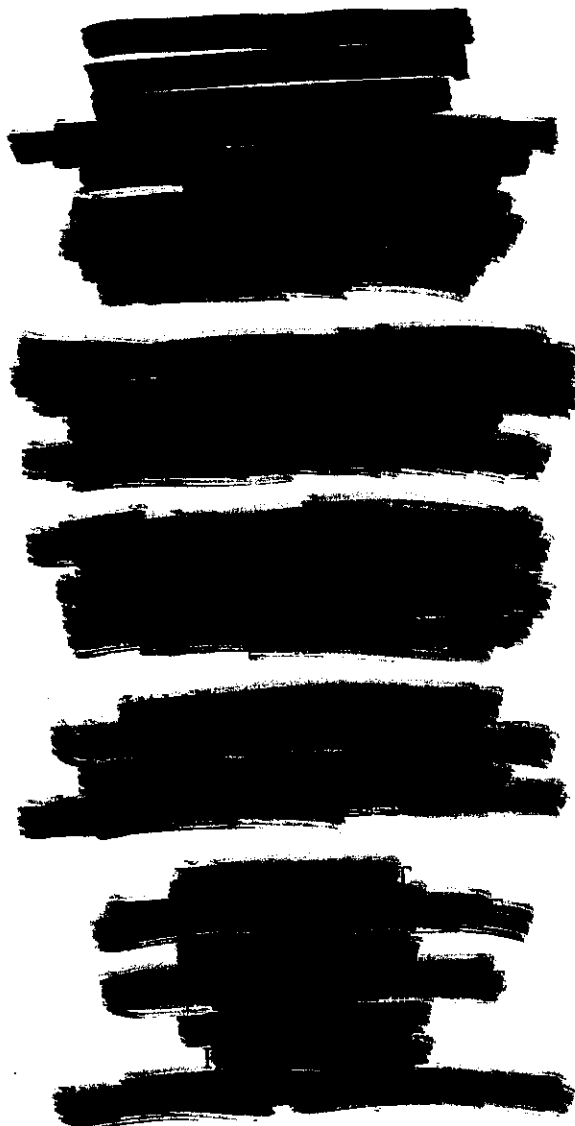

© 1996 KMFD ENT. US PUBL.

I believe that this song describes my actions and thoughts the best. I have often been described by my friends and even family as a "stray bullet." Jokingly, some people have said that I am a "juggernaut, dearest friend, worst enemy, anarchist" and several other sayings from this song. That is why I chose to include this song, because it has several things in common with me and my personality.

CB quotes

Quotes From the Play

"Why, yesterday I did not have so many friends!"

"I have told her, and she loves you."

"It seems too logical, I have missed everything, even my death!"

"The blood was his."

"And you gentlemen, remember now, no rescue, let me fight alone."

--Each quote is from Cyrano, each font symbolizes the feelings--

Renaissance Essence

In the play Cyrano de Bergerac, written by Edmond Rostand, Cyrano displays a true renaissance essence. He displays a knowledge of poetry, words, feelings, a superb fighting and fencing talent, and extreme generosity. I myself display a variety of mental and physical skills that could classify me as a "renaissance" man. I am efficient in several sports, in writing, in speaking, and in thinking.

In sports, I have been known to play soccer, baseball, football, and even mountain biking. In the sport of soccer, I have played as an offensive and defensive player. These two positions are very different from each other, since offensive is attacking and defensive is defending. I have proven myself to be a superb player in both positions. As for baseball, I was an excellent outfielder and excellent second baseman. These positions are very different from each other and I show a bit of the renaissance essence in the fact that I was good at both of the positions. Playing football and mountain biking are two very different sports from each other and from soccer and baseball. Being able to play them both with a bit of talent shows that I have some renaissance spirit in me.

In the field of writing I have been known to display several different writing techniques. Such as harsh, kind, gibberish, serious, dramatic, and several other kinds. I have written harsh and kind letters to friends. In later response they have said the letters were effective. I have been know to write and even speak plenty of gibberish and meaningless sayings. Serious and often dramatic essays and speeches have come from me, some speeches have even been inspiring. My

writing and speaking techniques have varied day by day and essay by essay, so one could say that I have a bit of the renaissance spirit in me.

My thoughts are the most original and distinctive part of my character. The variety and degree of my thoughts makes me a definite renaissance man. Thinking of topics from love to hate, from anger to enthusiasm, and sorrow to joy. Thoughts are such a unique aspect of one's character that one can not really describe them in a short essay. However, I believe that everyone has a little bit of the renaissance spirit in them just from their thoughts alone.

Sacrifice

In the play Cyrano de Bergerac, Cyrano made many honorable and brave sacrifices. Such as when he gave up all of his money so the poepl in the theater would be happy or when he spent every day crossing enemy lines just to send a letter to Roxane, his secret lover. I myself can recall one such brave and valiant sacrifice I made in my lifetime. It was when I rode my bike across a one mile trail and back to get my friend out of trouble.

My friend Kris and I were riding our bikes across a dirt trail in a wooded area in upstate New York. We were about a mile into the woods when we found a large drainage pipe. We decided to go explore inside and about 5 minutes into it we ran into a wave of water that knocked us out of the pipe. I landed in a pond below and got a large cut on my right t high but Kris was caught in some fishing wire right outside the tunnel. After about ten minutes of tugging and pulling we decided that I should go and get a knife to cut the wire since Kris was so entangled in it. So I got onto my bike and peddled through the forest with one leg since my other leg was in too much pain from the cut. I made it to a boat house and found a fishing knife and returned to Kris. He was beginning to get worried about his situation because the water kept getting colder. Even though he was only in about a foot of it. I cut him loose and we both went back to his house and tended to our wounds. The cut on my leg was bigger than I first thought it was, I ended up needing 13 stitches and was left with a very impressive scar. Throughout my whole bike ride to get the knife and return I was in constant pain and agony. My entire leg was covered with blood and dirt and washing it off in the pond's water only hurt more because the pond did not exactly have pure clean uncontaminated water. This was my sacrifice. To save my friend in spite of my pain. I very well could have stayed and spent another half an hour untangling my

friend, but his arm was starting to turn blue since his arm's blood circulation was cut off and I did not think we had time to waste. Plus our parents wanted us back home soon, so we needed to hurry for that reason too. Kris thanked me and was shocked that I did all that for him in spite of my painful wound. That is my most noble sacrifice that I can remember.

Chatroom 1

[REDACTED] i will get over him
REB DoMiNe: ok
[REDACTED] good question
[REDACTED] i am not sure
[REDACTED] prolly just when he compliments me
[REDACTED] but i get so aggrivated with him sometimes
[REDACTED] i dont think that i am in love really
REB DoMiNe: alright.
REB DoMiNe: doesnt sound like it
[REDACTED] no it doesnt
REB DoMiNe: but then again, remember this:
REB DoMiNe: love in my view means something different to everyone. what one person calls true
love can
REB DoMiNe: be just another cheap thrill to another
[REDACTED] i think i am just obsessed with the idea of a great boyfriend and hes the closest i got
[REDACTED] yeah i guess your right
REB DoMiNe: hm, that might be it
REB DoMiNe: might just want love so much we exaggerate our feelings
REB DoMiNe: and romantisize them
[REDACTED] i think that i am just comfortable with him and right now i dont feel comforatable
about
[REDACTED] much
REB DoMiNe: why do you feel comfortable with him?
REB DoMiNe: in othre words..what is so great about Mr. [REDACTED]?
[REDACTED] cus i know he likes me as a person
[REDACTED] we can talk about anything
[REDACTED] life goals
[REDACTED] hes alot like you
[REDACTED] only there
REB DoMiNe: damn
[REDACTED] and hes fun
REB DoMiNe: mhmm
[REDACTED] we can goof off or have a deep conversation
[REDACTED] see i am really insecure
REB DoMiNe: it doesnt seem like he can have a deep conv.
[REDACTED] and so when he tells me that i am his best friend and stuff it makes me feel needed
REB DoMiNe: just seems that he would say things like "yeah...i agree....yeah...uh huh....yeah"
REB DoMiNe: yeah.
REB DoMiNe: well, i can see that
[REDACTED] it is easier to have a deep conversation with people that i met in person in person
[REDACTED] because i need to look into their eyes
REB DoMiNe: ah.
[REDACTED] i need to see what they are feeling
[REDACTED] i dont know
[REDACTED] he has such beautiful eyes
REB DoMiNe: you see, i have never had any conv.s like this in real life
[REDACTED] i fall into them when i look at him
REB DoMiNe: so i wouldnt know.
[REDACTED] really never
REB DoMiNe: nope.
[REDACTED] do you not have many close girl friends
REB DoMiNe: just conversations at school about school things
[REDACTED] wow
REB DoMiNe: no, i hardly have any

[REDACTED] that seems strange to me
[REDACTED] i think with things like this it is easier to talk to people of the opposite sex
[REDACTED] i am not sure though
REB DoMiNe: heh. i have a bigass feeling you would hate quiet a few people here
[REDACTED] alot of fake people
REB DoMiNe: mhm.
[REDACTED] that dont think
REB DoMiNe: followers, airheads, losers, dumbasses
REB DoMiNe: yep
REB DoMiNe: they only think about social life instead of life life
[REDACTED] ahh that is so annoying
REB DoMiNe: mmmhm
[REDACTED] i hate people like that
[REDACTED] i am so glad that you arnt like that
REB DoMiNe: as am i
[REDACTED] it would be scary cus i prolly never would have met you
REB DoMiNe: call it fate or call it a coincidence...but i call it damn cool
REB DoMiNe: and good
[REDACTED] no kidding
REB DoMiNe: so, what do you think when you look at the stars?
REB DoMiNe: (to start a new topic)
[REDACTED] i tink wow they are so pretty
REB DoMiNe: ...i hope thats not all...
[REDACTED] i have no idea about another species
REB DoMiNe: go on
[REDACTED] i dont see how there couldnt be the universe is so big
REB DoMiNe: mhm
[REDACTED] but then i wonder why havnt we found em yet
REB DoMiNe: ah
[REDACTED] ya know i mean we have been searching for so long
REB DoMiNe: yeah
REB DoMiNe: and if there is other life, why havent they tried to contact us?
[REDACTED] i know why havnt they tried to find us
REB DoMiNe: u think because they dont want to?
[REDACTED] how do they live, communitcate, think, act look like?
[REDACTED] i am not sure really
[REDACTED] mbe they already found us adn didnt like us
REB DoMiNe: could be
REB DoMiNe: i know thats what i would think
[REDACTED] yeah i would think man as a whole this planet sucks and the people are pretty
[REDACTED] damn stupid
REB DoMiNe: yyyyyyyep
[REDACTED] we only use 10% of our brain, that i jst dont get
REB DoMiNe: yeah.
REB DoMiNe: and the people that use more than 10% are called crazy
REB DoMiNe: or stupid even!
[REDACTED] i know
[REDACTED] or freak
REB DoMiNe: mhm
REB DoMiNe: its all backasswards
[REDACTED] lol
[REDACTED] that is a funny word
[REDACTED] i will have to use it sometime

REB DoMiNe: you and me are the ones who should be running the world, not all these lameass
lying politic

REB DoMiNe: heh

[REDACTED] yah that would be so cool wed have all the answers

REB DoMiNe: i would love to be the ultimate judge...and say if a person lives or dies

REB DoMiNe: be godlike

[REDACTED] yeah could i be your goddess

REB DoMiNe: "you'll be godlike"-KMFDM

REB DoMiNe: hell yeah

[REDACTED] ho yeah

REB DoMiNe: like my quotes in my profile say, its only cool if i say so and it only sucks if i say so

[REDACTED] i would love to hold someones life in my hand

REB DoMiNe: me too.

[REDACTED] hey hold on i want to read your prof

REB DoMiNe: and say "you dont deserve to live, you are worthless, die"

[REDACTED] do you know how many people i would do that to

[REDACTED] the world would be a much smaller place

REB DoMiNe: someone once told me no one is worthless, maybe so, but they are definitely pointless

REB DoMiNe: there would be about 100 people left on earth if we could do that.

REB DoMiNe: have you ever seen that movie made for tv "the Stand" by steven king?

[REDACTED] no

[REDACTED] i dont think that people are worthless but i agree pointless

REB DoMiNe: check it out sometime. it has a nice view of the world after 98% of it is dead

[REDACTED] like their life is going nowhere

REB DoMiNe: yeah. and they only are helpful because of their "job"

[REDACTED] but some of them dont even have jobs

REB DoMiNe: like, yeah thanks you made a movie, so the flip what

[REDACTED] and half of them could be replaced by robots

REB DoMiNe: yes, very true

[REDACTED] hey so whats up
REB DoMiNe: wow im so glad i found u online. here i was just about to mail this to you:
REB DoMiNe: Well, i wrote my mom a 2 page note last night and put it on the counter. i told her about our conversations and why i stay up so late and how its my life and i am in control of it and a lot of other stuff that they have been bitching at me about. so we will have to see what they say
REB DoMiNe: about that when they get home from work tonight. im happy, i finally got the courage to tell my parents what i really think. i put it on paper so they wouldnt think i was "talking back" or haveing a "bad attitude" or something.
[REDACTED] wow i am so proud of you
REB DoMiNe: thanks!
[REDACTED] well you have to tell me evrything they say
REB DoMiNe: ok i will
[REDACTED] so you have to tell me bout your dream world
REB DoMiNe: alright. how long can you be online right now, i mean do we have time to talk?
[REDACTED] yeah i got all day no plans
REB DoMiNe: awesome. ok picture this: (typing)
REB DoMiNe: your in a large rectangular room, about 10 feet by 4 feet. it reminds you of the inside of a hull of a boat. there are old computer screens around you on the walls. except something is different about them, they are futuristic looking, but yet hundreds of years old. they are covered with dust and mold and vines. the only light in the room is from a full moonthat seems to dance around in the sky, so the shadows are all creeping around you.
now, in the front of the room, and on the ground, are
REB DoMiNe: windows, you can see out the windows and you are looking onto a vast sea. large hill of water going uuup and doowwwn constantly, the only sound is the wind and the movement of the water. the room that you are in is moving, like a blimp would. and you are just standing there, staring out into the sea.
REB DoMiNe: that is one place i have imagined i would like to be.
[REDACTED] wow kind of gloomy
REB DoMiNe: yeah. but its still nice. no people at all. kind of like, everyone is dead and has been for centuries.
[REDACTED] wow that does sound nice
REB DoMiNe:can only wish.
[REDACTED] i would love that but i would need some people
REB DoMiNe: eventually i would only want 1 or 2 people.
[REDACTED] i think i would want 4or5
REB DoMiNe: it would be tough to decide who though.
[REDACTED] not so much for me
[REDACTED] i keep my friends close
REB DoMiNe: what kind of people would you want with you?
[REDACTED] i know for sure my best friends
and you
REB DoMiNe: =] thanks.
[REDACTED] sure
[REDACTED] i hope you could stand my friends
REB DoMiNe: if everyone was dead except say 4 or 5 of us. would you want to build up a new human race or eventually let us go extinct?
[REDACTED] i think i would want us to go extinct but it would be inevitable that people would have sex
REB DoMiNe: true.
REB DoMiNe: maybe if we were all sterile. (couldnt reproduce)
[REDACTED] it just is inevitable
[REDACTED] he he
REB DoMiNe: yeah.
[REDACTED] smoking seeds makes you sterile
and i think all stupids should be steril anywy
REB DoMiNe: yeah, in our dreams. it would be great if we were that lucky
REB DoMiNe: i dont think i would want to bring a child into this world.
[REDACTED] he he been around hte world and found that only stupid people are breeding

[REDACTED] why too many stupid
REB DoMiNe: maybe its natures way.
REB DoMiNe: yeah.
REB DoMiNe: jst the world itself.
REB DoMiNe: i dont know.
REB DoMiNe: but i think i would want us to go extinct also.
[REDACTED] i know what you mean we are all peices of shit
REB DoMiNe: but i would definitely leave behind some things.
[REDACTED] yeah
REB DoMiNe: like ancient civilizations have done. (pyramids, stone hedge, etc)
REB DoMiNe: rrrrrr. i just wish i could actually DO this instead of just DREAM about it all
[REDACTED] yeah i always wonder what we have done and left behind that others will wonder about
REB DoMiNe: lately we havent left anything worth leaving.
[REDACTED] i know
REB DoMiNe: just buildings. yey doggie.
[REDACTED] yey doggie?
REB DoMiNe: woopdy doo. woo fucking hoo. big deal etc etc
[REDACTED] oh ok
[REDACTED] i am a little slow at times
REB DoMiNe: why cant we make anything like the pyramids any more.
REB DoMiNe: oh dont worry, i can be slow as hell sometimes.
[REDACTED] he he
[REDACTED] i thin we are just incapable of making anything amazing
REB DoMiNe: i think yer right.
REB DoMiNe: we only make things that "look" neat. nothing has any depth or meaning.
[REDACTED] yep just as long as it is good on the surface
REB DoMiNe: mhm
[REDACTED] but all that shimmers is not gold
REB DoMiNe: yeah....silver too. heh.
REB DoMiNe: atleast in societies mind
[REDACTED] yeo
[REDACTED] yep
REB DoMiNe:ugh
[REDACTED] what that mean
REB DoMiNe: nothin really. just thinking.
REB DoMiNe: bout what we were talkin about
[REDACTED] makes me mad too

#1

The first quote I chose to write on is, "No one knows he is fortunate until he becomes unfortunate." In the book, this quote has a lot of significance. Such as when Reuven was in the hospital recovering from his wound. When he was looking outside at the people walking in the fresh air, he remembered how he took his everyday walks for granted. He took many things for granted in the beginning of the book. But when he was in the hospital, he realized how fortunate he was. One other thing he took for granted was his eyesight. His eyesight wasn't even something he ever paid much attention to, but once it was taken away, he realized how important it was and how much everyone takes it for granted. When he was in the hospital, he realized that he had lost many normal activities. Such as walking, seeing, reading, and to just be free. I believe that we all take things for granted. Then once we loose that privilege, we realize how fortunate we were. Personally, this quote is very true. I have had many experiences where something was taken away from me that I used every day. Such as when I had surgery on my chest. When I got back from the hospital, I couldn't do anything that involved using my chest muscles. This meant I barely could even laugh. I learned then how many things I took for granted.

#2

The second quote I chose to discuss is "Things are always what they seem to be, Reuven? Since when?" This quote is very significant in the novel because of Reuven and his prejudice against Danny and the Orthodox Jews. He thought, at first, that Danny was an evil, "snooty" person that wanted to kill him. Then later he realized that Danny was a very intelligent,

thoughtful, and caring human being just like himself. There were many points in the novel in which things were not as they seemed. Such as when Danny hit the baseball at Reuven's head. Reuven thought that Danny did it on purpose but he really wasn't aiming for Reuven. Another point in the novel might have been when he was wearing his glasses at the baseball game in the beginning of the novel. He saw several things that to him, seemed bad or different, but later he sees that those things were normal just like him. Like Dov, the boy who ran into Reuven during the game. It seemed to Reuven that he was a mean bully, but later he sees him in the synagogue and sees that he is just like everyone else. Personally, this quote means a lot to me. I have had countless experiences in which I thought I was sure about something, then later it becomes the opposite of what I thought. Such as when I had a friend that at first, he seemed to be a normal friend just like my others. Then he lied and turned on me, for no reason, and tried to get me in trouble and trying to get money out of me. This is probably the best example in my life of this quote. I have learned in my life to never believe first impressions, and always look a little deeper, because things aren't always the way they seem.

During the early nineteenth century the Congress of Vienna and the European Settlement played major roles in shaping Europe after the invasion of Napoleon. Napoleon was defeated, treaties were formed, alliances were erected, the Congress of Vienna settled problems of territory and French boundaries, Napoleon was defeated again at Waterloo, and peace was eventually laid down in Europe.

After Napoleon was defeated at Leipzig in October of 1813, he went into exile on an island off the coast of northern Italy. European countries wanted to restore power to what it was before Napoleon so the Treaty of Chaumont was formed. One of the most important figures in this settlement was a British foreign secretary named Robert Stewart, Viscount Castlereagh. The treaty provided that the Bourbons be restored to the French throne and France would be contracted to its boundaries of 1792. The Quadruple Alliance between Britain, Austria, Prussia, and Russia was also formed. The other remaining problems were to be solved at the Congress of Vienna.

The congress of Vienna lasted from September 1814 to November 1815 and was mainly assembled to settle territorial disputes. The Bourbon monarchy was restored and the boundaries were cut to keep France content. Also, several states were created around France to act as barriers to any more French expansions. Monarchs were to govern these states as well, as to stop any republican or democratic form of government that followed the French Revolution. This settlement of eastern Europe sharply divided the great powers.

Russia wanted to rule all of Poland, Prussia wanted all of Saxony, Austria did not want to give up Poland or see Prussia gain power and Russia to grow deeper into Europe. The Polish-

Saxon question almost brought the countries to war but Talleyrand, a representative of France, solved this problem. He suggested that Russia might agree to their demands if France, Austria, and Britain were to have a secret treaty. This caused the Russian tsar to agree to becoming ruler of a smaller Poland and Prussia would only accept part of Saxony. This led to France being included with the great powers since it peacefully and wisely solved a large problem between the great powers.

However, on March 1, 1815 Napoleon returned to France and revived his still loyal army. The major European leaders saw this as a great threat and sent their armies to crush Napoleon. He was defeated and sent back into exile at the battle of Waterloo on June 18. The period of time in which Napoleon was leader again is called the Hundred Days, and this period of time made peace hard for the great leaders of Europe. Austria, Russia, Prussia, and Britain wanted to prevent any more episodes like this, so Russia suggested a Holy Alliance. This would be an alliance whereby the monarchs promised to act together in accordance with Christian principles. England refused to sign the treaty and the Quadruple Alliance was then renewed. The Holy and Quadruple Alliances were formed to keep peace in Europe and prevent other leaders like Napoleon from taking control of Europe again. France was proposed to be put under military rule but eventually a legalistic balance of power and methods for adjusting to change was used.

The main goals of the Congress of Vienna was to arrange an acceptable settlement of Europe that would have lasting peace and to prevent another Napoleonic era. The goals were met very well. No more leaders like Napoleon came to power and no war broke out for years. France accepted the new situation with ease and the great powers solved their problems reasonably. The only thing the congress did not accomplish was recognizing and providing for

the great forces of nationalism and democracy that would stir the next century. The congress could not have anticipated these great powers to come or yield to forces they disapproved.

In general, the Congress of Vienna and the formation of the Quadruple Alliance kept peace for about 50 years and no major hostile conflicts for 100 years.

Eric Harris
4/11/96
Period 2

BOOK REPORT CORRECTIONS

1. The reason I did not capitalize the name of this book is because I was slightly confused. I thought that you were supposed to put quotation marks around the title instead of underlining it.
2. The reason I did not type out "can't" is because I am used to using shortcuts. For a long time now I have been using shortcuts in my papers and I forget that you have to write out words completely, instead of using a contraction.
3. The reason I did not underline the title of this book is because I was still confused. Just like the first time I did this at the beginning of the report, I was not sure if I should have underlined or put quotations around the title of the book.

**Nature is evil
in Macbeth.**

Eric Harris

9/29/98

period 5

Webb

Eric Harris
Period 4
10/10/96
Question #4

In *The Crucible*, John Procter displays a great amount of courage. In the story, John Procter did many courageous acts. One such act was when he confessed to lechery, another was when he said his wife would never lie, and the last was when he tore up his confession statement.

Confessing to lechery took an extremely great amount of courage to do. He confessed to make Abigail look like she was lying and to show the court that all the girls were lying. By confessing to lechery John Procter ruined his own reputation and made his wife feel horrible. It takes a great amount of courage to confess to such an awful sin like lechery. Another courageous act was when John Procter told the court that his wife has never and will never lie. This was courageous because he just confessed to lechery and his wife didn't know about it. Since she would want to protect him, she would probably lie to save his name. Also, she would never tell the court that her husband was a lecher because that would give her a bad name too. John did not know exactly what his wife would say, so he took the risk and said that she would never lie. The last main act of courage by John Procter is when he denied being a part of witch craft. Not only did John deny being a witch, but he tore up the confession in front of the judge. This act cost him his life because after he tore it up Reverend Hale said, "Man, you will hang!" However, this courageous act saved his name and soul because he didn't lie and didn't let the court make him do anything against his will. John knew he would hang if he didn't confess, so at first he did confess. However, since he did not put his full name on the confession

statement, the judge said it was not a valid confession. John was enraged that they wanted to not only make him lie and confess, but they also wanted him to ruin his name permanently. He would never do that so he tore up the paper. This was the ultimate act of courage and bravery.

John Procter did many courageous things in *The Crucible*. Some of his most courageous acts were when he confessed to lechery, when he told the court that his wife would never lie, and when he tore up his confession to the court about witch craft.

des Model

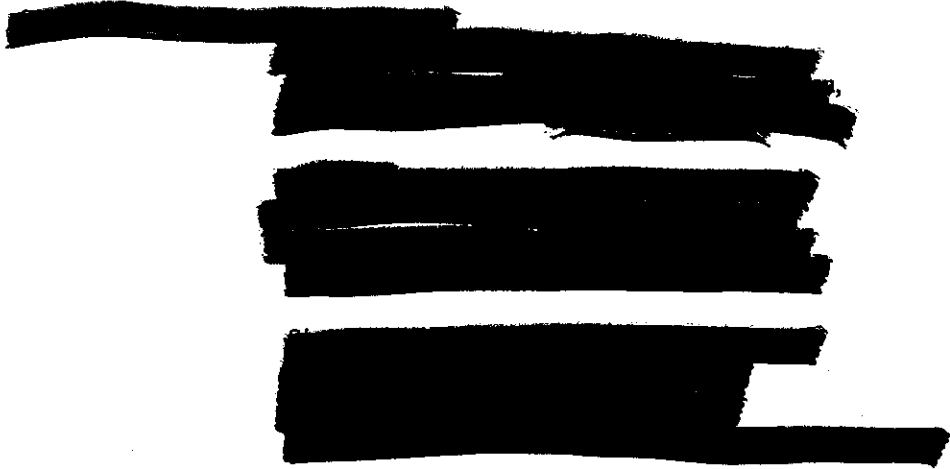

du hast

du hast



you



NOTE: "du hast" is difficult to translate because some ambiguities are lost in the process: "du hast" literally is "you have" but sounds exactly like "du hasst" which means "you hate". This is the same for "du hast mich", which is "you have ... me" but sounds like "you hate me". So they're building the sentence "du hast mich gefragt" word by word, which I can't do in english (word order). However "du hast mich gefragt" has no ambiguity in it, so only when you hear this part it becomes clear, they're singing "you have" and not "you hate"...

Du riechst so gut: D

You smell so good:

Translation by: REB

JC-001-026588

du riechat so gut

Du riechst so gut:

[REDACTED]

You smell so good:

[REDACTED]

Translation by: REB

JC-001-026589

elements

Al	aluminum
Ar	argon
As	arsenic
Ba	barium
Be	beryllium
B	boron
Br	bromine
Cd	cadmium
Ca	calcium
C	carbon
Cs	cesium
Cl	chlorine
Cr	chromium
Co	cobalt
Cu	copper
F	fluorine
Fr	francium
Au	gold
He	helium
H	hydrogen
I	iodine
Fe	iron
Kr	krypton
Pb	lead
Li	lithium
Mg	Magnesium
Mn	manganese
Hg	mercury
Ne	neon
Ni	Nickel
N	nitrogen
O	oxygen
P	phosphorus
Pt	platinum
K	potassium
Ra	radium
Rn	radon
Rb	rubidium
Se	selenium
Si	silicon
Ag	silver
Na	sodium
Sr	strontium
S	sulfur
Te	tellurium
Th	thorium
Sn	tin
W	tungsten
U	uranium
Xe	xenon
Zn	zinc

engel

engel



engel [angel]

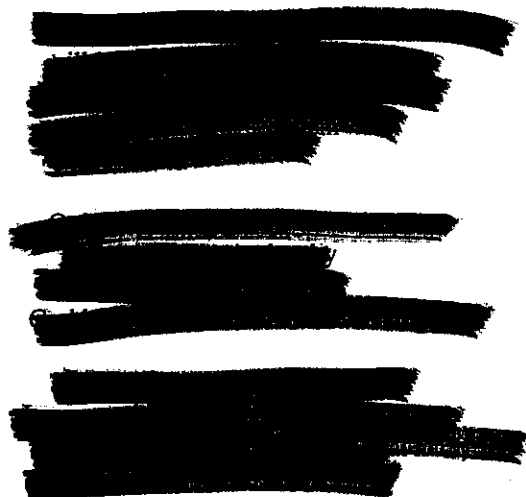

Chorus...

entrance Essay

Eric Harris
Period 5, 8/31/98
Webb

Picture an Earth that has been obliterated by nuclear war and alien attacks leaving cities and military forces in ruins with only a lone marine as humanity's last fighting force. Picture holographic walls, crushing ceilings, oceans of blood and lava, strange ancient artifacts, and horrible sour lemon and rotten meat stench in the air. Imagine being trapped on an abandoned cold steel base floating in space for eternity, a leathery skinned monster roaming under a strobe light waiting for a fight, and astonishing weaponry designed to your special needs. All these places and ideas have been created and recreated many times by yours truly.

It can be hard to be original in our generation, with so many movies, books, published ideas, and songs that can be copied. People can combine ideas from several different fields and mix them into a new trend or fashion but, in reality, it is just more of the same. In order to tell of my creative talents, I must first tell my view on "creativity." My mind is so full of creative, original ideas that sometimes I have trouble keeping them at bay. For the past three years, I have been involved in a computer game called Doom. Even though one might think it is just a game, I believe it is one of the best ways to show my creativity and intelligence.

I believe creativity is a term that is relative to the observer. What one person may think is completely incredible and uncanny, another might think is just more of the same. In reality they both can be correct. I think that about a third of what an average high school student says in one day can be found in a movie or a book. While that student may not be plagiarizing on purpose, someone else might think they are. My point is that, for me, it is hard to describe my creative talents and to be sure that they are original and unique at the same time.

Doom is a first-person "shoot-em-up" style game. So basically, one runs around levels and shoots at monsters with military weaponry. To most people it may be just another silly computer game, but to me it is an outlet for my thoughts and dreams. I have mastered changing anything that is possible to change in that game, such as the speed of weapons, the strength and mass of monsters, the textures and colors used on the floors and walls, and greatest of all, the actual levels that are used. Several times I have dreamed of a place or area one night, and then thought about it for days and days. Then, I would recreate it in Doom using everything from places in outer space with burned-out floor lights and dusty computers to the darkest depths of the infernal regions with minotaurs and demons running at me from every dark and threatening corner. I have also created settings such as eras of ancient abandoned military installations deep in monster-infested forests with blood stained trees and unidentifiable mangled bodies covered with dead vines and others that portray to futuristic military bases on Mars overrun with zombies that lurk in every corner. These places may seem a bit on the violent side and, I assure you, some of them are. However, many times I have made levels with absolutely no monsters or guns in them. I have created worlds with beautiful, breath taking scenery that looks like something out of a science fiction movie, a fantasy movie, or even some "eldritch" from H. P. Lovecraft.

Now, I know that other people are just as creative or more creative than I am, but I believe that I will always be the best at Doom creativity. In this day and age it can be hard to find a skill that can be completely dominated and mastered or a skill that almost no one else has. This is why I choose a simple computer game to express my talents.

The children and the birds in the short stories 'White Heron' and 'Scarlet Ibis' will be compared and contrasted in terms of appearance, how they were used in the story and how the children protected the birds. The short story 'White Heron' was about a little city girl that moved to the country and protected a bird, the White Heron, from being found by a hunter. In the story the little girl always wore a white dress, symbolizing goodness, purity, and kindness, and the White Herons' feathers were also white. The short story 'Scarlet Ibis' is about a boy that was born very weak and everyone thought he would not live, but with the help of his ashamed older brother, he learned to walk and be like all the other boys. One day after Doodle, the little boy, had buried a Scarlet Ibis that had died from exhaustion from a storm he was killed in a heavy rain and lightning storm. Doodle was a thin, red colored, crippled boy that died in the shape of an 's' and the Scarlet Ibis had red feathers, was very weak, and died like an 's' also. The little girl and Doodle were used in the stories as protectors and saviors for the birds. The little girl in the 'White Heron' protected the bird how she wanted to be protected and tried to keep the birds nest a secret. Doodle also protected the Scarlet Ibis by burying it after it had died. Doodle and the little girl were different in appearance because the little girl symbolized goodness and Doodle symbolized death, agony, and suffrage. The difference between the usage of the children and birds in the stories was that Doodle was used as a sorry and crippled boy. On the other hand the little girl was perfect and wore a white dress all the time. The birds were different because the Scarlet Ibis was only in the story near the end and died, but the White Heron was a main part or conflict in the story and lived. The way the children protected the birds was different because Doodle only buried the bird and didn't save it from any danger. On the contrast, the little girl saved the white

heron from the hunter by not telling him where it was and also protected the bird the way she would want to be protected. I compared and contrasted the children and the birds in the short stories 'White Heron' and 'Scarlet Ibis' by means of appearance, how they were used in the story, and how the children protected the birds.

f

Fading, failing, fainting, faking, falling, faltering, fanning, farming, fasting, fattening, faulting, favoring, feasting, feeding, feeling, fencing, fending, fertilizing, festering, fetching, feuding, fibbing, fiddling, fidgeting, fielding, fighting, filing, filling, finding, fining, fingering, finishing, firing, firming, fishing, fitting, fixing, fizzing, flagging, flaring, flaking, flaming, flanking, flapping, flaring, flashing, fleeing, flexing, flicking, flipping, flirting, flinching, floating, flocking, flooding, flopping, flossing, flowing, flubbing, fluffing, flunking, flushing, fluxing, flying, foaming, fogging, foiling, folding, forcing, forging, forking, forming, formatting, framing, franking, freezing, frizzing, frying, fueling, fumbling, fussing.

Final map

Trenchcoat Mafia

Hit-Men

For Hire

Eric Harris

Period 2

12/10/98

T-dog

JC-001-026598

Table-of\ -Contents

- 1: Product Overview**
- 2: Map**
- 3: Business Organization**
- 4: Fund Raising**
- 5: Advertising Campaign**
- 6: Conclusion**

Product Overview

In this city, protection is needed. Day by day people grow more and more agitated with one another and become less understanding and forgiving. Even though programs made by anti-hate groups and police try to keep people from being prejudiced and having stereotypes, most people are still the same.

The so-called "Trench Coat Mafia" is a small group of friends who generally wear dark clothes, military fatigues, and long black dusters. Most people usually just stare and whisper when they see us. We don't mind because we generally don't like people anyway. Now they have reasons to stay clear of us.

JC-001-026600

MAP

This map depicts our current locations. We are located in a few different houses in the Columbine area, along with a safe location in the mountains. We also have connections with people in Mexico, Germany, South Africa, and New York City. The locations in the Columbine area are strategically positioned so we can launch attacks in almost any neighborhood with a few minutes notice. We also have caches of weaponry and explosives located around the CHS area and in certain fields, all to serve you, the customer.

JC-001-026601

Business Organization

Now, with more and more violent fights and nearby gang activity at locations like Chatfield, we believed that we needed to start a business. The business is basically to kill people who anger our clients. Hence, the "Trench Coat Mafia Hit-Men for Hire" business was created. Several weapons, such as a sawed-off pump-action riot-gun, an AB-10 machine pistol, home made rocket launchers, swords, and daggers were gathered to help our business. Now on school grounds we can't be armed. Everyone knows that if someone is caught with a weapon they are suspended or expelled, which would not help my business at all. Therefore, using our resourceful home computers, we acquire the full name, telephone number, and address of our target. Then we hunt the target down and relocate him/her to one of several secluded areas, like the bottom of a lake.

Fund Raising

As far as costs are concerned, we can be pretty lenient. For underclassmen, the cost is \$50 a day for general protection. For upperclassmen it is \$20 a day. Now if you wanted someone so intimidated that they would not even get out of bed in the morning, that costs about \$100. Assaults and beatings can range from \$200 to \$500, depending on the severity. For relocation of problem targets, the price is usually between \$1,000 and \$10,000. It basically depends on the location and time of the hit, as well as if there will be witnesses or if it requires us to take out a whole group of targets.

We raised enough money to start our business strongly. Most of the money came from personal reserves. We also got money from relocated targets. Weaponry we already had, and ammunition isn't too expensive these days. Political contributions are the main expense.

Advertising Campaign

Our advertising campaign is quite simple. We don't want to start a war, at least not yet, so we can only help certain groups of people. We will help whoever is willing to pay the most for our protection. It is a first-come-

first-served basis. My business will reach the intended audience by word of mouth alone. That may seem like we wouldn't get many clients, but we have already made \$20,000 since we started the business only a few weeks ago.

So if you need our help, just come up to me, or one of my associates, and tell us a little about yourself and your problem. We'll see what we can arrange for you.

Conclusion

The fact is that people need protection from the dangers of every-day encounters and the "Trench Coat Mafia" is willing to protect you. For a small cost, you can walk the halls knowing that you have your very own personal guards keeping a close eye on you. No one, no matter what size, will give you any trouble.

gatsby

Wasting Money

by

Eric Harris

period 1

5/12/97

Mrs. Caruthers

In the story, The Great Gatsby, there were many different themes. One of the most outstanding themes was the use of money in society. The West egg was the middle class section of the community and the East is where the higher class lives. Nick, Tom, Daisy, and Gatsby all live in the higher class section. Many of them have used their money unconsciously or wastefully.

Gatsby used his money in many wasteful ways. Some of these ways might have seemed unimportant or insignificant, but when one looks back on the story, these acts will look strange. Such as, when Gatsby and friends rented a luxurious hotel sweet for a few hours. Gatsby also went flying in his expensive air plane often and acted as if it was no big deal. Since he never truly worked for his money, he doesn't know how to enjoy his money and spend it wisely.

Tom and Daisy also used their money wastefully. Most of all though, they were inconsiderate. Throughout the story Tom and Daisy treated their child as if she was a piece of furniture. They would call her down and look at her, then send her back up to her room. Never thinking about her feelings and her needs for love and care. The most likely cause for their actions is probably their money. Since they did not earn it by working, they were spoiled and their inconsiderate actions were just a side effect.

In F. Scott Fitzgerald's novel, The Great Gatsby, there was a wide use of themes. One of the larger themes was money. Many of the citizens living on the East egg used money quite wastefully. Since most of the rich people got their money by inheriting it, they do not know how to work or do any thing else by themselves. In my opinion, those people are inconsiderate, selfish and they do not deserve to be at the top of society.

guilty

guilty

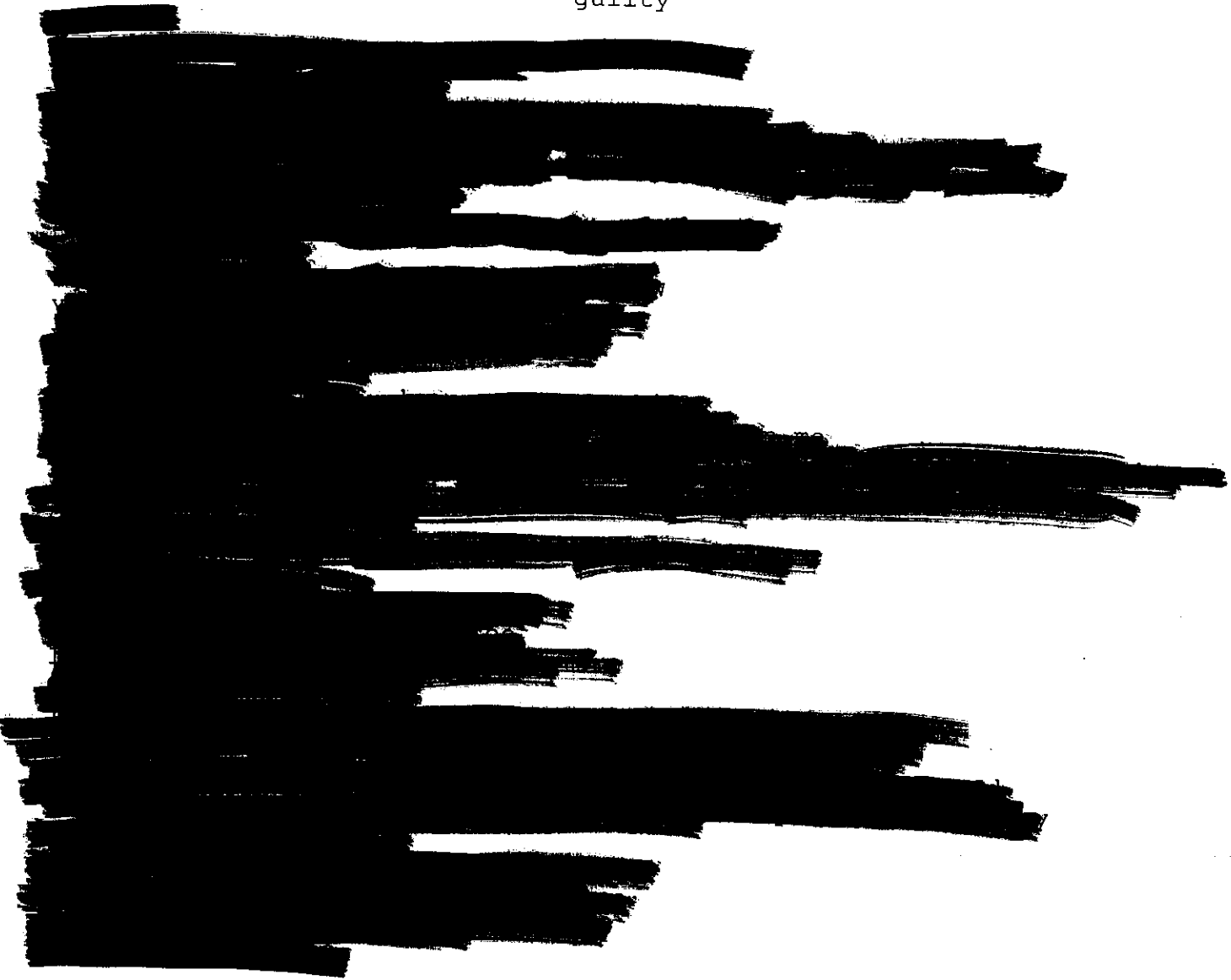

guns

Eric Harris

Period 4

R.D.

Guns! Boy, I loved playing “guns” as a kid. It is one of the few things I miss from childhood today. Living in a rural town in Michigan for three years, I played a lot in a forest. My brother, two friends and I would always be running around shooting imaginary bad-guys. The woods behind my house were vast, empty, and old. It smelled of a musty tree or maybe of pine trees most of the time in there. Those woods left so many memories in the mind it’s amazing. Such as how scary they looked during hard rain storms or how dark they were at night. I was even afraid to go into the woods during nighttime, for fear of the unknown. For the most part, however, my memories are fond ones. My brother, Sonia, and I had countless missions in those woods, hunting for enemy troops and stopping invasions. We would set up little tree fort made of loose sticks and branches, and use them for our bases and camps. “Fire!” I would scream, as we all made as many fast gun sounds as we could, waving our deadly plastic toys around. Almost every time we had a firefight, we would pretend one of us would be injured. We always would carry little bandages and tape with us to dress the wound. Luckily, the bullet would always go right through so we wouldn’t need to perform surgery. Sonia, being her crazy self, would run right into the battle screaming and firing at all the bad guys, as we gave cover fire. It seemed so vivid, our fighting, and so real. Now that I have actually fired weapons I realize how unrealistic we were, but hey, we were just kids!

“Where’s the air support?!” my brother screams, as I reload my M16. “Hell if I know!” I retort. “We got more incoming APCs on our 6’s, set those mines quick!” Sonia hollers. The bad guys were surrounding us, but we had plenty of ammo to last us for hours. I toss a few stick grenades into the trees ahead, and duck as they go off killing the wave of enemy troops. Kevin was setting the mines for those trucks and Sonia was

JC-001-026609

launching rockets at the platoon on our left. "Grenade!" I scream as I see a stick fall in our base. Sonia and I jump out over the tree trunks as the grenade destroys our base. "We gotta move, now!" Sonia yells in my ear under all the shooting. We run right past my brother and he joins up in the evacuation. Just then our air support flies by overhead. "There's the gun-ships!" says my bro., as we dodge tree limbs, bullets, and mortars. We stop at a group of rather large trees and turn and return fire. The air support is dropping napalm on the advancing troops, and launching rockets at the trucks. We pull out a huge machine gun and set it up on a stationary position in a tree. Sonia and Kevin start spraying bullets everywhere as I use hand-to-hand combat on a few bad guys that made it to us. By the time I finish them off with a really strong stick, it's time to go inside and do some homework, and Sonia needs to go out to dinner with her family tonight, too. All in a day's work as a kid, I guess.

One of these days, real soon, I will call up Sonia and see if she still remembers me. And see if those woods, our forts, and our hide-outs are all still there where I left them over seven years ago.

Guns in School: Solution

Guns in schools are a growing problem in today's society. Every day the news broadcasts stories of students shooting students, or going on killing sprees, or even just bringing a gun to school. Students bring guns to school for many reasons. Some for protection, some for attacking, and even some to show off. However, a school is no place for a gun. Solutions for this problem are hard to come by and often too expensive for most schools to even consider. Metal detectors and more police officers are two very good solutions, though.

Metal detectors posted at entrances in schools can prevent guns from entering schools. That is a given fact. Although, the cost of these machines are rather high and some schools simply can not afford them. Tax payers and donations are other ways to form money to buy detectors, but some tax payers would not be happy with the prices. Several schools in the United States have metal detectors, and shootings still take place in the school. Students can be very resourceful, and can find ways to avoid the detectors. The idea of more police officers is a very good solution. However, this would also cost more money for the tax payers. The end result, in my opinion, is worth every penny spent.

Police officers can discourage students from bringing weapons and can stop anyone who manages to get a weapon in the school. They are there to protect and serve, so students can go to them if they want to report someone with a gun or any other incident. More cops in schools is a great start to preventing more shootings in schools. On the other hand, the more cops in a school the more it begins to look like a prison. The community does not want its schools looking like jail houses with the children as the prisoners. They are there to learn, and if students feel uncomfortable, that only leads to more problems. Drop-outs, grades, and student moral would

all get worse with the presence of police. Even though the cops are there for the students safety. Therefor, only a few cops should be assigned to schools at first. Let them get familiar with the students and let the students get to know the officers. This will help the moral of the student body.

Metal detectors and other forms of detectors are very good solutions. Once installed in all main entrances, students can simply walk through while trained officers can search suspicious bags and backpacks if the alarm goes off. Students will be much more safe, but the fact of low moral is still present. One problem with metal detectors is that several school-related items are metal and would most likely set off the alarm. This leads to several searches that turn up nothing. This can cause long lines and be a hassle for students.

More and more we hear of shooting sprees and rampages on the news. Some can be prevented, some can not. Almost any school shooting could have been prevented in some way or another, we just have to spend the necessary time and money to figure out how. Metal detectors and more police officers are only two good solutions. If tax payers can afford to do one or both of these solutions, then that is fantastic. If not, then the community needs to figure out other ways to keep guns out of schools. Students can not learn very well and be motivated if they know that someone in their classroom has a gun with them. In conclusion, metal detectors and more police officers are a great start to the fight against guns in school.

Helmer

Helmer=Eric Harris

Nora=

Maid=

The scene starts right after Torvald has read the letter from Krogstad.

Helmer: NORA!

Nora: [*screams*] Oh--!

Helmer: What is this? You know what's in this letter?

Nora: Yes, I know. Let me go! Let me go!

Helmer: [*holding her back*] Where are you going?

Nora: [*struggling to break loose*] You cant save me, Torvald!

Helmer: [*slumping back*] True! Then its true what he writes? How horrible! No, no its impossible—it cant be true...

Nora: It -is- true. I've loved you more than all this world.

Helmer: Ah, none of your slippery tricks.

Nora: [*taking one step toward him*] Torvald--!

Helmer: What is this you've blundered into!

Nora: Just let me loose. You're not going to suffer for my sake. You're not going to take on my guilt.

Helmer: [*walks over to hall door*] No more play acting.[*locks it*] You stay right here and give me a reckoning. You understand what you've done? Answer! You understand!?

Nora: [*looking squarely at him, her face hardening*] Yes. I'm beginning to understand everything now.

Helmer: [*striding about*] Oh, what an awful awakening! In all these eight years—she who was my pride and joy—a hypocrite, a liar—worse, worse—a criminal! How infinitely disgusting it all is! The shame! [*NORA says nothing and goes on looking straight at him. He stops in front of her.*] I should have expected something of the kind. I should have known. All your father's flimsy values---BE STILL!--All your father's flimsy values have come out in you. No religion,

no morals, no sense of duty—Oh, how I'm punished for letting him off! I did it for your sake, and you repay me like this.

Nora: Yes, like this.

Helmer: Now you've wrecked all my happiness—ruined my whole future. Oh, it's awful to think of. I'm in a cheap little grafter's hands; he can do anything he wants with me, ask for anything, play with me like a puppet—and I can't breathe a word. I'll be swept down miserably into the depths on account of a featherbrained woman.

Nora: When I'm gone from this world, you'll be free.

Helmer: Oh, quit posing. Your father had a mess of those speeches too. What good would that ever do me if you were gone from this world, as you say? Not the slightest. He can still make the whole thing known; and if he does, I could be falsely suspected as your accomplice. They might even think that I was behind it—that I put you up to it. And all that I can thank you for—you that I've coddled the whole of our marriage. Can you see now what you've done to me?

Nora: [*icily calm*] Yes.

Helmer: It's so incredible, I just can't grasp it. But we'll have to patch up whatever we can. Take off the shawl. I said, take it off! I've got to appease him somehow or other. The think has to be hushed up at any cost. And as for you and me, it's got to seem like everything between us is just as it was—to the outside world, that is. You'll go right on living in this house, of course. But you can't be allowed to bring up the children; I don't dare trust you with them—Oh, to have to say this to someone I've loved so much! Well, that's done with. From now on happiness doesn't matter; all that matters is saving the bits and pieces, the appearance-- [*doorbell ring, HELMER starts.*] What's that? And so late. Maybe the worst--? You think he'd--? Hide, Nora! Say your sick. [*NORA remains standing motionless. Helmer goes and opens the door.*]

Maid: [*half dressed, in the hall*] A letter for Mrs. Helmer.

Helmer: I'll take it. [*snatches the letter and shuts the door*] Yes, it's from him. You don't get it; I'm reading it myself.

Nora: Then read it.

Helmer [*by the lamp*] I hardly dare. We may be ruined, you and i. But—I've got to know. [*Rips open the letter, skims through a few lines, glances at an enclosure, then cries out joyfully.*] NORA! [*NORA looks inquiringly at him.*] Nora! Wait!--better check it again—Yes, yes, it's true. I'm saved. Nora, I'm saved!

Nora: and I?

Helmer: You too, of course. We're both saved, both of us. Look. He's sent back your note. He says he's sorry and ashamed—that a happy development in his life—oh, who cares what he says! Nora, we're saved! No one can hurt you. Oh, Nora, Nora—but first, this ugliness all has to go. Let me see..*[takes a look at the note]* No, I don't want to see it; I want the whole thing to fade like a dream. *[tears the note and both letter to pieces, throws them into the stove and watches them burn]* There—now there's nothing left— He wrote that since Christmas Eve you—Oh, they must have been three terrible days for you, Nora.

Nora: I fought a hard fight.

Helmer: And suffered pain and saw no escape but—No, we're not going to dwell on anything unpleasant. We'll just be grateful and keep on repeating: it's over now, it's over! You hear me, Nora?! You don't seem to realize—it's over. What's it mean—that frozen look? Oh, poor little Nora, I understand. You can't believe I've forgiven you. But I have Nora; I swear I have. I know that what you did, you did out of love for me.

Nora: That's true.

Helmer: You loved me the way a wife ought to love her husband. It's simply the means that you couldn't judge. But you think I love you any the less for not knowing how to handle your affairs? No, no—just lean on me; I'll guide you and teach you. I wouldn't be a man if this feminine helplessness didn't make you twice as attractive to me. You mustn't mind those sharp words I said—that was all in the first confusion of thinking my world had collapsed. I've forgiven you, Nora; I swear I've forgiven you.

Nora: My thanks for your forgiveness. *[she goes out through the door...right]*

Helmer: No, wait--*[peers in]* What are you doing in there?

Nora: *[inside]* Getting out of my costume.

Helmer: *[by the open door]* Yes, do that. Try to calm yourself and collect your thoughts again, my frightened little songbird. You can rest easy now; I've got wide wings to shelter you with. *[walking about close by the door]* How snug and nice our home is, Nora. You're safe here; I'll keep you like a hunted dove I've rescued out of a hawk's claws. I'll bring peace to your poor, shuddering heart. Gradually it'll happen, Nora; you'll see. Tomorrow all this will look different to you; then everything will be as it was. I won't have to go on repeating I forgive you; you'll feel it for yourself. How can you imagine I'd ever conceivably want to disown you—or even blame you in any way? Ah, you don't know a man's heart, Nora. For a man there's something indescribably sweet and satisfying in knowing he's forgiven his wife—and forgiven her out of a full and open heart. It's as if she belongs to him in two ways now: in a sense he's given her fresh into the world again, and she's become his wife and his child as well. From now on that's what you'll be to me—you little...bewildered...helpless thing. Don't be afraid of anything, Nora; just open your heart to me, and I'll be conscience and will to you both--*[NORA enters in her regular clothes.]* What's this? Not in bed? You've changed your dress?

Nora: Yes, Torvald, I've changed my dress.

Helmer: But why now, so late?

Nora: Tonight I'm not sleeping.

Helmer: But Nora dear..-

Nora: [*looking at her watch*] It's still not so very late. Sit down, Torvald; we have a lot to talk over.[*she sits at one side of the table.*]

Helmer: Nora...what is this? That hard expression..-

Nora: Sit down. This'll take some time. I have a lot to say.

Helmer: [*sitting at the table directly opposite her*] You worry me, Nora. And I don't understand you.

Nora: No, that's exactly it. You don't understand me. And I've never understood you either—until tonight. No, don't interrupt. You can just listen to what I say. We're closing out accounts, Torvald.

Helmer: How do you mean that?

Nora:[*after a short pause*] Doesn't anything strike you about our sitting here like this?

Helmer: What's that?

Nora: We've been married now eight years. Doesn't it occur to you that this is the first time we two, you and I, man and wife, have ever talked seriously together?

Helmer: What do you mean---seriously?

Nora: In eight whole years—longer even—right from our first acquaintance, we've never exchanged a serious word on any serious thing.

Helmer: You mean I should constantly go and involve you in problems you couldn't possibly help me with?

Nora: I'm not talking of problems. I'm saying that we've never sat down seriously together and tried to get to the bottom of anything.

Helmer: but dearest, what good would that ever do you?

Nora: That's the point right there: you've never understood me. I've been wronged greatly, Torvald—first by Papa, and then by you.

Helmer: What! By us—the two people who've loved you more than anyone else?

Nora: [*shaking her head*] You never loved me. You've thought it was fun to be in love with me, that's all.

Helmer: Nora what a thing to say!!

Nora: Yes, it's true now, Torvald. When I lived at home with Papa, he told me all his opinions, so I had the same ones too; or if they were different I hid them, since he wouldn't have cared for that. He used to call me his doll-child, and he played with me the way I played with my dolls. Then I came into your house..-

Helmer: How can you speak of our marriage like that?

Nora: [*still going on*] I mean, then I went from Papa's hands into yours. You arranged everything to your own taste, and so I got the same taste as you—or I pretended to; I can't remember. I guess a little of both, first one, then the other. Now when I look back, it seems as if I'd lived here like a beggar—just from hand to mouth. I've lived by doing tricks for you, Torvald. But that's the way you wanted it. It's a great sin what you and Papa did to me. You're to blame that nothing's become of me.

Helmer: Nora, how unfair and ungrateful you are! Haven't you been happy here?

Nora: No, never. I thought so—but I never have.

Helmer: Not....not happy!

Nora: No, only lighthearted. And you've always been so kind to me. But our home's been nothing but a playpen. I've been your doll-wife here, just as at home I was Papa's doll-child. And in turn the children have been my dolls. I thought it was fun when you played with me, just as they thought it fun when I played with them. That's been our marriage, Torvald.

Helmer: There's some truth in what you're saying....under all the raving exaggeration. But it'll all be different after this. Playtime's over; now for the schooling.

Nora: Whose schooling...mine or the children's?

Helmer: Both yours and the children's, dearest.

Nora: Oh, Torvald, you're not the man to teach me to be a good wife to you.

Helmer: And you can say that?

Nora: And I ...how am I equipped to bring up children?

Helmer: Nora!

Nora: didn't you say a moment ago that that was no job to trust me with?

Helmer: In a flare of temper! Why fasten on that?

Nora: Yes, but you were so very right. I'm not up to the job. There's another job I have to do first. I have to try to educate myself. You can't help me with that. I've got to do it alone. And that's why I'm leaving you now.

Helmer: [*jumping up*] What's that!?

Nora: I have to stand completely alone, if I'm ever going to discover myself and the world out there. So I can't go on living with you.

Helmer: Nora! Nora!

Nora: I want to leave right away. Kristine should put me up for the night..-

Helmer: you're insane! You've no right! I forbid you!

Nora: From hereon, there's no use forbidding me anything. I'll take with me whatever is mine. I don't want a thing from you, either now or later.

Helmer: What kind of madness is this?

Nora: Tomorrow I'm going home... I mean, home where I came from. It'll be easier up there to find something to do.

Helmer: Oh, you blind, incompetent child!

Nora: I must learn to be competent, Torvald.

Helmer: Abandon your home, your husband, your children! And you're not even thinking what people will say.

Nora: I can't be concerned about that. I only know how essential this is.

Helmer: Oh, it's outrageous. So you'll run out like this on your most sacred vows.

Nora: What do you think are my most sacred vows?

Helmer: And I have to tell you that! Aren't they your duties to your husband and children?

Nora: I have other duties equally sacred.

Helmer: That isn't true. What duties are they?

Nora: Duties to myself.

Helmer: Before all else, you're a wife and a mother.

Nora: I don't believe in that anymore. I believe that, before all else, I'm a human being, no less than you..or anyway, I ought to try to become one. I know the majority thinks you're right, Torvald, and plenty of books agree with you, too. But I can't go on believing what the majority says, or what's written in books. I have to think over these things myself and try to understand them.

Helmer: Why can't you understand your place in your own home? On a point like that, isn't there one everlasting guide you can turn to? Where's your religion?

Nora: Oh, Torvald, I'm really not sure what religion is.

Helmer: What..?

Nora: I only knew what the minister said when I was confirmed. He told me religion was this thing and that. When I get clear and away by myself, I'll go into that problem too. I'll see if what the minister said was right, or, in any case, if it's right for me.

Helmer: A young woman you age shouldn't talk like that. If religion can't move you, I can try to rouse your conscience. You do have some moral feeling? Or, tell me...has that gone too?

Nora: It's not easy to answer that, Torvald. I simply don't know. I'm all confused about these things. I just know I see them so differently from you. I found out, for one thing, that the law's not at all what I'd thought...but I can't get it through my head that the law is fair. A woman hasn't a right to protect her dying father or save her husband's life! I can't believe that.

Helmer: You talk like a child. You don't know anything of the world you live in.

Nora: No, I don't. But know I'll begin to learn for myself. I'll try to discover who's right, the world or I.

Helmer: Nora, you're sick; you've got a fever. I almost think you're out of your head.

Nora: I've never felt more clearheaded and sure in my life.

Helmer: And... clearheaded and sure...you're leaving your husband and children?

Nora: Yes.

Helmer: Then there's only one possible reason.

Nora: What?

Helmer: You no longer love me.

Nora: No. That's exactly it.

Helmer: Nora! You can't be serious!

Nora: Oh, this is so hard, Torvald... you've been so kind to me always. But I can't help it. I don't love you anymore.

Helmer: [*struggling for composure*] Are you also clearheaded and sure about that?

Nora: Yes, completely. That's why I can't go on staying here.

Helmer: Can you tell me what I did to lose your love?

Nora: Yes, I can't tell you. It was this evening when the miraculous thing didn't come... then I knew you weren't the man I'd imagined.

Helmer: Be more explicit; I don't follow you.

Nora: I've waited now so patiently eight long years.. for, my lord, I know miracles don't come every day. Then this crisis broke over me, and such a certainty filled me: *now* the miraculous event would occur. While Krogstad's letter was lying out there, I never for an instant dreamed that you could give in to his terms. I was so utterly sure you'd say to him: go on, tell your tale to the whole wide world. And when he'd done that..-

Helmer: Yes, what then? When I'd delivered my own wife into shame and disgrace..!

Nora: You're thinking I'd never accept such a sacrifice from you? No, of course not. But what good would my protests be against you? That was the miracle I was waiting for, in terror and hope. And to stave that off, I would have taken my life.

Helmer: I'd gladly work for you day and night, Nora, and take on pain and deprivation. But there's no one who gives up honor for love.

Nora: Millions of women have done just that.

Helmer: Oh, you think and talk like a silly child.

Nora: Perhaps, but you neither think nor talk like the man I could join myself to. When your big fright was over... and it wasn't from any threat against me, only for what might damage you... when all the danger was past, for you it was just as if nothing had happened. I was exactly the same, your little lark, your doll, that you'd have to handle with double care now that I'd turned out so brittle and frail. [*Gets up from table.*] Torvald... in that instant it dawned on me that for eight years I'd been living here with a stranger, and that I'd even conceived three children.. oh, I can't stand the thought of it! I could tear myself to bits.

Helmer: [*heavily*] I see. There's a gulf that's opened between us... that's clear. Oh, but Nora, can't we bridge It somehow?

Nora: The way I am now, I'm no wife for you.

Helmer: I have the strength to make myself over.

Nora: Maybe.. if your doll gets taken away.

Helmer: But to part! To part from you! No, Nora, I cant imagine it.

Nora: [*going out, right*] All the more reason why it has to be. [*she reenters with her coat and a small overnight bag, which she puts on a chair by the table.*]

Helmer: Nora, Nora not now! At least wait until tomorrow.

Nora: I can't spend the night in a stranger man's room.

Helmer: But couldn't we live here like brother and sister..-

Nora: You know very well how long that would last. [*throws her shawl about her*] Good-bye, Torvald. I won't look in on the children. I know they're in better hands than mine. The way I am now, I'm no use to them.

Helmer: But someday, Nora...someday...?

Nora: How can I tell? I haven't the least idea what'll become of me.

Helmer: But you're my wife, now and wherever you go.

Nora: Listen, Torvald... I've heard that when a wife deserts her husband's house just as I'm doing, then the law frees him from all responsibility. In any case, I'm freeing you from being responsible. Don't feel yourself bound, any more than I will. There has to be absolute freedom for us both. Here, take you ring back. Give me mine.

Helmer: That too?

Nora: That too.

Helmer: There it is.

Nora: good. Well, now it's all over, I'm putting the keys here. The maids know all about keeping up the house... better than I do. Tomorrow, after I've left town, Kristine will stop by to pack up everything that's mine from home. I'd like those things shipped up to me.

Helmer: Over! All over! Nora, won't you ever think about me?

Nora: I'm sure I'll think of you often, and about the children and the house here.

Helmer: May I write you?

Nora: No... never. You're not to do that.

Helmer: Oh, but let me send you...-

Nora: Nothing... nothing.

Helmer: Or help you if you need it.

Nora: No. I accept nothing from strangers.

Helmer: Nora... can I never be more than a stranger to you?

Nora: [*picking up the bag*] Ah, Torvald.... It would take the greatest miracle of all..-

Helmer: Tell me the greatest miracle!

Nora: You and I both would have to transform ourselves to the point that... oh, Torvald, I've stopped believing in miracles.

Helmer: But I'll believe. Tell me! Transform ourselves to the point that..?

Nora: That our living together could be a true marriage. [*she goes out down the hall*]

Helmer: [*sinks down on a chair by the door, face buried in his hands*] Nora!....nora..! [*looking about and rising*] Empty.....she's gone. [*a sudden hope leaps in him.*] The greatest miracle...-
-[*the door SLAMS shut*]-

the end.

herzleid

Be-wahret ein-ander



http

http://therapy.eics.com/rammstein/rammstein_e.htm

I AM POEM

Eric Harris

per. 6

10\30\95

I am a nice guy who hates when people open their pop can just a little.

I wonder what my soccer team will be like in the Spring.

I hear myself turning on the ignition of an F-15.

I see myself flying above everyone else.

I want to fly.

I am a nice guy who hates when people open their pop can just a little.

I pretend I am walking on the moon.

I feel that I will get straight A's again.

I touch the sky.

I worry that I will have a fire in my house.

I cry when I see or hear a dog die.

I am a nice guy who hates when people open their pop cans just a little.

I understand how to play soccer.

I say that a sport is something that you have to break a sweat in.

I dream that I am the only person on Earth.

I try to be as nice as I can.

I hope there isn't another O.J. trial.

I am a nice guy who hates when people open their pop cans just a little.

ID Software,

Hello, my name is REB. I have been playing your mega-hit Doom for about four and a half years now, and no matter what new games are invented and sold, I always have come back to doom2. The atmosphere and over-all feel of the game is still unmatched in my books. I have been creating my own levels and patches for about three years, and am still going strong. I have read all four books published by ID software about the Doom story. Fly and Arlene, and their adventures. I have noticed now that Quake is the new "story" in the ID books. However, I have been wondering for the past four years if a Doom 3 has even been considered by ID Software. Just imagine, all the old baddies and guns from doom, all the old textures and environments that made doom have such an impact, all of them on today's and tomorrow's newest gaming engines. Imps, humans, demons, spiders, all of them remade into an engine like the one used for quake 2. If it's a story line that kept you from making Doom 3, that is the least of your problems in my opinion. If the Doom novels aren't enough, or suitable, then I am positive there are hundreds of legitimate stories out there. Even I could come up with enough of a plot to make another Doom game. The plutonium pack and such were great, but they were still all on the same doom engine. I believe that the world of the space marine should be taken one step higher, or one lift higher. How many times have you wanted to look up and down, go underwater, see the "other" side of the doom eye, climb on top of the E1M8 star, and so many other things in doom? Maybe it is just a fantasy of mine, but then again, it is so very possible to make it real. If you need workers for doom levels or for graphics, I could even be a start. With my background and love for the game, I don't think there are many people at all in the world who know more about Doom than I do. I may not be able to make Quake 2 levels, but my doom levels could be one hell of an inspiration for new worlds. So, in conclusion, I have 3 questions...

- 1: Has it ever been considered that a Doom 3 could be made on an engine like or better than Quake's?
- 2: Is it possible to make even a Doom add-on for Quake, Quake 2, or other games of the kind?
- 3: How about a Doom movie?

Please reply as soon as possible, and if it is at all possible, try to have the creators of the original Doom and Doom 2 read this letter.

P.S. Would you like some screen shots of my latest doom levels, "Tier?" Maybe ID could use some of these levels...

---Loyal Doomer, REB.

Intvuw

WHAT WAS YOUR LIFE LIKE DURING THE GREAT DEPRESSION? DID YOUR FAMILY FEEL THE FULL IMPACT OF THOSE DIFFICULT TIMES?

Well, we had a home, had food on the table. Whenever mama made a loaf of bread it was a treat. I had nine people in my family and we lived in a little three room house. We always had a family gathering in the summer and went to the park to have picnics and play. most of them lived on farms so they had a lot of food because they raised it.

WHAT DID YOU AND YOUR FRIENDS DO FOR ENTERTAINMENT?

We never went anywhere, just played. We did go to the Saturday Matinees. Went to Sunday School and had picnics in the summer.

WHAT WERE YOUR FAVORITE MOVIES? FAVORITE ACTOR OR ACTRESS?

A western cowboy show, it was a serial. Tom Mix, Clark Gable, and Merna Loy.

CAN YOU REMEMBER THE NAMES OF ANY POPULAR SONGS?

Just Signin' in the rain.

WHAT KINDS OF DANCES DID YOU DO?

None, never was a dancer.

WHAT DID YOUR FAMILY DO FOR ENTERTAINMENT? DID YOU HAVE A RADIO? WHAT PROGRAMS DID YOU LISTEN TO?

Played cards, My parents went to square dances. Played dominos a lot. Yeah, we listened to Amis and Andy, and Ma Perkins.

WHAT WAS YOUR TOWN/CITY LIKE?

Just a normal town, nobody really had anything. Everyone that we knew didn't have a job, but a lot of the men were on W.P.A.

DID YOUR FAMILY OWN A CAR? IF SO, WHAT KIND? DO YOU REMEMBER THE PRICE OF GASOLINE?

Yeah, we had a model T. I sure don't.

DID YOU WALK TO SCHOOL? HOW BIG WAS IT? HOW MANY TEACHERS DID YOU HAVE?

Sure did. Pretty small. Just one, all day long.

WHAT SUBJECTS DID YOU STUDY?

Reading, writing, arithmetic, and some home EC.

DO YOU REMEMBER THE SOUP LINES?

Yes I do.

WHAT WAS YOUR GREATEST FEAR?

Worms, and snakes.

DO YOU RECALL ANY INTERNATIONAL EVENTS?

Just World War II, Hitler invading Europe.

HOW WERE TEENAGERS THEN DIFFERENT FROM TEENAGERS TODAY?

They didn't carry guns, they obeyed their parents, didn't talk back. Just more civilized.

DID YOU LIVE ANYWHERE ELSE BESIDES OKLAHOMA CITY DURING THE DEPRESSION?

Well in the summer of 1937 we moved to Denver.

DID YOU TAKE ANY FOREIGN LANGUAGES IN SCHOOL?

Nope, just English.

HOW LONG DID IT TAKE YOU TO WALK TO ELEMENTARY SCHOOL?
MIDDLE SCHOOL? HIGH SCHOOL?

About ten minutes, and about thirty for middle and high school.

IS THERE ANYTHING ELSE YOU WOULD LIKE TO ADD OR SHARE ABOUT THIS TIME IN YOUR LIFE?

I was just glad to get out of Oklahoma City. It was cold in the winter time. Denver was so much better.

Hi. I have a few things I really want to say but I never seem to be able to say them in person.

Even though I have only known you for a few weeks, and have hardly had any time to really *know* you, I would really like to get to know you much better. Actually when we worked together Monday night I wanted to ask you to just hang out for a while after work and maybe just talk. Like about that guy that you mentioned, the one that you met on AOL, or about work, school, people, anything. I just really wanted to spend some time with you. But, since your friend stopped by I assumed that you and her would be leaving together so I just left without saying anything. You see, I just hope that you feel the same. I am just kind of going on a hunch here, but I hope I'm right. I don't know if you like talking...or just to me... or what. From what I gather from people at work and by just being there, I see that almost every guy there flirts constantly with you or at least tries. And I try too, just to make you smile, but I have never been good at "flirting" or even just talking. I see that you are a very busy girl, and have a great family and nice friends, and you seem to like to talk about what your thinking, but so far, have been cut off short. You see, I have never understood why girls spend more time with guys who just look good and flirt a lot then with guys who actually have something intelligent to say and are a little "deeper" than most other guys. Oh well. I guess what I am trying to say is... if you have time in your life to just sit down, relax, and talk with a guy who cares a lot about you, and if you want to, let me know. Because I really want to get to know you, and who knows, maybe even "go out." If you don't.... just don't say anything. I'll understand, I'm used to it. Well, bye for now, maybe ill see you at work sometime this week. Please reply, or call, if you want to do something.

-Love Eric.



OH my gosh, I forgot to call you huh?

REB DoMiNe: yup.

I am so so sorry...let me explain...

REB DoMiNe: oh ok.

both [redacted] and one of my other friends came in tonight to ask me to go out and I told both of them no way because i wanted to go home and take a shower and just relax and I was thinking the whole shift that I was gonna call you and I just forgot after those two left around 8..I am sooo sorry :-)

REB DoMiNe: aah. doooont worry. i understand.

I feel so bad though, please don't be mad my mom is going to braid my hair real quick....I'll be back in like five

REB DoMiNe: oh dont worry. we gota do something though...you owwwwwe me nowwww=]

REB DoMiNe: ok. i should still be on

Ok I'm back

REB DoMiNe: ok cool.

REB DoMiNe: so were you very busy tonight at work?

yeah it was, but there were four of us

REB DoMiNe: so.....

REB DoMiNe: how is life treating you today?

pretty good, kinda sad because I started packing up my room

REB DoMiNe: aah. getting ready to leave huh.

yep, I have about three weeks to pack it all up though, I am leaving for most of August until right when I have to go up to CSU

REB DoMiNe: so wait, where are you going in august then?

to Wisconsin, I used to live there, I am going to stay with all of my relatives for two weeks to visit

REB DoMiNe: aah. thats great.

so what did you do today?

REB DoMiNe: ah not much. made a few calls and finally got my paycheck from tortilla wraps.

yeah I saw that sheet in the drawer, what was all of that about

REB DoMiNe: helped my mom pack too, she leaves for steamboat springs tomorrow morning

REB DoMiNe: well when [redacted] hired me, he never gave me the W-2 form to fill out, so i had to fill that out like around the beginning of this month and i couldnt get it to him until like monday...

REB DoMiNe: uh oh [redacted] just got on.

yeah I know, I had to work with him for a half an hour today

REB DoMiNe: harrrr har. =]

he was being lazy like usual and me and [redacted] both had to re-do what he attempted when he left that sucks

REB DoMiNe: I'm used to it with him, are you two friends at all?

REB DoMiNe: wellll. kind of yeah and kind of no.

REB DoMiNe: we have never even done anything together so not really.

REB DoMiNe: and from how i see he treats others...no not really.

that is what I though!

thought!

REB DoMiNe: =]

REB DoMiNe: what you doin tomorrow?

I am going to Idaho Springs with my family to meet some old friends from Kansas who are staying in the mountains. We are going to Beau Jo's pizza

I have to go to tattered cover in the morningq

REB DoMiNe: so uh, pretty un-eventful day huh. kind of boring i see...heh.

yep, pretty boring!

REB DoMiNe: heheh

what are you up to tomorrow

REB DoMiNe: i got a diversion meeting, i need to get my new medication, i work at blackjack, and my dad gets back from oklahoma tomorrow night so i need to drop my car off at SW plaza.

sorry about that, someone just called me

Kokain

REB DoMiNe: you're just to popular.=]
[REDACTED] oh please
REB DoMiNe: so are you lookin forward to CSU?
[REDACTED] I am really really excited, especially to get out of this house
REB DoMiNe: yeah
REB DoMiNe: lucky. i got another year still.
[REDACTED] hahaha! you going to college?
REB DoMiNe: mmm. not sure yet. probly not. maybe just a 2 year college or something small. major in computers graphics or something. but im almost positive not a 4year deal.
[REDACTED] I know your dream is to work at Tortilla Wraps for the rest of your life!
REB DoMiNe: oh yeah man...SSSShhhh dont tell though!!
[REDACTED] it will be our little secret!
REB DoMiNe: thanks! hehheh
REB DoMiNe: so what got you interested in.....communications was it?
[REDACTED] yeah and journalism,broadcast journalism or magazine journalism or advertising
REB DoMiNe: wow. you sure know what your doin huh. well that is very cool. good luck.
[REDACTED] well I hope I still like it when I get to college :-)
REB DoMiNe: yeah. i hear people change majors a lot once they are in college....not to get ya all nervous or anything..
[REDACTED] that has already made me nervous, thanks though!
REB DoMiNe: heh.
[REDACTED] what do you REALLY want to do then
REB DoMiNe: well what i REALLY want to do is go on a nice long vacation with someone for a few months. maybe costa rica or something. even a nice long road trip. but i just want to leave denver and all the damn people for a while. kind of take a break ya know?
[REDACTED] I suggest you do that then
REB DoMiNe: buuut. i guess something to do with computers. maybe games, maybe graphics, maybe internet. kind of wide area.
REB DoMiNe: mm. thanks.
[REDACTED] do you do any of that stuff now?
REB DoMiNe: yeah. i am pretty familiar with computers right now.
REB DoMiNe: especially computer games..heheh.
[REDACTED] you make games?
REB DoMiNe: oh no. but i play a few games in particular a lot.
[REDACTED] which games?
REB DoMiNe: mostly doom2. but i play quake and quake2 and duke nukem also.
REB DoMiNe: ever heard of them?
[REDACTED] nope, don't play computer games really
REB DoMiNe: yeah. gee your wierd, all the other girls i know are always on the computer!!! heheh. justkidin sorry!
REB DoMiNe: gawd jen.
[REDACTED] what?
REB DoMiNe: heh. nothing.
REB DoMiNe: but yeah. im usually doing something with doom2. but i love making graphics and stuff too.
[REDACTED] what kind of graphics?
REB DoMiNe: umm. hm. kind of hard to explain. i like very intense, deep, colorful, graphics. things that are out of a dream or something from deep space.
REB DoMiNe: things that make you go "awwhhhhhhhhhhh..... ..thats. ...aaaawwwesome"
[REDACTED] that sounds pretty cool
REB DoMiNe: arrg, hey, have you ever had a dream that you just cant stop thinking about? i had this wierd daydream today and i cant stop thinking about it.
[REDACTED] what was the dream?
REB DoMiNe: you really want to hear it?
[REDACTED] yeah

JC-001-026631

REB DoMiNe: alright. cool. gimme a sec to type it all out.

[REDACTED] ok

REB DoMiNe: ok, i am walking through this very deep forest at night time...i am wearing all this military gear like im a marine or something...there are these big flares going off way up high in the air and they are flying through the sky so there are shadows dancing all around. then i come out onto this beach that reminds me of one of those marine life posters with all the dolphins, whales, stars, oceans and everything. i look up into the stars and they are everywhere, like

REB DoMiNe: 10 times as many stars as you have ever seen. then i hear this voice saying "watch out for the flares and have a swell time!" and i get launched into space right into the stars.

[REDACTED] that is pretty crazy, I don't usually remember that much detail in my dreams, just bits and pieces

REB DoMiNe: same here. i cant belive i remembered all that. sounds kind of fun though..i guess

[REDACTED] that is a fun dream...I just get flashbacks during the day if I dream and that is all I think about

them

REB DoMiNe: yeah.

REB DoMiNe: hey, can i ask you a kind of personal, "deeper" question?

[REDACTED] sure

REB DoMiNe: what do you think about when you look at the sky at night, when theres no clouds out and you can see all the stars?

[REDACTED] I'm not sure if I should answer that

REB DoMiNe: ? what do you mean...

REB DoMiNe: im sorry if i said something wrong...forget i ever asked it.

[REDACTED] it's just that my mom keeps walking in here and I feel kinda weird when she sits next to me to talk it I am typing stuff like that

REB DoMiNe: oh. yeah i know how you feel. my mom does that too.

[REDACTED] my dad is out of town and I think she is lonely

REB DoMiNe: so i didnt like....offend or scare or anger you did i?

REB DoMiNe: thats so sad

[REDACTED] no, not at all

REB DoMiNe: phew. heh. sorry to put you in a kind of wierd position. you dont have to answer that if you dont want to.

[REDACTED] no worries

REB DoMiNe: coo

REB DoMiNe: hey, tell yer mom i said "hi" if shes still there!

[REDACTED] she is in the room right next to me, I told her

Kokain
(COCAIN)

[REDACTED]

[REDACTED]

A STUDY OF CHEMICAL EQUILIBRIUM

System 1: Solubility Equilibrium

Obtain approx 5ml of a saturated NaCl solution. Add drops of concentrated HCl until a change is noticed. Record your observations in the data table. Wash the solution down the drain with plenty of water.

System 2: Acid-Base Equilibrium

Obtain 4ml of distilled water. Add 2 drop of bromothymol blue as an indicator. Add .1 M NaOH one drop at a time until a color change occurs and record observations. Then neutralize the NaOH with the same concentration of HCl, adding a drop at a time until the color has changed. Dispose of the solution by washing it down the drain with plenty of water.

System 3: Iron (III) Thiocyanate Equilibrium

USE CAUTION! Place .2 M Fe(NO₃)₃ in a 100cm³ beaker. Record the color. Add 4ml of .1 KSCN and about 55ml of water to the solution and mix thoroughly. If the color is very dark, add more water. Separate this sol. Into three 4ml portions (using large test tubes). To one test tube, add 10-15 drops of Fe(NO₃)₃ (aq). To the second tube add 10-15 drops of KSCN sol. To the third tube add a few drops of 6 M NaOH. The Fe(OH)₃ that forms is nearly insoluble. Record observations of the three tubes. Dispose in the same manner as the previous systems.

Data table:

Stress on added or removed	Observations
Part A: Step 1: Cl	
Part B: Step 1: NaOH	
Part B: Step 2: HCl	
Part B: Step 3: NaOH	
Part C: Step 1: Fe(NO ₃) ₃	
Part C: Step 2: KSCN	
Part C: Step 3: NaOH	

Vitrifax: On Stanislaw Lem - Reviews of Lem's books

<http://world.std.com/~mmcirvin/vitrifaxrevs.html#returnfromthestars>

This web-page provides book reviews on all of Stanislaw Lem's books. Including Return From the Stars. It has a brief summary and explanation of the book and some information on the author and the translators.

Stanislaw Lem

<http://catalog.com/hopkins/lem/Lem.html>

This web-page is a collection of several letters and reviews on Stanislaw Lem's novels and short stories. There are brief descriptions on Return From the Stars, but if one would wish to know about other books Lem has written, then this is a very helpful site.

Planet BrainSex: Stanislaw Lem

<http://www.webcom.com/bsx/lem.html>

This particular web-page is about Stanislaw Lem. It tells about a lot of his earlier writings and shows some of his art that was used for a few of his own books. The site is very informative and easy to navigate on.

The Future of Humanity: A Lecture by Isaac Asimov

http://www.clark.net/pub/edseiler/WWW/future_of_humanity.html

This site is from a lecture given by the famous Russian author, Isaac Asimov. Isaac Asimov has written science fiction books just like Stanislaw Lem and I have found that their books share a few of the same thoughts and ideas. I believe that if one is interested in reading

novels by Lem or Asimov, this lecture can be a great start to the science fiction realm of literature. Asimov explains beliefs, ideas, philosophies and other interesting concepts that support science fiction.

The Existentialism Hideout

<http://www.geocities.com/Athens/6510/mainframe.htm>

Although existentialism is not a major theme in this novel, it does show up once or twice. Along with several other philosophies such as nihilism, anarchism, and a little bit of the belief called Angst. Since the novel deals with all sorts of mixtures of feelings and philosophies, I suggest exploring this page and other pages about the topics just mentioned to get a good view of some of the thoughts one might expect from Return From the Stars.

The science fiction novel, Return From the Stars by Stanislaw Lem, is a story of an astronaut named Hal Bregg who returns from a voyage that was ten years long for him and his crew and 150 years long for Earth. Society has drastically changed and he is haunted by memories of his dead crew members.

The story begins in an absolutely stunning description of a futuristic city as Hal Bregg wanders around in it. For hours he explores the new and amazing city, lost and confused by all the new customs, procedures, and strange people. He soon is confronted by a woman and Bregg tries to explain to her about his background. The woman is frightened by his size which is larger and more muscular than everyone else in the city and shocked that he is not "betriated," which is a process all humans and other evolved life forms go through at birth to nullify any violent impulses or harmful actions. Bregg then goes to a hotel and searches for any old friends or people that he might know or that might be able to explain what has happened to Earth.

After talking to a few doctors and scientists he discovers that all his work was for nothing. Almost half of his crew died for barely anything useful. Space exploration was deemed unimportant and wasteful. All sports and physical competitions ceased to exist because they were too dangerous. Any records set would only be broken by men or women that were not normal or were genetically enhanced, all human limits were reached and humans stopped striving for anything better. Remaining sports were padded to the point of which they were almost comical for Bregg to view. The human race lost all sense of romanticism and adventure.

Bregg is crushed by this news. He attempts to surround himself with whatever he can that remained from his time. He purchases books, (which were almost impossible to find since no books had been published for fifty years), and finds an antic car, which still was futuristic to him, and moves to a small town far away from any cities. While reading his books he discovers

that all cars, planes, trains, and any other forms of transportation have been deleted or changed so that absolutely no risk is involved for humans. Cars are replaced by "gleeders," which are described as flying black cigars. Several other ways of transportation are changed to be more efficient and safer.

Anything that poses a threat to humans is done by robots. Hal Bregg learns that robots are a major part of society. He learns that robots create, supervise, repair, and destroy themselves and no human intervention is required any more. He learns from a famous author and scientist that space travel is pointless since it takes so long to reach another solar system and get back that by the time the ship has returned, Earth has changed so dramatically that none of the information gathered is worth anything. Also, the author states that the odds of finding another advanced civilization are very small, and that even if one was found, by the time the ship returns to earth, the earth has changed drastically and then all the information that was gathered by the crew of the ship is useless because the alien civilization has changed too. Bregg is angered by his readings.

With the arrival of one of his crew mates, Olaf, he begins to feel better and not so alone. Olaf and Bregg talk of their time on the voyage and recall all that they have been through and what has happened to each other after they got back to Earth. Bregg is continuously haunted by memories and flashbacks of his dead crew mates, and tells the reader about how each one died and how he was involved in the death. After a love affair with a married woman who has mixed feelings for Hal but still cares for him, Hal tries to commit suicide in his car but is stopped by Eri, his lover. Hal leaves Eri and goes to see one of his other surviving crew mates, Thurber. After talking with Thurber for a while Hal learns of another space expedition that has been planned out in complete secrecy from the public. While deciding to leave Earth again or to stay

with his new wife Eri, Hal runs away into the mountains. There, he climbs to the top of a small mountain and looks over on the city and ponders about life, the human race, and the expedition, and finally decides to return to Eri.

Return From the Stars is an extremely well written novel even though it has been translated twice, Russian to German and German to English. The novel has some of the best descriptive scenes I have ever read, it possesses several very absorbing ways of thinking and philosophical views on life and humanity, and it has several greatly thought-out views on space travel and science.

In the beginning of the novel Stanislaw Lem describes an amazingly advanced city with all new forms of buildings, transportation, lighting, architecture, and several other things. The characters perception of this new world along with the vast and expressive description of this world adds up to place a brilliant picture into the reader's mind. I read the first twenty pages with out even flinching I was so engrossed. Lem creates a whole new world and transports the reader to this place. His use of descriptive words and analogies are fantastic, along with his ability to let the character wander in his own thoughts and react to the environment. The scenes in which Hal Bregg has flashbacks of his mission and when some of his crew members were killed are beautifully written also. His description of space, planets, and the ship are spectacular. His descriptions are so life-like and well written that sometimes I forget that I am reading a book and it is not real.

This book made me think. That is putting it lightly. Since the descriptions are so detailed and brilliant and it seems so real it made me think about what it would be like to be there and what the other characters are thinking and several other things. During the story, the main character, Hal Bregg, reads several articles and books on what he missed while he was away.

Some of the things that he reads are most interesting. He reads about a process called "betritization." This process was started about twenty years after Hal left Earth. What it does is it neutralizes strong impulses and nullifies immoral thoughts. It becomes simply impossible for one to imagine harming another. This process is also used on animals, too. At a certain time in the book Hal encounters two very large lions at night in a park. At first he is terrified but then he realizes that the lions will not attack and moves on. This has changed humanity all together, one article Hal observed had a meaningful quote in it; "they took the man out of man." That quote basically sums it up. Later, while Hal is at his resort, he begins to think about why people are even living anymore. He starts having thoughts about existentialism and nihilism. He tries to explain to himself why mankind has stopped to wonder or explore. Thoughts arise about what he has to live for and if he should do anything about his situation. Even with his wife Eri he feels like a strange foreigner. All these thoughts packed into one book provide one fantastic story.

When Hal Bregg left Earth, he believed that he was doing something great for mankind and that he was going to be remembered for all time. Throughout his missions he became more and more lonely and depressed. There were so many ways to die in space and the odds of one of those things happening was not that small, as he found out when about half of his crew died. One died in a probe sent out to gather data on a planet, and Hal waited all alone for his crew-mate for more than two days even though he knew there was almost no chance of him being found. Another died on a planetoid, and when Hal went down onto the surface to find him, he discovered that he was still alive and thought that he was in hell. Hal was shot in the stomach trying to take his crew-mate back to the main ship. Others died as well, and when Hal returned to Earth, he was hardly recognized for his efforts and deeds. No one cared anymore. Since space exploration was deemed useless, society only noticed that a large old man was now walking the

streets, and not a space hero that had returned from the stars. Since space travel can never be any faster than the speed of light, it was found that any attempt to find intelligent life forms was pointless. It was never scientifically proven in the story that faster-than-light travel existed. The only proof was that if an alien civilization discovered this technology of faster-than-light travel they would eventually come to our universe or within our range of vision, and since that has never happened in recorded history, it is highly unlikely that it exists at all. Also, since the time difference between the explorer and Earth was so great, it would be worthless to send out an expedition that would take 200 years to return from. These are just some of the views on space travel and humanity that I received from reading this book, but there are several more.

I recommend this book to anyone who likes to think deeper than the every-day things like soap operas and what is "hip" in fashion. If you have never read science fiction before, I recommend this book to you. It gives you a chance to escape this world and enter an entirely new one. Some of the stereotypes of science fiction repulse people away from any good worth while science fiction novels. Do not believe that all science fiction is Star Trek and Star Wars where every character has some long unpronounceable name from a planet far, far away and a time long, long ago. That would be like believing the only romantic thing every written was Romeo and Juliet. Out of all the great novels on the list I received to choose from, this one was not even on it. Another book by the same author called Solaris was, though. I read a few reviews on this book and found that it did not seem like I would enjoy it. The library had this book so I checked this out instead and my teacher okayed it. I strongly urge that this book be put on the list of great novels. I have also read Papillon and All Quite On the Western Front, and this book, in my mind, is the best of the three. So, in conclusion, I recommend this book to anyone who likes to read and think.

lyrx

Guilty by Gravity Kills

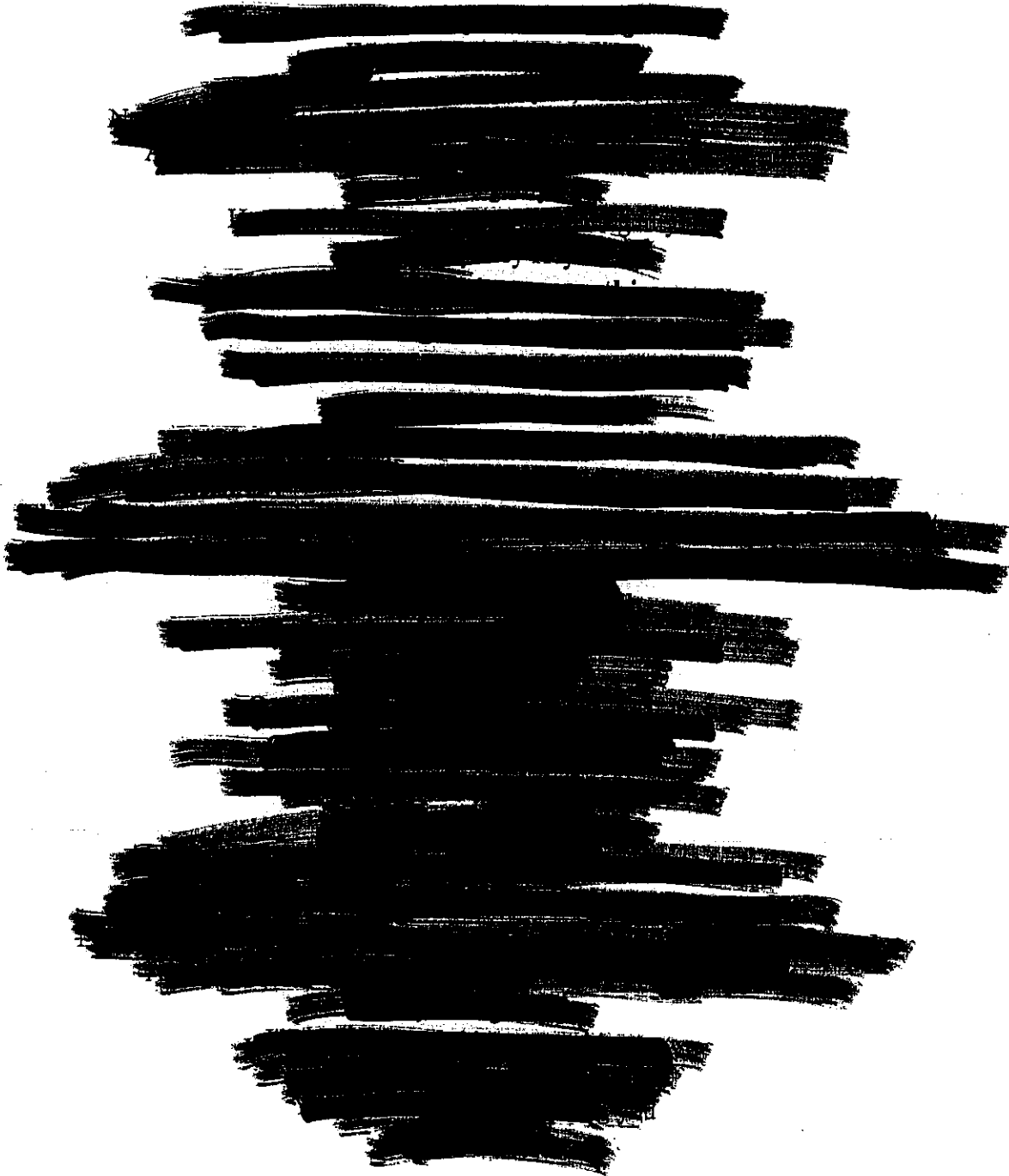

William Shakespeare uses the theme of nature in almost all of his writings. In the play, Macbeth, nature is strongly used for a bad or negative image. One strong example is the use of witches to show evil and darkness. Another example is the symbolism used when Banquo is murdered.

The witches are used throughout the play as symbols of bad nature. In I.i., I.iii., III.v., and in IV.i. the witches represent an evil force in nature. In the first scene of the play the witches are used to intrigue the audience and to show chaos. The quote, "When shall we three meet again/ In thunder, lightning, or in rain?" (I.i.1) means that the witches are unnatural since lightning and thunder represent unnatural events in nature. Those events tend to disturb peace and calmness in the world. "When the battle's lost and won," (I.i.4) is a paradox and is considered to be a disturbance of nature. The very next quote, "That will be ere the set of sun," (I.i.5) means that the witches will be meeting in the darkness. Darkness represents chaos or the unknown in nature, so the witches are used to show this. "Fair is foul, and foul is fair," I.i.12) is another use of paradoxical language. Therefore witches are a form of the unnatural, or of the bad in nature. Banquo describes the witches as being ugly and sinister. "You should be women,/ And yet your beards forbid me to interpret/ That you are so," (I.iii.46) means that the witches have beards and are very hideous. This shows that the witches are a disturbance to beauty and harmony. "Lesser than Macbeth, and greater," (I.iii.66) is another use of paradoxical language to show the witches are unnatural. The quote, "Fillet of a fenny snake,/ In the cauldron boil and bake;/ Eye of a newt, and toe of a frog..." (IV.i.12) is an example of how the witches deviate from good and how they are anomalies of nature. Macbeth recognizes the witches as evil also. "How now, you secret, black, and midnight hags?"

(IV.i.48) implies that the witches are representing darkness and evil. Nighttime and darkness are common symbols of things that are bad or unnatural. These quotations show that Shakespeare, using witches, exercised the use of nature as forces of evil in his play several times.

The murder of Banquo in the third act uses nature as a force of evil in several different ways. "The west yet glimmers with some streaks of day," (III.iii.8) is one such example. This quotation implies that the sun will soon be down and darkness will come over the land. Banquo is approaching into the murderers' trap and therefor darkness is being used as an evil setting. Since Banquo is murdered in the dark, darkness can be said to be evil. When Banquo says, "Give us a light there, ho!" (III.iii.12) he is calling to his murderers, which shows a bit of dramatic irony. The murders give him a false sense of security by showing him light to guide him into their trap. Therefor, in this case, light is used as an evil force of nature. Banquo practically helps call the murderers upon himself when he says, "It will be rain tonight," (III.iii.23) since rain is an unnatural event in nature. Banquo is about to be murdered when he says this, and rain is an unnatural event, so therefor rain is used for an evil force of nature. During the murder the one light is blown out, once again proving that darkness is an evil force of nature. The act of murdering is evil and definitely unnatural, and a murder in the dark is just that much more evil. Banquo's murder has several evil forces of nature surrounding it, such as darkness and nighttime. This proves that nature is used as a force of evil in the play.

Nature is a popular theme in many stories and plays. William Shakespeare is one master at using this theme to his advantage. In his play, Macbeth, nature is used as a force of evil. Throughout the play darkness, nighttime, witches, thunder, and lightning

are used as forces of evil. Witches represent the unnatural and chaotic side of nature along with pure evil. The murder of Banquo proves that darkness and nighttime are used as forces of evil and that bad things occur during these time periods or locations. The use of nature as a force of evil is definitely obvious in the play, Macbeth.

Medea Quote

The quote I have chosen from the play "Medea" is when Medea says, "no, like some yellow-eyed beast that has killed its hunters let me lie down on the hounds' bodies and the broken spears." This quote shows that Medea wants to die fighting, be brave and courageous and not let her hunters take her without a struggle. This pertains to today's society because generally people who are in trouble or on the run think or want to think that they will not go out without a fight, and some people believe that they will be taken quietly and calmly, and not struggle at all. In the play, it is what the Greek women want Medea to do, be taken without a struggle, but she refuses.

Some people in today's society believe or want to believe that they are tough and strong. They think that they will not go out without a fight and can be brave in the face of danger and apprehension. Then again, there are people who say and do go out with a fight and aren't captured easily, proving they are who they say. There are also people who do not fight or struggle when captured. Euripides wants the readers to believe that Medea is as strong as she says and that she will put up a fight in the face of danger, which in my views she would. There are several different types of people in today's world as there was in ancient Greece. Medea is the type of person that is tough and hard as "stone" as she is often referred to as. The Greek women are the types of people who are more calm and have less of a will to be free or stand up. It seems like today many people are like that too, and that the people who are like Medea are rare or hard to find. Which is what the case is in the play. Medea is a foreigner to Greece and is different from all the people there.

So in conclusion, Euripides' play "Medea" has several themes and ideas that still pertain to today's society. One example is the quote by Medea, "no, like some yellow-eyed beast that has killed its hunters let me lie down on the hounds' bodies and the broken spears." Medea is portrayed as the type of person that would not be captured without a fight and would make a stand. The Greek women in the play tell her not to stand up, therefore they are the kind of people that would not fight or be courageous. This is like today's society because it seems like there are a few people like Medea and the majority of the people are like the Greek women.

As I walked through the broken door entrance to the final military installation, I realized that this hellish experience was almost over. The invasion was stopped, all of the aliens were dead, and whatever wasn't dead was waiting for me ahead. While I was leaning against a granite wall in a large calmly lit room, I scanned over the dozens of marine bodies that scattered the floor in front of me. A last, futile, stand that wasn't enough to ward off the alien attacks. Bullet shells sprinkled the floor, on top of the carpet of blood. I must go on, to fight whatever waited ahead, I am the only one left on humanity's side of the battle. The bright room ahead suggested that I wouldn't have anywhere to hide once I showed myself. I almost laid down beside my fallen comrades and just went to sleep, as some of them appeared to be. But that would mean that they bad guys would win, and I just could not allow that to happen. So I gathered up all the bullets and superior firepower I could scavenge off of the dead soldiers, or what was left of them, and prepared myself for the last battle.

As I entered the last military base on the moon, I came upon a hellish sight. Bodies of my former marine buddies were scattered across the stone floor. The deathly dark glow of light from above provided barely enough light to notice the blood and flesh splattered on the large slabs of granite that passed for walls. The platoon had tried to barricade themselves in, but with the alien fire coming through two gigantic windows and with a blitzkrieg of monsters in the small doorway between the windows, the marines couldn't hold them. Arms, legs, and heads were tossed about as if a small child turned on a blender with no lid in the middle of the room. Some were burnt off, some torn, some eaten. Even though the mass of alien bodies outside the room was at least 10 times the marines', they still fell. I must be crazy to fight this war; I must be out of my battered mind. How could one soldier stop all of these monsters? There must be some way out of here that doesn't involve firepower. It is just too much, all the death and destruction. It's pointless, there's no way, no way at all. I can't fight anymore-let them take Earth-I'll stay here on my little moon-along with my squad of dead soldiers.

THE HANGOUT

In the small, rural town of Phillipsburg on the border of a large, tall forest, a group of 6th grade boys are hanging out near a small shopping plaza. Dave, a five foot seven blond boy was talking with his two best friends, Danny and Bill.

“Hey Danny, uh, me and Bill were wonderin’ if uh, if you wanna go out in the woods after school and look for a new hangout place?”

“Yeah, I guess. I mean these guys are fine, but I think we should find a hangout place just for us three,” said Danny quietly.

“I know what ya mean, I’m getting sick of John and his little sidekick Joe. It’s like they’re joined at the hip almost.” I whispered. I did not want John and Joe to hear this little conversation.

Danny was a short kid, about five feet. He has the most wicked eyes I have ever seen. Maybe like some sort of a demons’ eyes or something. His short buzz-cut made him look like a mini-marine with glasses. Bill, on the other hand, was about my height and is pretty large. His hair-cut is as if he stuck his head out of a car window for a while and then added a lot of hair spray. And out of the two of them, Bill is the brave one, not to bright but brave.

"Oh, Danny, bring your firecrackers in case someone from the gang follows us. If we even find anything," said Bill, the pyro in the group.

The next day we left our houses and went out into the tall forest to look for a new hangout place. Some of the trees in there must be at least a hundred feet tall. The large, almost majestic trees swayed in the light spring breeze. As we traveled through this giant forest we came to a stop at the largest, fattest, most oddly shaped oak tree we have ever seen. Its' snake like arms twisted and pushed through all the other trees surrounding it. And they were surrounding the tree, almost as if protecting it from some monster. When we saw this tree and its branches running around everywhere Danny said, "I think we just found a new hangout place."

We had. We used the low branches to sit and do homework on and all the others to mess around on. The tallest branches are reserved for a kind of a lookout tower for any of the old gang guys coming to take what is ours. After about ninety minutes of messing around we went home.

The next day at school we were talking about whether or not we should put any traps around the oak, that's what we call the place, for any intruders.

"I think we should because John and his gang walk close to there every day and they might hear us one day and try to takeover our place." I said to Bill and Danny.

"Yeah but we might trip on them ourselves, ya know," said the always safe Danny boy. "And besides, they would probably see all of the traps."

"Then we cover them up good and make a map of where they are or something." Bill said.

"Make a map of where what are?" Asked John, who we didn't even see walk by.

"Nothing John, we were just talking about our homework," said Danny, as he fought to come up with another excuse.

"Liar. I heard about the new hangout that you guys found and starting tomorrow, we're gonna hangout there too, because that place sounds pretty cool," said John confidently.

"I don't think so John, that is our place, not yours and only we hang out there. And we will defend it if you try and go there." I remarked.

"Fine then, we'll fight you for it! And were gonna kick your butts." And then he left.

"Great man, just great, were gonna be buried at the oak if we don't let them go there!" Danny said as he panicked.

"I don't think so Danny boy" I said, thinking of a way to defend our, well our fortress now.

That day after school we set up trip wires, ditches, and a covered river all around the front of the oak. The thick, twisting branches of the oak tree and the smaller siblings around it formed an organic barricade and wall. We even brought in our new paint ball guns. With four buckets filled with up with paint balls and a small box of assorted fireworks, we were ready to kick some butt!

The next day at school we could only think about the fight that afternoon. I was thinking that we would win in the end. But I heard that they had some paint ball guns of their own and that all of Johns friends were coming. The feeling before the battle was one I never felt before. It was a mix between anticipation, hope, fear, and wonder. If we

didn't win, we would be laughed at for the rest of sixth grade and John would have his buddies pick on us every second.

After school we went to the oak and began to prepare for battle. About fifteen minutes later we saw them coming. We slapped down our protective visors and put on our masks for the paint balls. We fired a warning rocket in the air above them. They responded with a barrage of red and yellow paint balls that splattered all around us. Bill and Danny were at the bottom of the tree and I was at the top. I shouted "you asked for it!!!" and began to fire off a couple of paint balls.

Bill screamed out "Let's rock!" and fired about fifty balls out of his fully automatic paint ball gun.

Danny and I both fired a twelve pack of bottle rockets out of our little guns made to fire the rockets. We made them out of a foot long pipe and a little wooden handle. A couple of them must have exploded close to them because we heard a couple "OW!"s and "AAAH!"s. As I fired more balls of paint I saw Joe trip over a trip wire and fall into our little man-made pond, which was obscured from his vision by leaves at the time. He was so embarrassed of his unexpected swim that he began to get up and run away. I fired about twenty balls that hit him as he scurried away.

After about ten minutes of steady barrages of paint balls and explosions from our pyrotechnics the only person that was left was John and a friend of his, Matt. Matt was only about ten meters from the closest branch of the oak tree when I grabbed three strips of two hundred firecrackers. I lit one after another and tossed them at him. After he ran away we had to deal with John. He had just got onto the first tree branch when Danny popped up and stared at him with those animal like eyes. John seemed hypnotized so me

and Bill surrounded him and blasted his face with paint balls. Danny then launched a potato from our secret weapon, the potato gun and it hit him in the stomach and he fell off the branch, staggered up, and started to run. As he ran, we unloaded the rest of our paint balls on them, about sixty bottle rockets and about five potatoes from our potato gun.

We had won. The oak tree was ours for the keeping. The injuries were light, Bill was hit in the shoulder with a bottle rocket and Danny was shot in the left forearm with what appeared to be a pellet. Someone must have had a pellet gun. On the contrast, I was bruised in the shoulder when a broken branch fell on it. All of us were bruised and dripping with paint except Danny, who had only one hit in the foot.

When we went out into the battlefield we found six paint ball guns covered in green paint, which was the color of Danny's paint balls. Another gun had a bottle rocket stuck in the barrel, one of Danny's rockets.

"Gees Danny, you went berserk here. You must have hit these guns ten times each," I said in amazement.

"Yeah I guess I did lose it a little."

After that day we went to that enormous oak tree every afternoon. We never had to defend it again and John became the school dork. The hangout was ours.

Eric Harris
period 4, 9/18/96

Native Americans were very diverse and complex people. However, they had many things in common. They believed in many Gods, and they also had generally the same ideas about how the world was created. Indians also used natural resources and animals for almost everything.

One generalization for many Native American cultures is the belief in God and the creation of Earth by him. Many cultures believed in more than one God. "O our mother the Earth, O our father the Sky" is one example. The Indians ideas' about how the Earth was created involved many of the same things. Like animals helping humans and lots of water or great floods.

Indian cultures used natural resources for almost everything. They used trees for their homes and weapons. They used plants and shrubs for many medicines and food. The Indians also respected nature. In almost every culture there would never be a wasted or unused animal corpse. They all used the entire parts of every animal to help them. Most Indian tribes never killed just to kill. The Indian tribes would use animals for clothing, food, weapons, and many other everyday uses.

Native Americans were very different and complex people. Even though there were hundreds of different tribes, they shared many of the same ideas and beliefs. Such

as their belief in more than one God, and that God created the Earth. Also the Indians used animals and natural resources for almost all their needs.

Eric Harris
period 4, 9/18/96

The leaders of many Indian nations and the concept of the league of nations have a large relevance in today's society. Leaders had to have many important traits. The league of nations needed peace, not war. These ideas still live today.

The Leaders of the Native American tribes needed to have many special traits in order to be a good leader. Leaders needed to be immune to anger, criticism, and never think about fear or anger. "...For you will be proof against anger, offensive action, and criticism." Leaders needed to be totally against any offensive actions. "Neither anger nor fear shall find lodgment in your mind." Anger and fear should never affect leaders. The leaders of Native American tribes needed to have many traits. Anger and offensive actions could not be a part of a true Indian chief.

The concept of the league of nations was to have many Indian nations unite in peace and to have a main government for all the nations. The league of nations did not believe in war. "...Now uproot the tallest pine tree and into the cavity thereby made we cast all the weapons of war." This means they wished to get rid of all the weapons of war. "We bury them (weapons of war) from sight forever and plant again the Tree." The league of nations wanted to forget about war and dispose of all the weapons. The league of nations wanted to join many nations into 1 main nation. "If any man of any nation shall show a desire to obey the laws of the Great peace. They shall trace the roots to their

source, and they shall be welcomed to take shelter beneath the Tree of the Long Leaves.” This shows that all nations could join in and be part of the league of nations. “The smoke of the confederate council fire shall pierce the sky so that all nations may discover the central council fire of that Great Peace.” They wanted all nations to join their confederation. The league of nations generally wanted many Indian nations to join in peace and stop the wars.

Today’s leaders and toadies United Nations are generally the same as the Native American leaders and the league of nations. Today’s leaders are almost the same as the Indian leaders. Our leaders can not be affected by fear or anger. They are compassionate to their people, and they do not let criticism or offensive action judge their decisions. Both today’s and the Indian leaders view the present AND future generations. The league of nations and today’s United Nations are very similar. We both try to stop war, and make peace with all nations. We also use the Indians’ idea of letting all nations join in. Our present ideas about leadership and uniting nations are very much the same with the Native Americans ideas.

Native American leaders and the concept of the league of nations are very similar to today’s united governments and leaders. Many of the Indians’ ideas about what traits leaders should have are present in today’s leaders. Also, the Indians ideas about the league of nations and our United Nations are very similar. Which means the Indians ideas have a great effect on today’s society.

JC-001-026658

Nixon

Singapore.

By: Eric Harris

period 4

Mr. Webb

10/6/97

JC-001-026659

"No gum, nope. We can't chew any gum in Singapore," said Nixon as we talked about his hometown of Singapore. Nixon is 28 years old and is visiting the United States for training in his job at Gates Rubber Co. He wanted me to use his first name in this report instead of using his entire name, plus he said it was too hard to pronounce in English anyway! As he was explaining his hometown to me, I realized that Singapore is a lot like the United States. Business, sports, and recreation are all very similar. Although, religion and customs vary quite extensively. Geographically Singapore is very small, approximately 616 square kilometers. Its inhabitants refer to it as a "island-city" since the city itself covers most of the island.

Singapore has a tropical climate so the sports are mostly similar to American sports. Nixon has played soccer and softball in his hometown. Rugby, badminton, and basketball are also offered. "Soccer is most popular, softball is popular too, though," Nixon explains as he remembers his younger years. His city is fairly up to date as far as electronics and businesses are concerned. Their computers are basically the same speed as ours, and the car systems are fairly recent. Nixon himself does own a computer. Even though the business he works for provides an e-mail address, so he can be in touch with the rest of the world at almost any place. When asked what he did for fun in Singapore Nixon replied, "We shop, or go to bars." The night life in Singapore is very much like America. There are bars, theaters, movies, and malls to go to after work or school is over. Compared to Colorado, Singapore does not have skiing, snowboarding, or hockey. On the other hand, one can go on walks or go rock climbing on the island. Nixon does not own a car or even a bike, instead he uses the vast subway system in Singapore. The price of a car in Singapore is about three times the cost in America, plus there are many taxes and expenses that add to the overall cost.

JC-001-026660

Singapore has many customs and traditions that might seem unusual to Americans. Even though Nixon is the first son in his family, he is still pursuing his job. Usually in his city the first born stays with the parents after school is over. Nixon once replied, "maybe my sister would do that for me," when asked if he would have to go back soon and stay with his mother and father. The main religion in Singapore is Buddhism. Muslim, Christianity, and several others also play a role in his culture. Nixon is Buddhist, and believes in the ways of Buddha. Nixon briefly explained the beliefs and thoughts of his religion. One of the main points he made on Buddhism was, "the ones who follow the religion closely do not believe in having material possessions. Instead they spend their time meditating and thinking of peace and tranquillity." His hometown celebrates many holidays for many religions. Such as Christmas or Singapore's independence day. The government in Singapore is a republic. The laws are somewhat similar to America. Although, some of the punishments are different. Some of the laws that are very different from America are that one can not chew gum, consume tobacco products, or drive under 16 years of age. The legal limit for alcohol is 18 years old. To buy an apartment in the city, one must be married or scheduled to be married within two years. Then, after the apartment is signed over, the couple must stay married for five years in order to keep their home. This is why most young adults live with their parents. As of right now, Singapore does not have a limit on the amount of children one couple can have. In the past, the law has been as low as one child per couple because the city was getting too crowded. When Nixon was asked if he was married he replied, "not yet, no. No interest in marriage yet." There are many limits on seeing movies. Movies with violence or sex in them are usually restricted to persons under 21. Pornography is completely outlawed in Singapore, along with fireworks. The Internet services on Singapore are monitored so people do not receive illegal files or information. The food in Singapore is mainly

very healthy. There are traditional Chinese and Asian dishes along with the ever-popular McDonalds restaurants. The average work day is the same as the American work day. Usually a person will stay with the same company for their entire career. If one is fired or quits, they are hated or shunned. So when Nixon was asked if he would stay with the Gates Rubber Company he said, "I sure hope so!" One thing Nixon noticed about American people is that they are much more open minded and they speak their mind more than he is used to. Most of the citizens in Singapore are quite and keep to themselves. Americans, on the other hand, are free to do and say what they want, and according to Nixon, we do it all the time! He is surprised how much the people in America like to be individualists. "Some of the people here might even be arrested in Singapore for some of the things they do in public," said Nixon as we talked of the restrictions in his city.

The island of Singapore is located on the equator and around the tip of Malaysia. Which is south of Thailand. The climate is tropical, so there are hot summers and mild winters. Nixon knew a great deal of information on his hometown, so that led me to believe that he was proud to be from there. Singapore is not very much of an agricultural economy, rather more of business and electronics. Since the island is near two major bodies of water, it is known to have many busy harbors. When asked if he has ever been on a boat though, Nixon said, "No, I do not like boats too much." He gets around this little problem by flying to wherever he needs to go. The island does have an airport, and it is used quite often because of all the business traveling. Nixon said he would be returning to his home in early October. "I do like America, but I still think Singapore is better," said Nixon proudly.

In conclusion, Singapore is a very interesting place. From my new friend Nixon, I learned that his culture is very similar to Americas. We have many of the same sports,

businesses, and entertainment methods. The religions and customs vary greatly between our two nations, but the moral values and legal standards are basically the same. Nixon is a good friend, and a very intelligent man. I enjoyed talking with him and I hope he will return to "our little country" soon. In the few hours I spent with him and his roommates, I learned that people from all over the world are all interested in the American ways of living and thinking, but it seems that we ourselves sometimes are not as interested in them. I believe that we should spend more time learning about other nations instead of being contempt with our own.

Singapore.

By: Eric Harris

period 4

Mr. Webb

10/6/97

"No gum, nope. We can't chew any gum in Singapore," said Nixon as we talked about his hometown of Singapore. Nixon is 28 years old and is visiting the United States for training in

JC-001-026664

his job at Gates Rubber Co. He wanted me to use his first name in this report instead of using his entire name, plus he said it was too hard to pronounce in English anyway! As he was explaining his hometown to me, I realized that Singapore is a lot like the United States. Business, sports, and recreation are all very similar. Although, religion and customs vary quite extensively. Geographically Singapore is very small, approximately 616 square kilometers. Its inhabitants refer to it as a "island-city" since the city itself covers most of the island.

Singapore has a tropical climate so the sports are mostly similar to American sports. Nixon has played soccer and softball in his hometown. Rugby, badminton, and basketball are also offered. "Soccer is most popular, softball is popular too, though," Nixon explains as he remembers his younger years. His city is fairly up to date as far as electronics and businesses are concerned. Their computers are basically the same speed as ours, and the car systems are fairly recent. Nixon himself does own a computer. Even though the business he works for provides an e-mail address, so he can be in touch with the rest of the world at almost any place. When asked what he did for fun in Singapore Nixon replied, "We shop, or go to bars." The night life in Singapore is very much like America. There are bars, theaters, movies, and malls to go to after work or school is over. Compared to Colorado, Singapore does not have skiing, snowboarding, or hockey. On the other hand, one can go on walks or go rock climbing on the island. Nixon does not own a car or even a bike, instead he uses the vast subway system in Singapore. The price of a car in Singapore is about three times the cost in America, plus there are many taxes and expenses that add to the overall cost.

Singapore has many customs and traditions that might seem unusual to Americans. Even though Nixon is the first son in his family, he is still pursuing his job. Usually in his city the first born stays with the parents after school is over. Nixon once replied, "maybe my sister would do

that for me," when asked if he would have to go back soon and stay with his mother and father. The main religion in Singapore is Buddhism. Muslim, Christianity, and several others also play a role in his culture. Nixon is Buddhist, and believes in the ways of Buddha. Nixon briefly explained the beliefs and thoughts of his religion. One of the main points he made on Buddhism was, "the ones who follow the religion closely do not believe in having material possessions. Instead they spend their time meditating and thinking of peace and tranquillity." His hometown celebrates many holidays for many religions. Such as Christmas or Singapore's independence day. The government in Singapore is a republic. The laws are somewhat similar to America. Although, some of the punishments are different. Some of the laws that are very different from America are that one can not chew gum, consume tobacco products, or drive under 16 years of age. The legal limit for alcohol is 18 years old. To buy an apartment in the city, one must be married or scheduled to be married within two years. Then, after the apartment is signed over, the couple must stay married for five years in order to keep their home. This is why most young adults live with their parents. As of right now, Singapore does not have a limit on the amount of children one couple can have. In the past, the law has been as low as one child per couple because the city was getting too crowded. When Nixon was asked if he was married he replied, "not yet, no. No interest in marriage yet." There are many limits on seeing movies. Movies with violence or sex in them are usually restricted to persons under 21. Pornography is completely outlawed in Singapore, along with fireworks. The Internet services on Singapore are monitored so people do not receive illegal files or information. The food in Singapore is mainly very healthy. There are traditional Chinese and Asian dishes along with the ever-popular McDonalds restaurants. The average work day is the same as the American work day. Usually a person will stay with the same company for their entire career. If one is fired or quits, they are

hated or shunned. So when Nixon was asked if he would stay with the Gates Rubber Company he said, "I sure hope so!" One thing Nixon noticed about American people is that they are much more open minded and they speak their mind more than he is used to. Most of the citizens in Singapore are quite and keep to themselves. Americans, on the other hand, are free to do and say what they want, and according to Nixon, we do it all the time! He is surprised how much the people in America like to be individualists. "Some of the people here might even be arrested in Singapore for some of the things they do in public," said Nixon as we talked of the restrictions in his city.

The island of Singapore is located on the equator and around the tip of Malaysia. Which is south of Thailand. The climate is tropical, so there are hot summers and mild winters. Nixon knew a great deal of information on his hometown, so that led me to believe that he was proud to be from there. Singapore is not very much of an agricultural economy, rather more of business and electronics. Since the island is near two major bodies of water, it is known to have many busy harbors. When asked if he has ever been on a boat though, Nixon said, "No, I do not like boats too much." He gets around this little problem by flying to wherever he needs to go. The island does have an airport, and it is used quite often because of all the business traveling. Nixon said he would be returning to his home in early October. "I do like America, but I still think Singapore is better," said Nixon proudly.

In conclusion, Singapore is a very interesting place. From my new friend Nixon, I learned that his culture is very similar to Americas. We have many of the same sports, businesses, and entertainment methods. The religions and customs vary greatly between our two nations, but the moral values and legal standards are basically the same. Nixon is a good friend, and a very intelligent man. I enjoyed talking with him and I hope he will return to "our little

country" soon. In the few hours I spent with him and his roommates, I learned that people from all over the world are all interested in the American ways of living and thinking, but it seems that we ourselves sometimes are not as interested in them. I believe that we should spend more time learning about other nations instead of being contempt with our own.

JC-001-026668

Singapore.

By: Eric Harris

period 4

Mr. Webb

10/6/97

“No gum, nope. We can’t chew any gum in Singapore,” said Nixon as we talked about his hometown of Singapore. Nixon is 28 years old and is visiting the United States for training in

his job at Gates Rubber Co. He wanted me to use his first name in this report instead of using his entire name, plus he said it was too hard to pronounce in English anyway! As he was explaining his hometown to me, I realized that Singapore is a lot like the United States. Business, sports, and recreation are all very similar. Although, religion and customs vary quite extensively. Geographically Singapore is very small, approximately 616 square kilometers. Its inhabitants refer to it as a "island-city" since the city itself covers most of the island.

Singapore has a tropical climate so the sports are mostly similar to American sports. Nixon has played soccer and softball in his hometown. Rugby, badminton, and basketball are also offered. "Soccer is most popular, softball is popular too, though," Nixon explains as he remembers his younger years. His city is fairly up to date as far as electronics and businesses are concerned. Their computers are basically the same speed as ours, and the car systems are fairly recent. Nixon himself does own a computer. Even though the business he works for provides an e-mail address, so he can be in touch with the rest of the world at almost any place. When asked what he did for fun in Singapore Nixon replied, "We shop, or go to bars." The night life in Singapore is very much like America. There are bars, theaters, movies, and malls to go to after work or school is over. Compared to Colorado, Singapore does not have skiing, snowboarding, or hockey. On the other hand, one can go on walks or go rock climbing on the island. Nixon does not own a car or even a bike, instead he uses the vast subway system in Singapore. The price of a car in Singapore is about three times the cost in America, plus there are many taxes and expenses that add to the overall cost.

Singapore has many customs and traditions that might seem unusual to Americans. Even though Nixon is the first son in his family, he is still pursuing his job. Usually in his city the first born stays with the parents after school is over. Nixon once replied, "maybe my sister would do

that for me,” when asked if he would have to go back soon and stay with his mother and father. The main religion in Singapore is Buddhism. Muslim, Christianity, and several others also play a role in his culture. Nixon is Buddhist, and believes in the ways of Buddha. Nixon briefly explained the beliefs and thoughts of his religion. One of the main points he made on Buddhism was, “the ones who follow the religion closely do not believe in having material possessions. Instead they spend their time meditating and thinking of peace and tranquillity.” His hometown celebrates many holidays for many religions. Such as Christmas or Singapore’s independence day. The government in Singapore is a republic. The laws are somewhat similar to America. Although, some of the punishments are different. Some of the laws that are very different from America are that one can not chew gum, consume tobacco products, or drive under 16 years of age. The legal limit for alcohol is 18 years old. To buy an apartment in the city, one must be married or scheduled to be married within two years. Then, after the apartment is signed over, the couple must stay married for five years in order to keep their home. This is why most young adults live with their parents. As of right now, Singapore does not have a limit on the amount of children one couple can have. In the past, the law has been as low as one child per couple because the city was getting too crowded. When Nixon was asked if he was married he replied, “not yet, no. No interest in marriage yet.” There are many limits on seeing movies. Movies with violence or sex in them are usually restricted to persons under 21. Pornography is completely outlawed in Singapore, along with fireworks. The Internet services on Singapore are monitored so people do not receive illegal files or information. The food in Singapore is mainly very healthy. There are traditional Chinese and Asian dishes along with the ever-popular Mc Donalds restaurants. The average work day is the same as the American work day. Usually a person will stay with the same company for their entire career. If one is fired or quits, they are

hated or shunned. So when Nixon was asked if he would stay with the Gates Rubber Company he said, "I sure hope so!" One thing Nixon noticed about American people is that they are much more open minded and they speak their mind more than he is used to. Most of the citizens in Singapore are quite and keep to themselves. Americans, on the other hand, are free to do and say what they want, and according to Nixon, we do it all the time! He is surprised how much the people in America like to be individualists. "Some of the people here might even be arrested in Singapore for some of the things they do in public," said Nixon as we talked of the restrictions in his city.

The island of Singapore is located on the equator and around the tip of Malaysia. Which is south of Thailand. The climate is tropical, so there are hot summers and mild winters. Nixon knew a great deal of information on his hometown, so that led me to believe that he was proud to be from there. Singapore is not very much of an agricultural economy, rather more of business and electronics. Since the island is near two major bodies of water, it is known to have many busy harbors. When asked if he has ever been on a boat though, Nixon said, "No, I do not like boats too much." He gets around this little problem by flying to wherever he needs to go. The island does have an airport, and it is used quite often because of all the business traveling. Nixon said he would be returning to his home in early October. "I do like America, but I still think Singapore is better," said Nixon proudly.

In conclusion, Singapore is a very interesting place. From my new friend Nixon, I learned that his culture is very similar to Americas. We have many of the same sports, businesses, and entertainment methods. The religions and customs vary greatly between our two nations, but the moral values and legal standards are basically the same. Nixon is a good friend, and a very intelligent man. I enjoyed talking with him and I hope he will return to "our little

country" soon. In the few hours I spent with him and his roommates, I learned that people from all over the world are all interested in the American ways of living and thinking, but it seems that we ourselves sometimes are not as interested in them. I believe that we should spend more time learning about other nations instead of being contempt with our own.

JC-001-026673

NARRATIVE POEM

Eric Harris
per. 6 11/2

The big game has finally come tonight.
The Columbine Rebels versus the Chatfield Chargers in football.
The Chargers are filled with fright,
For the Rebels will beat them like a rag-doll.

Coach Lee of the Chargers was a nervous guy.
But when the kickoff came, and the Rebels began to boast,
Coach Lee almost died,
Because the football had landed beside his own goal post.

During the first quarter,
Rebel quarterback [REDACTED] threw three touchdown passes.
Plus the Rebel defense was like a mortar,
And the Charger offense piled up in masses.

The second and third quarter were boring.
There was very little scoring.
But when the two-minute warning was reached,
The Rebel defense was breached.

The Chargers had scored a touchdown,
Which gave the Rebel defense a frown.
Although the score was twenty-one to seven,
Coach Lee felt that he was in heaven.

The game is exciting now,
Coach Lee and the Chargers scored two more touchdowns.
But it appears that [REDACTED] is coming in.
And he is as mad as sin.

[REDACTED] throws a touchdown pass right away,
And now the Chargers don't want to play.
For [REDACTED] is here to stay,
And the Chargers are dead in this fray.

[REDACTED] is now part of Rebel Fame.
The final score was forty-nine to seven in that game.
Coach Lee walked off the field that day staring at his feet and the pebbles,

Too depressed to look up because of his defeat by the Rebels.

outown

Our Town Essay

by

Eric Harris

period 1

Mrs. Caruthers

4/18/97

In the play, Our Town, there were many themes. One theme was daily life. This theme was used in the first act and had a lot of foreshadowing in it. The play illustrated this theme by showing George and Emily in their early teenage years often, and by telling the audience about the town's life, such as small facts or history about the town. The theme was also illustrated by showing what went on in the homes of the families.

The play, Our Town, showed George and Emily in their youth, before they know that they were in love. This is a prime illustration of daily life in the town. The play showed George and Emily flirting, and talking late at night. This implied that they might be together later in the play or even be married. This was a good example of daily life since they did get married in the second act.

During the first act of the play, the narrator and Mr. Webb talked about the town in general. They mentioned the geological and economical status of the town as well as a few of the inhabitants. This was a good example of daily life because that particular point in the play all the narrator is doing is giving the audience information. Nothing is happening and no events are taking place that would require the audience to see in order to get a better feel of the play.

The main goal of the first act was to show what went on inside the homes of the main families. Most of the scenes took place in the Gibbs house or the Webb's house. This showed the normal, everyday life of the families. Also, the play would show the families having breakfast or the families talking with themselves. This showed some of the normal things that

occured in the town. Another example of this was when the families would talk amongst themselves at night or during school. This was showing the every day life of the families in the town.

In the play, Our Town, there was one main theme for each of the three acts. Daily life was the main theme for act one. It was illustrated by showing George and Emily in their teenage years, by telling the audience about the towns history and economic status, and by showing many scenes inside the homes of the major families.

Papillon is one of the best novels I have ever read. And I have read many good novels. Written by Henri Charriere, he tells of his years in the French penal colonies in the northern part of the French Guiana, which is directly north of Brazil. The time frame of the novel is the 30s and 40s. Papillon was sent to hard labor for life after he was convicted of killing a man. Although he says he is innocent, the jury found him guilty without any true physical evidence. Throughout his first few weeks of his prison life, all he could think about was how to get his revenge on the jury, the prosecutor, and the judge. However, as the months passed by, he was convinced that he must escape. With the help of some of his closest friends and a few outside connections, he made an escape only 42 days after his arrival in prison. Throughout his first cavale (or escape, as we would call it), he encounters many problems. For example his boat turns out to be worthless, or they don't have the proper sailing supplies, and many other problems. However, many of the strangers help out Papillon and his fellow escapees. This is one of the most surprising aspects of this novel, the hospitality shown by these complete strangers when they know that they are helping escaped convicts. Papillon is eventually caught and sent to solitary confinement for two years. After many more escape attempts and more years in prison and solitary confinement, he is sent to an island where the prisoners are allowed to live in their own huts and garden and do as they please all day long. Papillon finally escaped from this island by using a coconut raft and after days of floating in the sun, he reaches freedom. The theme of hospitality in this novel is astonishing. These people knew what would happen if they were caught helping the fugitives, but they still gave them advice, directions, clothes, food, shelter, cigarettes (which was one of the few pleasures of prisoners), and many other useful items.

The first man Papillon came across after his escape from Saint Laurent du Marr-On-ee was a woodsman named Brenton. Papillon and his 2 friends, Clousiot and Maturette were waiting in the brush for their other escapees to come with supplies for their boat. One of the days Papillon was found by Brenton, who instead of turning the convicts or even shooting them on the spot, he helped them out. He wanted to see that they had a safe journey to freedom and that their boat was sea worthy. The Brenton gave them detailed directions to an island in order to get a better boat, he gave them one of his boats, and didn't even ask for anything at all in return. To me this is one of the best examples of kindness and concern for a fellow man in need. The Brenton could have shot the 3 men on the spot because he was out hunting for birds, or he could have turned them into the police where they would have faced either death or severe punishment. It was hard to believe that a man living alone in the wooded area next to a French penal colony would be so willing to help 3 dangerous criminals. After the Brenton sent them off to find a new boat for their journey to safety, he mentioned that the island that they would be going to ("Ile aux Pigeons") is inhabited by lepers. Leprosy is a devastating disease that cause the body to literally fall apart. It is contagious only by touch so the French send all criminals who have the disease to this island. Once Papillon arrived at the island, he was greeted with a welcoming hand...so to speak. The lepers could not believe that a man would come to the island voluntarily for any reason at all. Papillon and the leader of the lepers discussed the matter about getting a new boat, and agreed on a deal. The lepers then retrieved a very nice boat, and spent days fixing it for the fugitives. All the while the lepers invited them in for food and shelter. The lepers have separate eating bowls and plates for the few travelers they receive. Then, after the boat was ready for departure, the lepers gave...GAVE the 3 men a large amount of money, rum, tobacco, and many other very useful items to be used on the trip. They lepers explained that they hardly ever use

money and that they would be happy to lend a hand to escaped convicts. Papillon was without words as the lepers displayed this amazing show of kindness. And myself, I could not believe that these men, some without a face or hands or feet, gave so much to three strangers. And the fact that they cared for Papillon and his friends, they made sure that they didn't get infected or have any troubles during their stay. This was one of the most surprising displays of human concern in the entire novel. It was great to see men from totally different communities and backgrounds helping out three escaped criminals to get to freedom. And only for a small amount of money. The generosity by the lepers was almost indescribable by Papillon. If it wasn't for the lepers, Papillon and his friends would never had made it as far as they did on their first escape attempt. The last display of hospitality and generosity that I choose to discuss is when Papillon and his friends landed at Trinidad and met a wealthy English family. The law in Trinidad is that escaped prisoners would be sent back to prison in about a week if they choose to stay in Trinidad. The family that the three came across was more than happy to invite them into their home and let them stay for days. This family of 3 let the prisoners shower, shave, get brand new clean clothes, eat as much food as they wanted, stay in the house, get medical treatment, and just about any other thing imaginable. It was as if the prisoners were relatives staying for a few days. That is how well they were treated. The daughter of the English couple was fascinated by the prisoners and talked to them for hours about their adventures. Then, something happened that shocked Papillon completely. The man of the house, Mr. Bowen, left for an entire day. Leaving his wife and daughter alone with Papillon and his friends. That man put enough trust into Papillon to leave his house and family with him! This was so amazing for Papillon he couldn't think of what to do in return for all of his hospitality. The groups talked for days, ate together, and shared stories together. Upon Papillon's departure, the daughter gave him the address of the house, asking him to write them back sometime to let them know if they made it to freedom. Time after time, Papillon was astonished by how much these total strangers cared about another's life and freedom. He only wished someday he could return the favor to the Brenton, the lepers, and the Bowen family.

In conclusion, the theme of hospitality, generosity, and care for fellow man is one of the most outstanding themes in this novel by Henri Charriere. Henri Charriere is probably one of the few people living that have seen human nature at its best. With his encounter with the Brenton in the wooded marshy area, or his stay at the leper island, or his visit at the Bowen house in Trinidad, he has seen more kindness and caring then most people will see their whole lives. If only everyone could have the chance to experience what Papillon experienced. This novel is probably my favorite book to read, not only because its display of human nature, but its display of what prison is like in the French penal colonies, and what it was like to fear for your life every day from fellow inmates and even guards. This novel, I believe, should be required reading material for all students. Its just that good.

This female, who I will call Betsy, is a sad woman. She spends all of her time in front of a mirror putting make-up on. She seems like a slutty, trendy bitch that people like to look at since she seems "pretty" by the social standards. She feels very dense, she just smiles and says "gosh, OK!" in a cheerful but dumb manner. She just wants to be liked. She doesn't know she is different, she thinks she is normal and not different. Some words that would describe her are dense, stupid, shallow, and dazed. She feels happy yet uncomfortable. She is covered with pasty-tan make-up and has golden hair. She smells of cheap perfume and hairspray. I hear wind...or the ocean...when looking at her. She remembers that she has an audition coming up for a cheap B-movie part where she thinks she will be acting. She feels smooth yet cold. The taste of polyester comes to mind.

Eric Harris
Period 2
5/6/97

No Jobs.

Today I was walking down the street and I saw a very depressing, disturbing site. Fred Bell, a former millionaire, was selling apples. Mr. Bell used to be a very wealthy man. He had nice automobile, a fabulous house, and a wife. Then he lost all of his money in the great crash, all of his possessions were lost almost over night. His wife and only son left him to go live on a farm in Kansas. Later I heard of large dust storms that roared through the plains of America. It caused farmers and homesteaders to leave their homes and look for work just like all of the other unemployed people.

My name is John Smith. I was Mr. Bell's butler. He was a very nice man, always caring about everyone. It is real strange to see a man in a nice suit and expensive cane on the street selling apples. A millionaire to a hobo in just a few days time. As for myself, I seem to be doing just about the same thing as everyone else. Waiting in kitchens and breadlines for a piece of food. Fighting for water...or liquor, wichever is more abundant.

Life has been hard lately. Ever sense the Great Depression started, there has been no hope for almost anyone. Herbert Hoover is out of office now. Franklin D. Roosevelt is president now. He is probably the best man ever for the job. Hoover was a hopeless failure as a president and most people blame him for their problems. However, once Roosevelt and his New Deal

came into action, people started to feel better. More jobs were created so more people could work instead of living by a river with no house and only a dog or a doll to keep them company.

There was another riot today at the kitchens. Apparently someone got 2 servings when everyone else only got one, and that person went and tried to get three when some guys saw him. I don't know what happened to that man. Once the fighting was over, I could get some food. At least there was some left, sometimes after fights people will just run up and grab what they can.

I haven't worked for three months now. My last two jobs were in a factory making bags. Then I was fired when they found someone that would work for less money. At the current wages, I'm surprised anyone can maintain a job. People will start work, then the wages would lower a bit every week. Then they would go on strike demanding an increase, then the workers would be fired and others would get the empty jobs.

Mr. Bell was having a hard time when I saw him again today. I would have been devastated to find out my wife and son were dead, but he took it calmly. They had been driving west when their car broke down in the middle of a dust storm. I feel sorry for Mr. Bell, he was such a nice man. He never deserved to be doing this. No one ever deserved to be like this.

Interviewer 1 Qu'est que tu as fait quand tu es rentré de Geneve?

Dacier
Lemaitre. Je suis allé au café seger. J'ai pris rendez-vous avec Catherine et
Lemaitre.

Interviewer 2 Pourquoi, es-tu allé ce café?

Dacier
voudrais voir J'ai rendez-vous avec Lemaitre pour lui donner le virus. Je
 Catherine avant ce rendez-vous.(Catherine Smiles)

Interviewer 1 Qu'est-que tu as fait avec Lemaitre?

Dacier Je lui donné le cirus.

Interviewer 2 Qu'est-que vous avez fait apres?

Catherine
a donné Nous sommes alles a la police pour leur dire notre histoire. Dacier
 le capsule a l'inspecteur pour analysisé.

Dacier
Gaillard n'a Je n'ai pas su que ce capsule contenu la glycérine. Inspecteur
 pas couru l'histoire.

Interviewer 1 Qu'est-que l'inspecteur a fait?

Dacier Il a remplix un report et il est allé au laboratoire.

Catherine Il est vide, et M. Lemaitre n'est pas a Paris.

Interviewer 2 Qu'est-que vous avez fait?

Dacier
publicitaire.
chez eux. Nous
qui contenu le virus. Nous sommes allés au Saint-Marc ou Lemaitre a fait un film
 Nous avons decouvert ou ils etaient. Nous sommes alles
 avons cherche tout le maison pour l'autre capsule

Catherine
Bisson a
est mort. Mme Lemaitre et Mme de Bisson est arrivé. Il y a une lutte, et Mme de
 chatoyant moi. Jean et Lemaitre ont combattu et Lemaitre
 de Bisson est parti.

Dacier C'est notre histoire.

Interviewer 1 Qu'est que vous allez faire?

Dacier Je cois que nous sommes reste.

Interviewer 2

Nous allons rentrer a (Will and Jason) pour le nouvelle.

Battle of Plattsburgh

The battle of Plattsburgh took place in northeastern New York in September of 1814, during the War of 1812. Many factors led up to this confrontation between British and American troops. This battle was a major upset for Great Britain and a major gain for the United States of America.

Great Britain was planning to attack and take hold of northern New York after they suffered losses in Detroit, Pensacola, the battle of Horseshoe Bend, and especially the battle at the Thames River in October 1813. That battle had two major consequences for the United States of America. We regained the Great Lakes region the great Indian leader Tecumseh was killed. He was a large threat to the settlement of almost all Indian lands in the northwest territory, so his death resulted in the full control of northwestern America. Another important win for the United States of America was when General Andrew Jackson defeated the Creek warriors in Alabama. Here, over a thousand of Tecumseh's warriors were dug in to the bend of a river and thought they were protected. They were wrong. General Andrew Jackson destroyed their army and only lost twenty six men. This forced the Indians of the South to surrender about twenty million acres of their land. By the time of the Battle of Plattsburgh, most of

the Indian tribes were defeated and pushed farther west, and many Great Britain forces had been destroyed. One of the largest events in the war happened in Washington weeks before the battle in Plattsburgh. Since the defeat of Napoleon Bonaparte allowed all of Great Britain's armies to come to America and fight, the American's armies were outnumbered. Great Britain headed strait for our nation's capital and arrived in August of 1814. Easily passing the defenses of Washington, they burned almost all government buildings to the ground on the night of August 24, 1814. This gave Americans extreme anger and hatred towards Great Britain. This might have been a large reason Americans started to win most of the battles afterwards. Americans wanted to pay Great Britain back. After the British soldiers were defeated in Baltimore, Britain decided to attack the northern region of New York.

On September 11, 1814, a British fleet of four ships and about a dozen rowing galleys arrived in northern Lake Champlain. Commanded by General Sir George Prevost, the British soldiers marched along Plattsburgh on the west shore of Lake Champlain. Master-Commandant Thomas Macdonough was the commander of the American fleet in Plattsburgh. He had four ships and about ten rowing galleys. Macdonough had anchored his ships across the mouth of Plattsburgh Bay, therefor the British ships had to

Plattsburgh

Battle
of
Plattsburgh

Eric Harris

period 7

12/6/96

approach him head on. Another wise move by Macdonough was to arrange the anchors and cables of his command ship, the *Saratoga*, so he could turn the ship to its broadside in a crucial point of the battle, to use more cannons. The British were expecting reinforcements to help them in their attack. Unfortunately, they never came. Due to the very wise and effective decisions and actions of Master-Commandant Macdonough's, also due to the lack of British reinforcements, the United States of America won this last major battle in the War of 1812.

The battle of Plattsburgh resulted in total control of the northern part of New York and practically the whole far-north region of the United States of America. Using his knowledge and skill in warfare, Master-Commandant Macdonough totally annihilated General Sir George Prevost's fleet and suffered only minimal losses. However, if the British would have had reinforcements to back their initial fleet up, Macdonough might have lost the battle. If that would have happened, Great Britain may have been able to establish a major threat in the northern states of America. In conclusion, the battle of Plattsburgh was the last major battle in the War of 1812 and resulted in the retreat of British troops from northern American soil.

Battle of Plattsburgh

The battle of Plattsburgh took place in northeastern New York in September of 1814, during the War of 1812. Many factors led up to this confrontation between British and American troops. This battle was a major upset for Great Britain and a major gain for the United States of America.

Great Britain was planning to attack and take hold of northern New York after they suffered losses in Detroit, Pensacola, the battle of Horseshoe Bend, and especially the battle at the Thames River in October 1813. That battle had two major consequences for the United States of America. We regained the Great Lakes region the great Indian leader Tecumseh was killed. He was a large threat to the settlement of almost all Indian lands in the northwest territory, so his death resulted in the full control of northwestern America. Another important win for the United States of America was when General Andrew Jackson defeated the Creek warriors in Alabama. Here, over a thousand of Tecumseh's warriors were dug in to the bend of a river and thought they were protected. They were wrong. General Andrew Jackson destroyed their army and only lost twenty six men. This forced the Indians of the South to surrender about twenty million acres of their land. By the time of the Battle of Plattsburgh, most of

the Indian tribes were defeated and pushed farther west, and many Great Britain forces had been destroyed. One of the largest events in the war happened in Washington weeks before the battle in Plattsburgh. Since the defeat of Napoleon Bonaparte allowed all of Great Britain's armies to come to America and fight, the American's armies were outnumbered. Great Britain headed strait for our nation's capital and arrived in August of 1814. Easily passing the defenses of Washington, they burned almost all government buildings to the ground on the night of August 24, 1814. This gave Americans extreme anger and hatred towards Great Britain. This might have been a large reason Americans started to win most of the battles afterwards. Americans wanted to pay Great Britain back. After the British soldiers were defeated in Baltimore, Britain decided to attack the northern region of New York.

On September 11, 1814, a British fleet of four ships and about a dozen rowing galleys arrived in northern Lake Champlain. Commanded by General Sir George Prevost, the British soldiers marched along Plattsburgh on the west shore of Lake Champlain. Master-Commandant Thomas Macdonough was the commander of the American fleet in Plattsburgh. He had four ships and about ten rowing galleys. Macdonough had anchored his ships across the mouth of Plattsburgh Bay, therefor the British ships had to

approach him head on. Another wise move by Macdonough was to arrange the anchors and cables of his command ship, the *Saratoga*, so he could turn the ship to its broadside in a crucial point of the battle, to use more cannons. The British were expecting reinforcements to help them in their attack. Unfortunately, they never came. Due to the very wise and effective decisions and actions of Master-Commandant Macdonough's, also due to the lack of British reinforcements, the United States of America won this last major battle in the War of 1812.

The battle of Plattsburgh resulted in total control of the northern part of New York and practically the whole far-north region of the United States of America. Using his knowledge and skill in warfare, Master-Commandant Macdonough totally annihilated General Sir George Prevost's fleet and suffered only minimal losses. However, if the British would have had reinforcements to back their initial fleet up, Macdonough might have lost the battle. If that would have happened, Great Britain may have been able to establish a major threat in the northern states of America. In conclusion, the battle of Plattsburgh was the last major battle in the War of 1812 and resulted in the retreat of British troops from northern American soil.

Bibliography

The World Book Encyclopedia (volume W)

and

The Story of America (History text book)

Battle
of
Plattsburgh

Eric Harris

period 7

12/6/96

JC-001-026694

ramm1

heirate mich

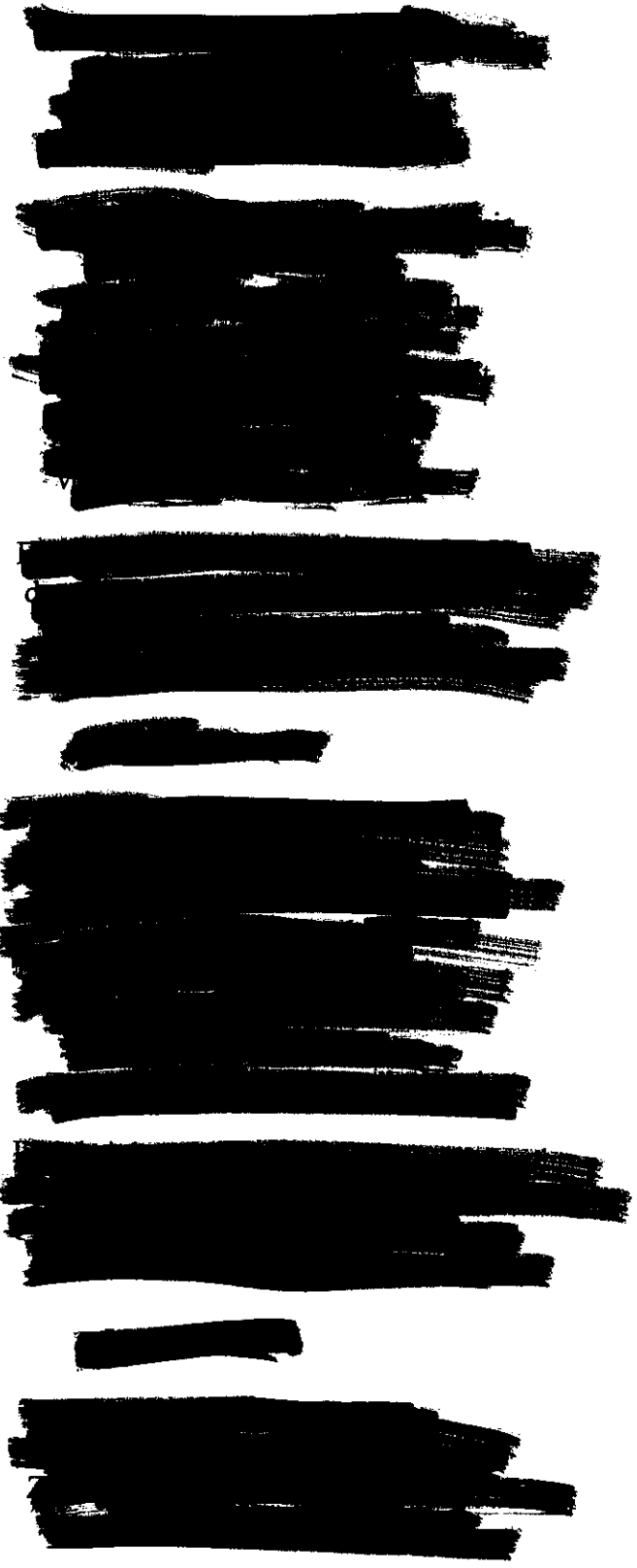

Rammstein

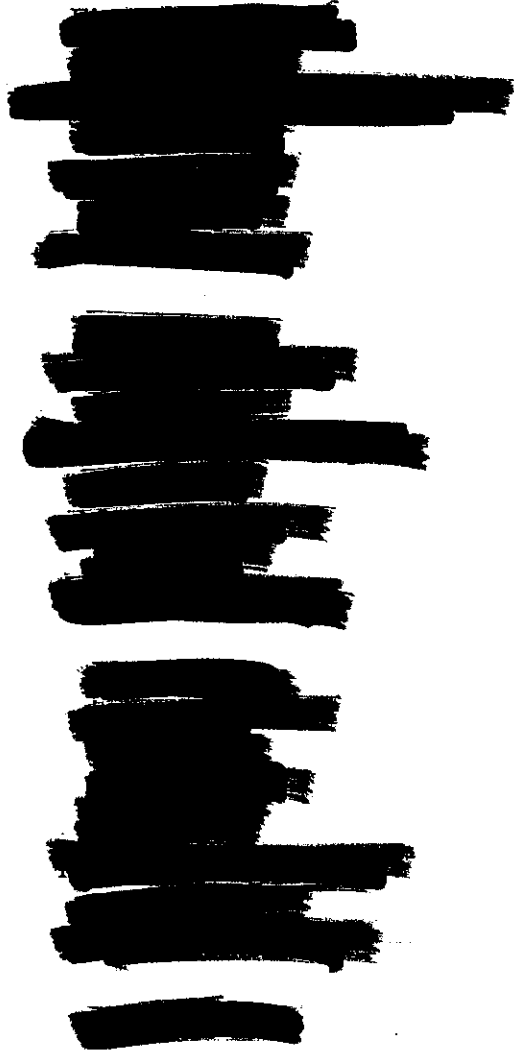

---NEWS---7/25/98---

I had enough of that rammstein discussion. please do not send any more email my way complaining about them. just because KMFDM too started out in germany and we brought rammstein over to the usa for their first time doesn't make us responsible for them. SO WHAT HAPPENED ? DID THEY WIN THE MTV AWARDS ? ARE THEY OPENING FOR MANSON ? JUST WONDERING... OF COURSE THEY ARE "A BUNCH OF POSERS" AND "HARDLY MORE EXCITING THAN A TRAVELING FLEA-CIRCUS". OF COURSE THEY'RE ANOTHER "FAKE" "HYPE" {sic!} "FROM GERMANY", [JUST LIKE].... "THE SCORPIONS".... BUT ISN'T THAT WHAT YOU DESERVE ? DIDN'T YOU TOO HELP THEM TO BECOME JUST THAT ? DIDN'T YOU PLAY PART IN IT BY SPENDING YOUR MONEY ON THEIR STUFF, SUNG IN A LANGUAGE MOST OF YOU AMERICANS DON'T EVEN UNDERSTAND ? THEY ARE WHAT THEY WANT TO BE, ALMOST

SUPERSTARS.

UNLIKE KMFDM, THEIR (DECLARED) PRIORITIES ARE:
FIRST MONEY, THEN THE MUSIC...

INTERESTINGLY ENOUGH IS THE WAY RAMMSTEIN ARE REGARDED IN THEIR NATIVE GERMANY COMPARED TO THE U.S.:

I GOT A LOT OF FLAK FROM EUROPEAN 'HARDCORE' KMFDM-FANS, FOLLOWERS SINCE THE HUMBLE BEGINNINGS,

ACCUSING ME OF ALL KINDS OF THINGS IN REGARDS TO "OPENING UP FOR THAT SELL-OUT BAND". CLEARLY IN EUROPE

THEY ARE REGARDED AS A JOKE AND A MONSTROUS MONEY-MILKING RIP-OFF, APPEALING ONLY TO A 'BRAINLESS'

SUB-URBAN MOB, DRUNKEN HORDES OF HEADBANGERS ON THEIR ARENA-SIZE TOURS (BELIEVE ME, I'VE BEEN THERE...)

ETC., WHEREAS HERE IN THE STATES PEOPLE THINK OF THEM AS "PIONEERS", "COOL", "UNDERGROUND" ETC.

IF YOU KNEW THE LEAST BIT ABOUT GERMANY, YOU'D MAYBE UNDERSTAND THIS PHENOMENON, BUT REST ASSURED THAT

YOU DON'T GET DOUBLE-PLATINUM IN GERMANY WITH ANYTHING THAT CAN BE REMOTELY CONSIDERED "COOL" OR

"UNDERGROUND"..... OH, THE SILLINESS OF IT ALL ! [soon i'll receive complaints about the gnashing bumpkins....]

sammiryx

stoop down - I command you

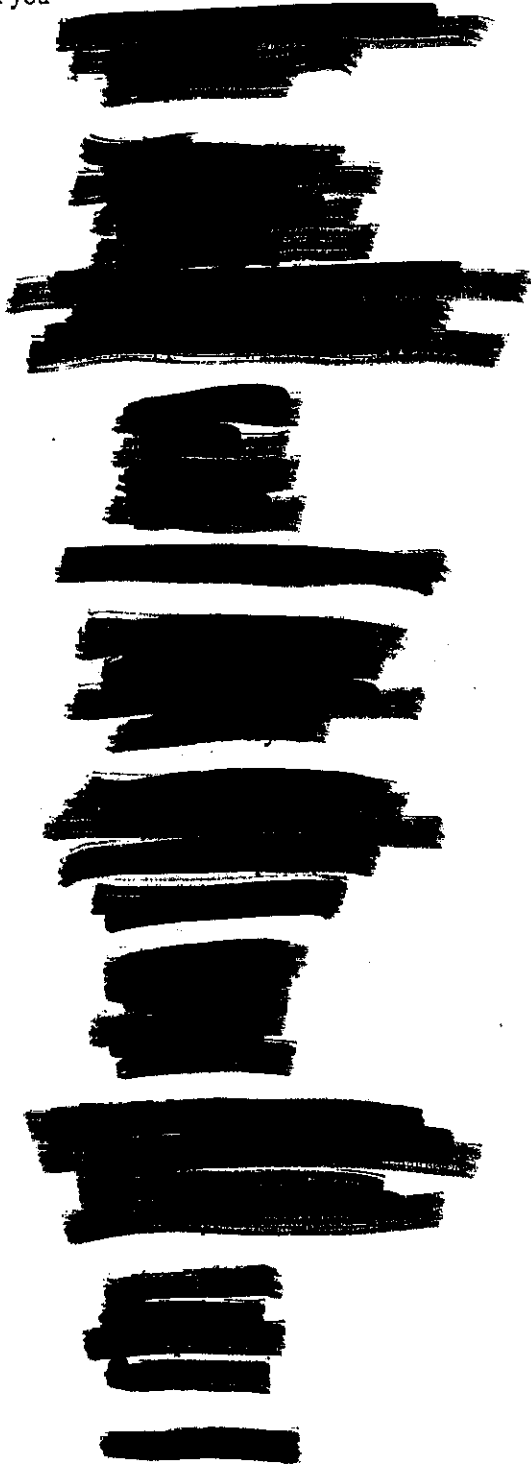

What does a man do

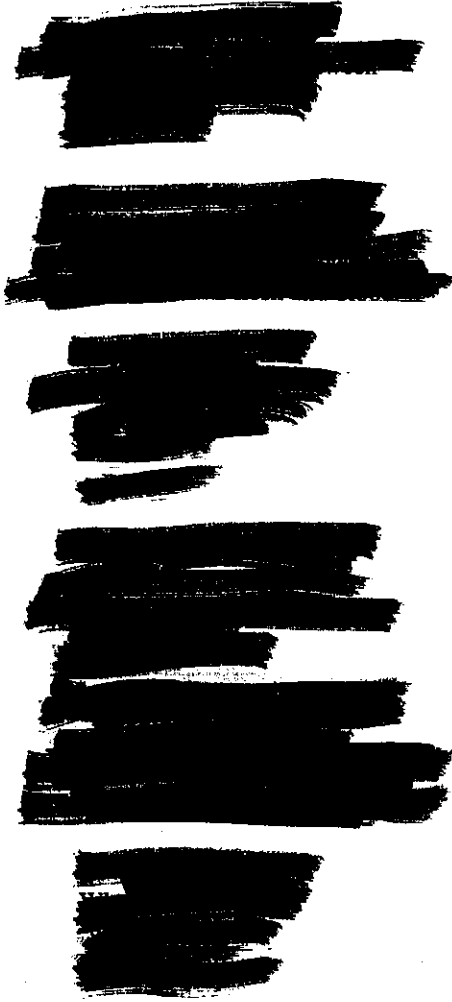

Punish me

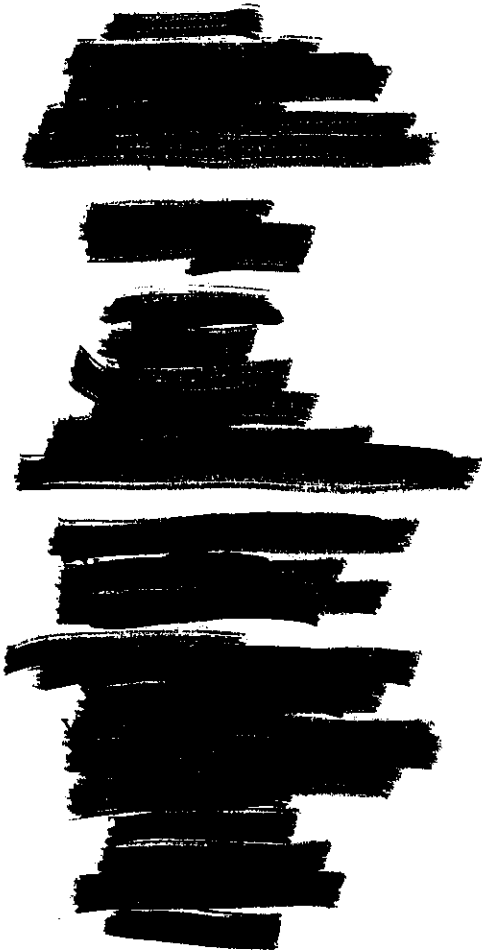

They tell me

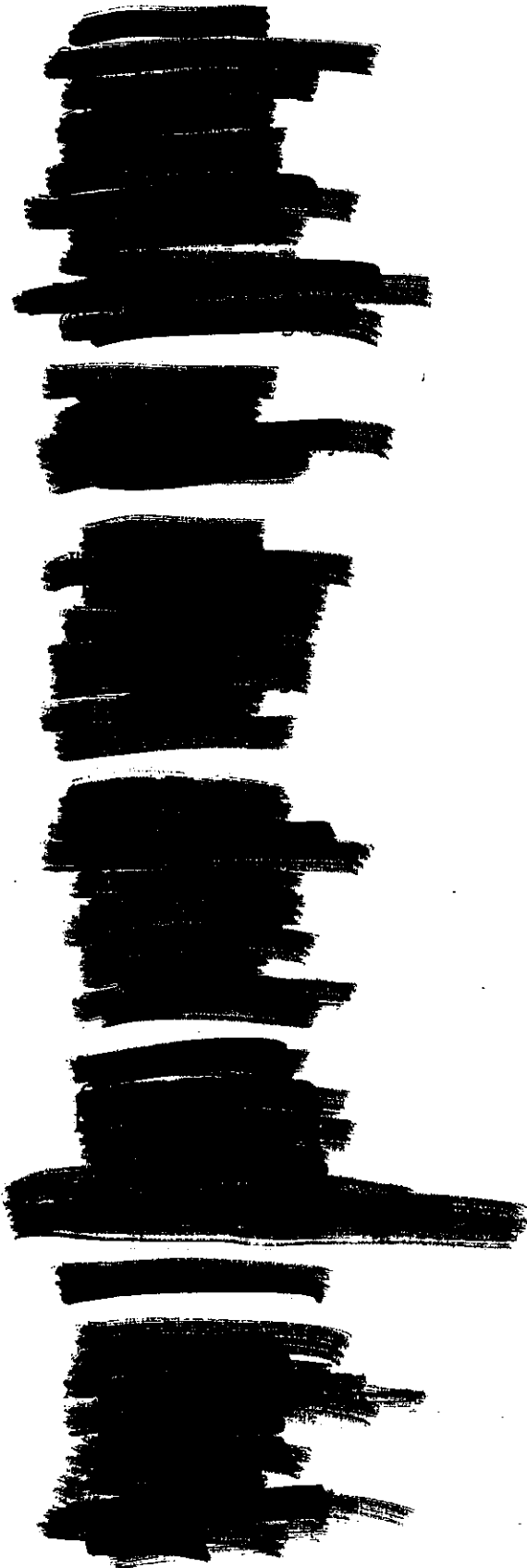

bück dich - befehl ich dir

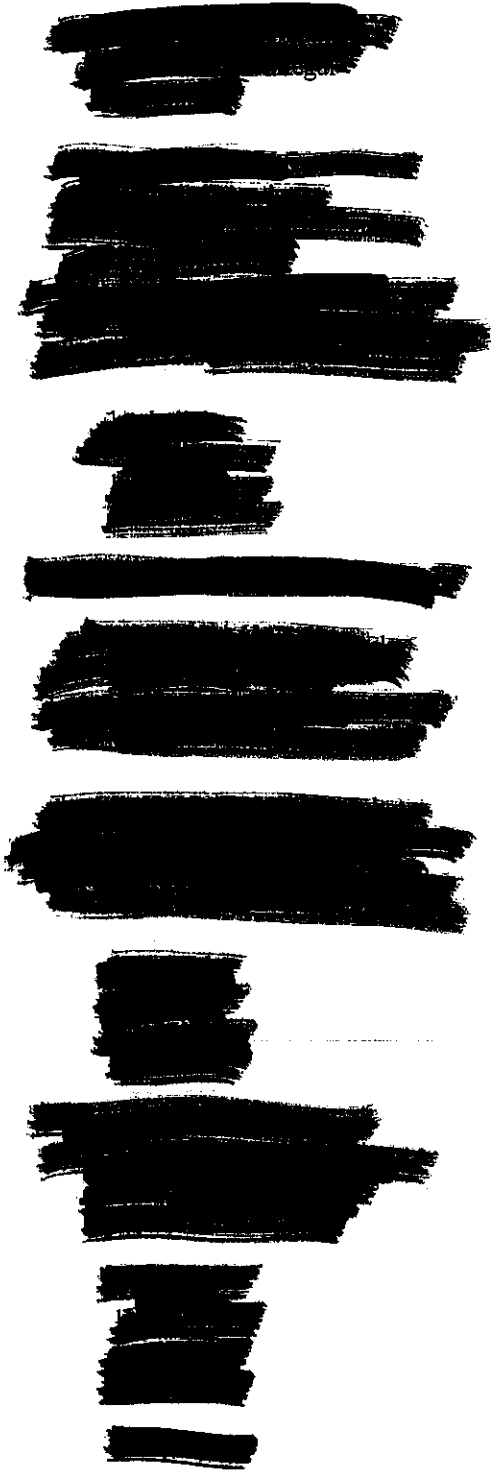

Was macht ein Mann

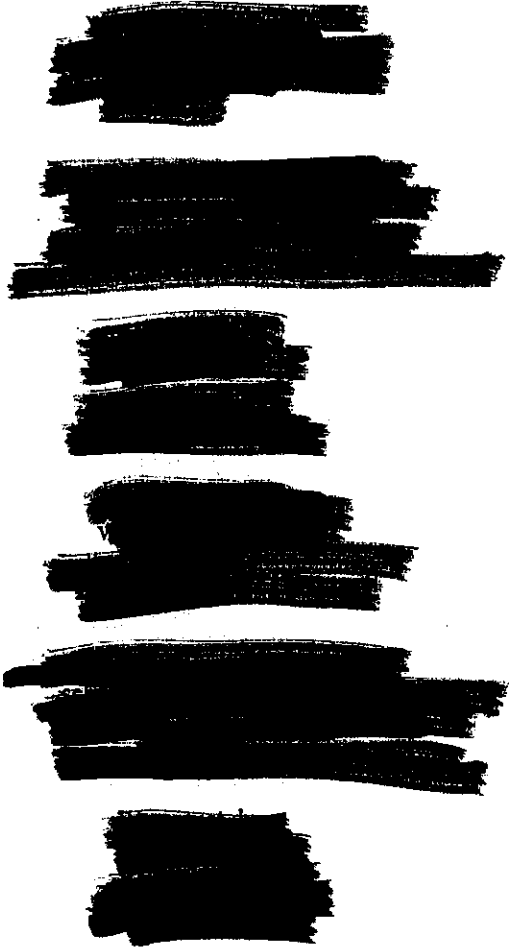

JC-001-026707

Bestrafe mich



Sie sagen zu mir

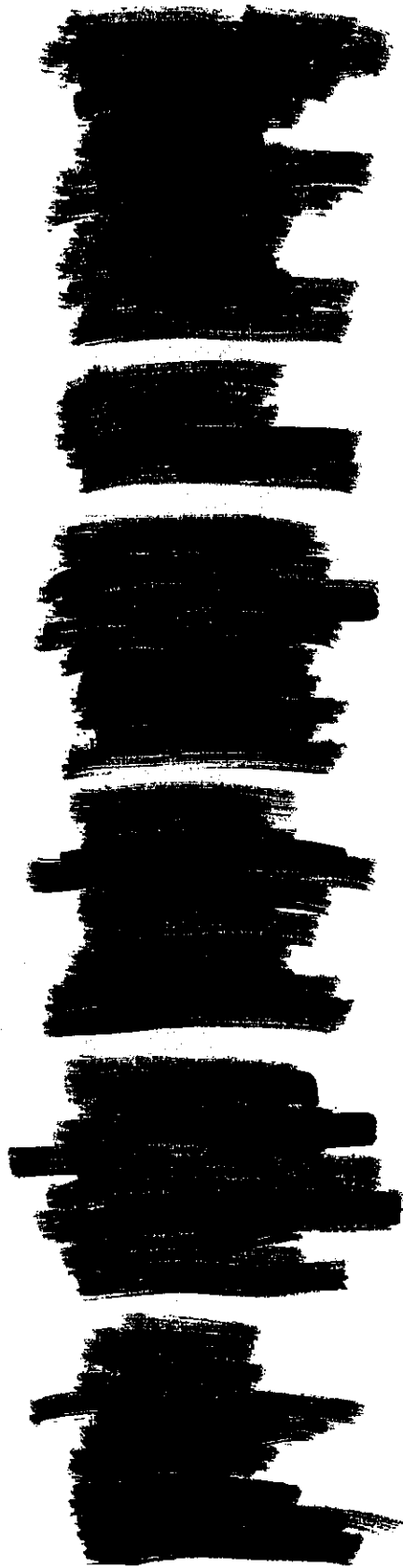

The Nazi Culture

How many people can a football stadium hold? Can it hold fifty, sixty thousand? Most stadiums can. Now, picture a stadium filled, not just seats but the field and all the air above it, with dead men, women, and children. That is just a fraction of the casualties inflicted by the Nazis, also known as the Third Reich. Through the 1920s and 1930s ideas from the past and basically anything that seemed interesting to Adolf Hitler was added into the government policies. Nazism was a form of government unlike any other in history, with their beliefs and policies, their racism and hatred, their very strong family values, and the plans they had in store for the rest of the world.

The word "Nazi" itself is synonymous with "racist." The Third Reich, in its early years, was a form of government that was like a magnet, sucking in anything that could build on the racist foundation laid out by Hitler. Theories and policies from the past were resurrected to go alongside the growing power of the nation. A perfect nation was their goal. With Hitler leading the National Socialists, or Nazis, with his astonishing political skills, they adopted symbols from the past and made policies to turn Germany into a National Socialist country.

Some people ask, "how did such an evil empire come to be?" The answer is simple. Germany needed a leader and Hitler was the best leader Germany had. His persuasive, manipulative speeches and his promises for a great nation were enough to get almost the entire German community to strongly support him (Nyomarky 12).

The Germans wanted something to be proud of, and Hitler was able to provide it for

them. With Hitler saying things like, "The common interest before self interest," and "Love Germany more than anything, and your fellow Germans more than yourself!" the German people felt like they were part of something special and exciting (Remak 39). His orders, whether written or oral, "cancelled all written law" (Nyomarky 12). The German people accepted this and loved their leader. They were glad to see Germany being brought out of the depression they were in. Germany, "under the Nazi regime," was overcoming the effects of the great depression (Remak 75). This boosted the community's moral. Hitler got the Germans moving again and gave them something to strive for. A certain energy, "...a feeling that things were moving again, that a new energy had been infused into German life," as described by one citizen, was moving through Germany (Remak 71). A new social structure was being formed, with Hitler and his ideas at the top.

The Nazis used several ancient runes in their flags and military signs, along with special code words used by officers. The swastika itself, a symbol imbedded into many minds as a symbol of evil, was derived from an ancient rune known as a *Hakenkreuz*. It was a pagan Germanic symbol of the God of Thunder known as Donnor or Thor ("History"). Its red background indicated the "social idea of the movement," and the white circle indicated its "nationalism" (Thornton 25). The Nazi's "SS" symbol was also an ancient Pagan rune, known as a *sig-rune*. By itself the sig-rune was only one large lightning bolt-type "S" which symbolized victory ("History"). A badge manufacturer, who just put two of the *sig-runes* together, made the discovery of the "SS" symbol. Code words, such as Aktion T4 and KZ were used often by Nazi officers. Aktion T4 was the code name of the euthanasia program that

led to the killing of approximately 100,000 lives that were “not worth living.” Aktion T4 was named after the relevant government department of the Reich chancellery located on Tiergarten Strasse 4 in Berlin (“History”). KZ stood for Konzentrationslager, which means concentration camp. It was used constantly by Nazi officers and soldiers to somewhat lessen the idea of the camps, and what they were used for (“History”). The Third Reich was definitely a unique government, using symbols from ancient pagan runes and coming up with entirely new and extremely racist laws.

Racism was rooted into the Nazi government just like freedom is rooted in America’s government. Laws for censorship, foreigners, and duties of citizens were all intended to protect the state. Hitler once stated that “We have to put a stop to the idea that it is a part of everybody’s civil rights to say what he pleases” (Remak 83). Strong censorship was imposed in Germany against books, articles, magazines, films, and even art. Nazi rulers had complete control over what they wanted their citizens to be seeing, hearing, and reading. They indeed “...had a free hand to determine[,] if it could, every man’s attitude toward life,” (Moose xxi). Euthanasia is a current topic in today’s American society, but in Nazi Germany, all mentally disabled people or “incurable mental defectives” were killed due to the Aktion T4 project, more commonly known as the Euthanasia project (Thornton 28). A citizen had strict duties and at the top of their list was working for the good of the state (Thornton 24). Aliens, on the other hand, were to be discriminated against. The German people wanted only pure German people in their country, any others were to be “disposed of.” Therefore, foreigners had few rights, and Jews in particular were to be hated

(Thornton 24). The concepts of racial superiority, national community, and leadership were most popular in the Nazi's *weltshauung*, or world view.

Hitler made almost everyone in Germany have a sense of national pride. Policies were made to strengthen the pride and weaken resistance. Strong propaganda techniques using intimidating symbols allowed the Nazis to rule in Germany. With Hitler's ideas and the racism involved in the Third Reich, the killing of millions of people from "inferior races" was deemed necessary. The number of deaths the Nazis are responsible for will never be known, however it is believed that from the concentration camps alone, over eleven million people lost their lives. The Third Reich almost completely wiped out the Jewish population in Europe in the late 1930's and early 1940's. Now in our minds, that is utterly inhumane, immoral, and evil, but in the Nazi's minds, it was perfectly fine to exterminate an entire race. The majority of the world's population considers the Nazis evil because of the concentration camps and the treatment of the Jewish race.

The Nazis had a distinct hatred for the Jewish race. They wanted the entire race exterminated and the best, most efficient way of doing this was to make concentration camps. Nazi doctors controlled life and death in most of the concentration camps. Prisoners considered one doctor, Joseph Mengele, as "...a non-human, evil force...the lord of life and death" (Lifton 345). The wife of a high-ranking Nazi officer near Buchenwald was known to have collected "lampshades, book covers, and gloves made of human skin from murdered concentration camp inmates" (Infield 75). In the earlier years, shootings were the more "popular" way of disposing of Jews. The shootings were very secret though, and since almost all

“shootings took place beyond Germany’s borders,” it was easier to keep shootings out of the news (Remak 154). Sometimes twisted Nazi officers would line up prisoners and fire a rifle round into the first just to see how many chests it would go through. As time passed, gas chambers and crematoriums became responsible for most of the killing. An SS guard once said, “the killing way easy...they just went in expecting to take showers and instead of water we turned on poison gas” (Infield 76). Gassing was indeed the most efficient method. Because of “...occasional emotional difficulties encountered by the executioners, who might balk at shooting children, for instance, gassing proved by far the most efficient method,” (Remak 158) says an SS guard in regards to gas chambers. Methods of killing did vary. In a city called Riga convicts were released, given iron bars, and ordered to kill Jews (Remak 152). The hatred was constantly reinforced through speeches from people like Hitler and Himmler. Himmler once said “whether or not 10,000 Russian women collapse from exhaustion while digging...interests me only in so far as the ditch is completed for Germany,” (“History”) which implies that all he cares for, and all he wants everyone else in Germany to care for, is Germany. Millions of people died as a result of the concentration camps.

The amount of hatred for the Jewish race was incredible. The Nazi’s hatred “was symbolized for them by the Jews,” who very often became targets, scapegoats, and the usual suspects (Thornton 10). Nazis constantly insulted the Jewish race. They were not even regarded as human beings, only “an appearance of putrescence” (Moose 336). It helped them to build the hatred for the Jews. Public speeches like “the Jew is...a parasite, a sponger...a pernicious bacillus...his presence is also like

that of a vampire; for whenever he established himself [,] the people...are bound to be bled to death..." (Thornton 10) were also used to boost the hatred in Germany. It was all part of their beliefs and they saw nothing wrong with it. "The inhuman persecution of the Jews that the Nazis carried out was firmly based on their view of life," and therefore, in their own minds, killing was right (Thornton 5). In order to maintain their government the Jewish race had to be forced out of the picture.

Many people today have a hard time picturing the overall impact of the concentration camps. One of the largest goals of the Third Reich was to destroy the Jewish race, and they almost did. The Nazis killed approximately six million Jews using gas chambers and firing squads. While the "inferior" Jewish race was being exterminated, the "superior" Aryan race was striving to become stronger workers and families. Family values in Nazi Germany were very strong. Germans wanted to keep their families strong, healthy, and active. Education was revised, the woman's role was changed, and the overall Aryan racial elements were outlined in order to have a more perfect, flawless community.

Education was not made to benefit the individual, but to benefit the state. It was very important for Hitler's youth. He wanted the highest task of education to be the preservation, care, and development of the best racial elements (Pine 1). It was also used to make a more perfect generation of Germans, who were strong and prepared to sacrifice and undertake responsibilities towards the nation community (Pine 1). In order to do this, textbooks and schools were reformed. Nazi symbols were often used within domestic themes in order to make them "familiar and more accessible to children" (Pine 2). Swastikas were inserted into books, pictures of

Hitler with children were posted in schools, and eventually school children were putting swastikas in their homes (Pine 2). Scientific and arithmetic examples in textbooks also helped the youth with their racial superiority education. Craniology, the study of the skull, was used to distinguish the “inferior” races from the “superior” races (Pine 4). Arithmetic was used to show how “wasteful” the mentally challenged were and how much money could be saved by euthanasia (Pine 5). These ideas were then transferred to German homes where parents could learn about their roles in the Third Reich.

The woman’s role, in particular, was very unique. Throughout time women have tried to be treated as equals to males. Eventually they did win their rights in America, but in Nazi Germany, the women were supposed to be “glad” to stay home and cook and clean all day long. They were to be “beautiful and to bring children into the world” (Moose 41). It was said that motherhood was in the “front rank of patriotic as well as moral virtues” (Schoenbaum 188). Women were required to raise the children, cook, clean, and look after the house. It was also “good morals for a woman to have several children” (Moose 37). However, they were still discriminated against. Women who have had “many miscarriages, or who [have] brought deformed, sick, or sickly children into the world” were considered inferior (Moose 37). They could not join in politics, nor serve in the armed forces. This was all part of the “superior” Aryan race and was considered to be the law.

Those of the Aryan race considered themselves to be members of the superior human race. All others were inferior and were constantly criticized. Extreme racism was used to show the Nazi’s superiority. The personal characteristics of the Aryan

race included honor, courage, love of freedom, and a strong spirit of scientific research (Thornton 5). Physically, the Aryans were tall, strong, and long-headed. They had blue eyes and blond hair, with a fair skin complexion (Thornton 5). Many attempts were made to increase the “pure” German blood population, such as stealing children who matched the physical requirements of the Aryan race from their homes. Himmler once responded to a question that asked “How can we be so cruel as to take a child from its mother,” by saying “How much more cruel [is it] to leave a potential genius with our natural enemy,” (Infield 138). The Nazis were very determined in forming a perfect German nation.

Breeding became a controlled issue in the Third Reich. Only the elite would reproduce (Pine 1). It became against the law for a pure-German person to breed with someone who was not. The goal was to bring together a high-grade heredity stock and to eliminate all inferior races from the German people (Moose 35). They believed that because of inferior races, like the Jews, many true German families were ruined by the result of only one “low-grade” person coming into the family. Once again, it was the Jews’ fault for Germany’s problems.

Family values in Germany were strengthened during the Third Reich. Education, along with the woman’s role, was reformed according to Nazi beliefs. The Aryan race and breeding guidelines were also outlined as a result of new policies. Despite these reforms and new policies, the Nazi regime was defeated. Most of the leaders fought until the end, turning out new plans for the Third Reich. Hitler had many plans for his nation and the world that he would never see accomplished.

Hitler's main goals were to conquer Europe and form a perfect Aryan nation. A nation would be created that would thrive on National Socialism. Hitler wanted leaders, but he also wanted all of his citizens to feel equal. "No one should think himself superior to his fellow man," even leaders should be "devoted to service and responsibilities" (Moose xxxvii). He was afraid that "intellectuals would feel superior to others because of their knowledge and thus form a separate group within the people which would be difficult to control" (Moose xxxvii). As Americans, we consider the freedom of the press as a right. Nazis, on the other hand, only allowed the freedom of the press to be permitted "within a framework conducive to the national welfare" (Thornton 24). A "strict censorship" was also placed on the publishing industry (Pine 1). Hitler wanted the people of his nation only to see what he wanted them to see, in order to have them remain loyal to the Third Reich.

Hitler had plans for Europe, as well as the world. A theory the Nazis believed was that "if youth could be captured by their world view, the future was assured" (Moose xxxii). This means the youth of the world would grow up believing in Nazism whether living in Germany or not. A large plan of Hitler's was to conquer Russia and use the land for farming and for more Germans to live on. There were going to be several "population transfers" (Remak 127) in Europe and Asia, because space was needed for the German people. Space was to be made in several ways, such as "low rations, shootings, an expulsions" (Remak 122). The people would be able to live free, just as long as the Germans were their rulers. In case of a revolution, they would "drop a few bombs on their cities and the affair will be over" (Remak 128). Judaism was also to be "destroyed" since they believed it posed an

international threat to Germany (Smith 255). This would allow more room for the German people and exterminate the main “inferior” race in Europe. Those types of events show the care, or lack thereof, for the people of other nations besides Germany. Eventually, if Hitler had won the war, the Third Reich would have spanned over the whole globe and tens of millions or more people would have been eliminated.

The Third Reich, at its prime, posed a great threat to the well being of all of the European nations, and indeed the whole world. Germany would have been a nation in which all citizens were equal, at least all of the Aryan citizens, and anyone who opposed the Nazis would be killed. Nearby lands would have been conquered and the Jewish population would have been even more diminished. Millions more people would have been killed as a result of the “population transfers” the Germans had in store for their conquered territories.

The Third Reich, led by Adolf Hitler, was one of the most evil and racist forms of government ever. The goals of the Third Reich were to make a perfect Aryan nation, destroy the inferior races, and conquer enough land to accommodate the German people. After Hitler came to power he reformed laws, policies, and family values, and set goals for the future of his nation. Reformations of education and of laws allowed the Third Reich to carry on for years. The concentration camps killed millions. The racist views brainwashed the society into believing the Aryans were superior to all other races. They were responsible for the deaths at least eleven million people. These things were all part of Hitler’s master plan of creating a perfect Aryan race to rule Germany.

Works Cited

"History." Online. Available:

<http://www.geocities.com/Vienna/Strasse/8514/history.html>. 25 October 1998.

Infield, Glenn B. Secrets of the SS. Stein and Day. Braircliff Manor, NY. 1981.

Lifton, Robert Jay. The Nazi Doctors. Robert Jay Lifton, 1986.

Moose, George L. Nazi Culture. New York: Grosset and Dunlap, 1966.

Nyomarkay. The Nazi Party. University of Minnesota, 1967.

Pine, Lisa. "Nazism in the Classroom". History Today April 1997: 22-28.

Remak, Joseph. The Nazi Years. Prentice-Hall Inc. Englewood Cliffs, NJ. 1969.

Schoenbaum, David. Hitler's Social Revolution. Doubleday Company, Inc., Garden City, New York, 1966.

Smith, Woodruff D. The Ideological Origins of Nazi Imperialism. New York: Oxford University Press, 1986.

Thornton, M. J. Nazism. Pergamon Press Ltd., 1966.

The Nazi Culture

by

Eric Harris

Mr. Webb

Composition for the College Bound

November 13, 1998

JC-001-026721

The forest green field was hot under the sun.

The game was in its 2nd overtime.

Five soccer balls were already destroyed from heavy pounding.

Injured players were being treated on the sideline.

Orders that were being yelled by coaches and players confused us.

Time was running low, as was our resources.

The ball must go through the enemy lines.

Overhead we saw aircraft flying by.

All going in our direction, seeming to give us more power.

Their defenses were so strong.

None of our attacks could punch through.

We tried several different kinds of tactics.

Through pure luck, as always, we made it through.

The defenses were smashed and we punched through to the goal.

As we celebrated our victory, we felt sorry for the other team.

But that was just too bad for them.

Great Senior Expectations

At last, the last year of my high school education has come. I will experience several new subjects, review several old ones, and no doubt learn many new and useful things that will help me in life. In general, I am expecting to learn to express my opinions and beliefs in a civilized, respectable manner. I expect to learn about people around me, how they act, and their beliefs along with learning to respect their opinions. I also am expecting to learn more about how to be a successful and respectable leader and to become responsible.

Learning to express opinions in a civilized manner is very important in the "real world." One cannot make a difference if one cannot express opinions properly. With the classes I am scheduled to take, I am expecting to learn how to do so. I want to learn how to form and record opinions and use references, statistics, quotations, and other useful ways to get my points across. I expect to learn as much as I can from my Writers Inc. book and learn to apply it to my work. This will all be very important for any college I choose to go to, if I choose to go at all. These skills will help me achieve higher scores on essays and will help me learn more about my topics. There is really no way that this will not benefit me, no matter if I go to Harvard or if I travel the world.

Different people influence my life in different ways. Therefore it is important to learn how exactly they influence me and my decisions, along with how they think and how they form their own decisions. It will also be helpful to learn how people think and why they act the way they do. This skill could help out in almost any line of work and in every day life as well. Learning of peoples' beliefs and religions is also important. It is a good value to respect everyone for who they are and for what they believe in, instead of having stereotypes and

prejudiced views. Although this may be hard for some people, and even for me, I am expecting to learn how to do these things in the senior year.

Being a leader is a very admirable quality. I respect people who are good strong leaders and know what they are doing, and I do not respect people who are weak, uneducated leaders. This is why I want to be a strong leader. I am hoping team sports and other classes will help me achieve this quality. If I am considering a military career, then leadership is an extremely important quality. I am expecting to learn how to be organized and responsible, how to treat people equally, how to listen attentively and how to solve problems logically. I am hoping my senior classes and experiences will help my goals.

In conclusion, I expect my senior year to be full of surprises. On the other hand, I want to achieve certain goals so I am a better person once I graduate. I am expecting to learn how to express my beliefs and opinions in a civilized, respectable manner, to learn to respect people around me along with their opinions and beliefs, to learn how others think and why they think that way, and to be a strong responsible leader. I believe with the classes I will take and the opportunities I will have, these expectations will indeed be met.

"No gum, nope. We can't chew any gum in Singapore," said Nixon as we talked about his hometown of Singapore. Nixon is 28 years old and is visiting the United States for training in his job at Gates Rubber Co. He wanted me to use his first name in this report instead of using his entire name, plus he said it was too hard to pronounce in English anyway! As he was explaining his hometown to me, I realized that Singapore is a lot like the United States. Business, dining, sports, and recreation are all very similar. Although, religion and customs vary quite extensively. Geographically, Singapore is very small, approximately 616 square kilometers. Its inhabitants refer to it as an "island-city" since the city itself covers most of the island.

Singapore has a tropical climate so the sports are similar to American sports. Nixon has played soccer and softball in his hometown. Rugby, badminton, and basketball are also offered. "Soccer is most popular, softball is popular too, though," Nixon explains as he remembers his younger years. Compared to Colorado, Singapore does not have skiing, snowboarding, or hockey. On the other hand, one can go on walks or go rock climbing on the island. The food in Singapore is mainly very healthy. There are traditional Chinese and Asian dishes along with the ever-popular McDonalds restaurants. The people in Singapore usually eat at home but occasionally dine out. His city is fairly up-to-date as far as electronics and businesses are concerned. Their computers are basically the same speed as ours and the late model cars suggest that Singapore has good trade relations. Nixon himself owns a computer, even though the business he works for provides an e-mail address, so he can be in touch with the rest of the world from almost any place. When asked what he did for fun in Singapore, Nixon replied, "We shop, or go to bars." The night life in Singapore is very much like America. There are bars, theaters, movies, and malls to go to after work or school is over. Nixon does not own a car or even a bike,

instead he uses the vast subway system in Singapore. The price of a car in Singapore is about three times the cost in America, plus there are many taxes and expenses that add to the overall cost.

Singapore has many customs and traditions that might seem unusual to Americans. Even though Nixon is the first son in his family, he is still pursuing his job. Usually, in his city, the first born stays with the parents after school is over. Nixon once replied, "Maybe my sister would do that for me," when asked if he would have to go back soon and stay with his mother and father.

The main religion in Singapore is Buddhism. Muslim, Christianity, and several others also play a role in his culture. Nixon is Buddhist, and believes in the ways of Buddha. Nixon briefly explained the beliefs and thoughts of his religion. One of the main points he made on Buddhism was, "The ones who follow the religion closely do not believe in having material possessions. Instead they spend their time meditating and thinking of peace and tranquility." His hometown celebrates many holidays for many religions, such as Christmas or Singapore's independence day.

The government in Singapore is a republic. The laws are somewhat similar to America. Although, some of the punishments are different. Some of the laws that are very different from America are that one cannot chew gum, consume tobacco products, or drive under 16 years of age. The legal limit for alcohol is 18 years old. To buy an apartment in the city, one must be married or engaged to be married within two years. Then, after the apartment is signed over, the couple must stay married for five years in order to keep their home. This is why most young adults live with their parents. As of now, Singapore does not have a limit on the amount of children one couple can have. In the past, the law has been as low as one child per couple

because the city was getting too crowded. When Nixon was asked if he was married he replied, "Not yet, no. No interest in marriage yet." There are many limits on seeing movies. Movies with violence or sex in them are usually prohibited from persons under 21. Pornography is completely outlawed in Singapore, along with fireworks. The Internet services in Singapore are monitored so people do not receive illegal files or information.

The average work day is the same as the American work day. Usually a person will stay with the same company for their entire career. If one is fired or quits, they are hated or shunned. So when Nixon was asked if he would stay with the Gates Rubber Company he said, "I sure hope so!"

One thing Nixon noticed about American people is that they are much more open-minded and they speak their mind more than he is used to. Most of the citizens in Singapore are quiet and keep to themselves. Americans, on the other hand, are free to do and say what they want, and according to Nixon, we do it all the time! He is surprised how much the people in America like to be individualists. "Some of the people here might even be arrested in Singapore for some of the things they do in public," said Nixon as we talked of the restrictions in his city.

The island of Singapore is located on the equator and around the tip of Malaysia, which is south of Thailand. The climate is tropical, so there are hot summers and mild winters. Nixon knew a great deal of information on his hometown, so that led me to believe that he was proud to be from there. Singapore is not very much of an agricultural economy, rather more of business and electronics. Since the island is near two major bodies of water, it is known to have many busy harbors. When asked if he has ever been on a boat though, Nixon said, "No, I do not like boats too much." He gets around this little problem by flying to wherever he needs to go. The island does have an airport and it is used quite often because of all the business travel. Nixon

said he would be returning to his home in early October. "I do like America, but I still think Singapore is better," said Nixon proudly.

In conclusion, Singapore is a very interesting place. From my new friend Nixon, I learned that his culture is very similar to America's. We have many of the same sports, businesses, and entertainment. The religions and customs vary greatly between our two nations, but the moral values and legal standards are basically the same. Nixon is a good friend and a very intelligent man. I enjoyed talking with him and I hope he will return to "our little country" soon. In the few hours I spent with him and his roommates, I learned that people from all over the world are all interested in the American ways of living and thinking, but it seems that we ourselves sometimes are not as interested in them. I believe that we should spend more time learning about other nations instead of being content with our own.

The Space Program

Lunar Prospector in Orbit Around Moon. A NASA research team has found compelling evidence that life may have existed on Mars 3.6 billion years ago. Galileo Finds Evidence of Water on Europa. These are just some of the stunning headlines in today's news regarding space exploration and analysis (Oliver). Science and technology now allows mankind to explore the greatest regions of space and the planets around the Earth's solar system. Scientists can search for minerals, water, and even extraterrestrial life on other planets and possibly visit them some day soon. The space program can be very valuable to the world in many ways, but it can also be expensive and dangerous. The amount of information mankind can learn from studying space and all of its celestial bodies is almost beyond imagination. The continuation of the space program can help mankind by learning more about Earth itself, by finding valuable resources or water on other planets, by discovering new planets for human colonization, and by finding life on other planets.

Possible arguments against the continuation of the space program are that it is too expensive and that it is dangerous for astronauts. The National Aeronautics and Space Administration (NASA) and the United States government are constantly at work to find ways to free up money for NASA's enormous budget, but they mainly want people to realize that their money is spent wisely when it comes to the space program. Some resent delays in launches of space flights have added up costs. Seth Borenstein of the Sentinel Staff states that, "The delays have caused an expensive backup in science payloads that NASA wants for study of Earth and the universe" (Borenstein). Even though, according to Dan Feldstein of the Houston Post Staff, the space shuttle has a "3.3 billion dollar annual budget," the cost of this can be cut by ceasing the continuous updating and training of new programs and hardware on the shuttle (Feldstein).

This may not be the best solution to NASA's budget, but the United States is working to find other, more sound ones. The amount of danger in the space program is very small. Very few missions in space have had problems, and not a single person has died in space to date.

Using mankind's space and satellite technology the human race can learn about it's own planet. Satellites have taken pictures of the Earth's oceans, weather, countries, and can even provide society with far greater entertainment and communication services. Satellite photos have helped mankind understand more about Earth's weather, such as hurricanes and El Nino. They have mapped Earth's oceans and provided detailed pictures of the entire Earth for people to study. Communication satellites have provided society with images of people on the other side of the planet and has allowed people to have conversations with others almost anywhere in the world from their very own living rooms. Photos from space help weather analysts track dangerous storms and allow people to evacuate homes before severe weather can hit. Mankind has been able to study the effects of global warming and the o-zone layer. The Earth's satellites has provided people with telescope pictures of distant stars and celestial bodies that no telescope on Earth could capture. Clearly the use of satellites is important and extremely helpful to the human race.

The study of other planets and moons has proved to be most helpful. Mars might have had the necessary conditions for life approximately 3.5 billion years ago and might still contain frozen water deep beneath its surface (Oliver). If someday mankind is able to find and extract this water, it can open up an entire new approach of the idea of conserving water on Earth. One of Jupiter's moons, Europa, may have had water on it at one time also according to recent findings by NASA's Space probe Galileo (Oliver). Planets or moons may soon be found to have valuable resources and within time mankind might be able to begin mining on these surfaces.

Earth's natural resources will only last mankind for so long, therefor Earth's inhabitants need to begin looking for other possibilities and methods of getting these resources. Mars and Europa are just two possible places to look.

One of NASA's program, HEDS (Human Exploration and Development of Space), has four main goals; increase human knowledge of nature's process using the space environment, explore and settle the Solar System, achieve routine space travel, and enrich life on Earth through people living and working in space (Human). Colonizing the moon and other planets can be very beneficial to mankind. New ways of growing crops can help farming on Earth. Even making new cities and space stations can provide further studies of the universe from a fixed station in space.

The most important contribution the space program could possibly make in my view is the discovery of intelligent extraterrestrial life. This may not happen for years to come, but NASA has radio satellites and astronomers looking for signs every day. A team of scientists called S.E.T.I. (Search for Extra-Terrestrial Intelligence) is in charge of this task. Searching for life in the stars is not easy nor cheap. However, if they succeed in finding life on other planets, then almost all fields of technology would be able to advance enormously. Space travel, medicine, communications, energy, food, and many other fields could benefit from exchanging information with another race of intelligent beings. This is just one of the great reasons to have a space program.

The study of the universe and of the Earth is imperative to mankind. Learning about Earth's weather patterns, studying the effects of global warming, sending probes into space to take a closer look at moons and planets far away, and searching for extraterrestrial life are all part of the space program. Low funding and job cuts are big problems for NASA and other agencies

involved, and many people think that the space program is a waste of time, resources, and man power. If the public could look at all of the progress mankind has made and all that has been learned and will be learned from studying space, then they should realize that every penny spent is worth it. Saving lives from a hurricane because a weather satellite showed that one was coming, or increasing public awareness of the green house effect and global warming in which people stop polluting the Earth and start cleaning up are examples of mankind's achievements. If the space program had more money to use, then maybe it could send a manned mission to Mars, or study a comet, or even build an international space station in orbit around Earth. The possibilities are there, the public just has to believe that they can gain from it.

Works Cited

Borenstein, Seth. "Repairs keep fleet grounded." Sentinel. 1995. Newsbank: Science (1995) :

fiche 8, grid F6.

Feldstein, Dan. "Overspending on redesign, safety cited." Houston Post. 1995. Newsbank:

Science (1995) : fiche 8, grid F11.

"Human Exploration and Development of Space (HEDS)." On-line. Available:

<http://www.osf.hq.nasa.gov/heds/>. Jan. 19, 1998.

Oliver, Patricia. "Office of Space Flight." On-line. Available: <http://www.osf.hq.nasa.gov/>.

Jan. 19, 1998.

Works Cited

Borenstein, Seth. "Repairs keep fleet grounded." Sentinel. 1995. Newsbank: Science (1995) :
fiche 8, grid F6.

Feldstein, Dan. "Overspending on redesign, safety cited." Houston Post. 1995. Newsbank:
Science (1995) : fiche 8, grid F11.

"Human Exploration and Development of Space (HEDS)." On-line. Available:

<http://www.osf.hq.nasa.gov/heds/>. 1/19/98

Oliver, Patricia. "Office of Space Flight." On-line. Available: <http://www.osf.hq.nasa.gov/>.
1/19/98.

Eric Harris
9\15\95
Period 6

In "The Sentimentality of William Tavner," the author uses direct and indirect characterization to develop the static and dynamic characters William and Hester Tavner. Direct characterization is when the author introduces a character and tells you about him. An example of direct characterization for William Tavner is that he is the most prosperous farmer and that he sets good examples for the kids. Hester is a strong woman and she is direct and to the point. Indirect characterization is when the author shows you the character and lets you figure out the details. An example of indirect characterization for William is that he is a quiet person and goes to church a lot. Furthermore, Hester spends her money foolishly so was probably wealthy and spoiled when she grew up. She also pouts when she is angry. A static character is someone who does not change in a story. William was a static character because in the beginning he didn't care if his wife was angry or mad and he is still like that in the end. A dynamic character is someone who changes because of a conflict in a story. Hester was a static character because she was spoiled and was not a very good mother in the beginning. Although she was smarter on how she spent her money and was a better mother in the end. I discussed how the author used direct and indirect characterization to develop the static and dynamic characters William and Hester Tavner in "The Sentimentality Of William Tavner".

Similarities between Of Mice and
Men and Grapes of Wrath.

By

Eric Harris

Period 1

Mrs. Caruthers

1\28\97

There are many similarities between John Steinbeck's two books, Of Mice and Men and Grapes of Wrath. Some similarities are between characters, and others are between settings. One example is how Steinbeck had a mentally challenged person in each book. Lennie and Noah, and not only was their mental state the same, but they also had a dream of living off the land. Lennie wanted his farm and rabbits, and Noah wanted to be alone and fish. Another example is Al and Candy. Al had a dream to go off and get married, and live happily ever after. Candy also had a dream, he wanted to go off and live on a farm and be happy for the rest of his life. Al was also like Curley's wife. Al would go around looking for women to date and be with. Curley's wife also went around flirting with men.

An example of similarity between settings is the time frame these two stories took place. Both stories took place during the Great Depression. Another example is that in both stories, the main characters were looking for work. The characters in both stories were also poor and had very little friends. One last example of a similarity between the two books is this: In both stories, near the end, the main and most productive character leaves the story, leaving the other characters to be on their own. Lennie was killed and George was alone at the end of Mice and Men. And Tom was forced to leave for fear of being arrested. Therefore he left his family at the end of Grapes of Wrath. There were many similarities between John Steinbeck's two books. Some were between characters and others were between settings and the plot.

st p d

NEW SOUTH WALES POST

December 15, 1873

Possible Time Travel

A 13 year-old girl by the name of Abigail Kirk claims she was brought back in time for an unknown reason. She states it happened while she was watching some kids playing a game. Then she heard the "Town Hall clock" start chiming and then she found herself in the middle of the street facing a cabby. She was about to be trampled by the horses but a girl named Beatie Bow pushed her out of the way.

13 year-old Falls For 18 year-old

Abigail Kirk (13 years-old) is in love with former soldier Judah Bow. She says he has the most beautiful smile she has ever seen.

Daily Interview

Today we are with Abigail Kirk. Abigail, tell us about this "time travel" incident.

Abigail: Well, I was just watching some kids play a game and then I heard the Town Hall clock start ringing. After that I found myself in the middle of the road.

NSWP: Did this happen quickly or did it take a while?

Abigail: It happened very fast.

NSWP: How did you feel when you saw this new world? And what did you do?

Abigail: I felt stunned and lost. And uh... I was in the middle of the street facing an on-coming cabby. Then this girl named Beatie Bow saved me. After that she ran off but I ran after her to ask her what was going on and where am I.

ENTERTAINMENT

Tonight at ST. Joseph's
Theater: THE LIFE OF THE
QUEEN.

Tomorrow night at 5 o'clock:
KING ARTHUR.

CLASSIFIED ADS:

Cabby, new, includes 2 horses
and silk curtains. 20 pence.

Wedding Dress, Brand new,
white with antique lace veil. 2
pence

Suit: well-tailored; durable.

Horse, Black and brown, 1
year old, very strong. 2 pence.

Cabby wheels, 1 pence per
wheel.

Potatoes: 20 pounds for 1
bushel

Boat: small schooner: 100
pence

Boat ride to America: 1 month
ride to America: 5 pence.

WANT ADS:

Stableboy: 6 days a week; 1
pence per month

Cook: 7 days a week; 1 pence
per week

Live-in maid: must be good
with children: must be good at
house-cleaning: 1 Sunday a
month off: 2 pence per week

Live-in butler: references
required: 2 pence per week

Live-in gardener: must be an
expert on how to plant flowers
and vegetables: 1 pence per
week

Math Tutor: 5 days a week; 1
pence per week

Seamstress: sew clothes for
children 10-15 years old: must
be skilled in sewing and
knitting

The North and South were mad, they were mad you see, they were mad over slavery. The North had found many reasons to be mad, not glad, mad, mad, mad! Like Uncle Tom's Cabin, for one reason to see, to be mad over slavery. Uncle Tom's Cabin was a story of slaves in the South, but not a happy story, as you will soon find out. The North grew angry, angry even more! The South exclaimed, "You stay out of our business, you stay out and keep out!" But the North said back, "You're still part of the United States! So don't begin to shout!" Then came the Dred Scott case verdict. Mr. Scott was a slave, even though he was freed freely from slavery. After he went North, the South soon sent for him to be returned, because the South had said, "Return him now, or he'll soon be dead!" According to them, slaves were property, not people. They had no civil rights, they were not equal. They must be returned, or face death the South burned. Then, in 1860, Mr. Abraham Lincoln was elected president. This election stirred the South up a bit, and soon the Southern states began to quit. You see, Lincoln was a republican, and the South was democratic. The Southerners were faced with great bias and Northern greed, so soon they were forced to succeed. First came South Carolina. Tennessee, Arkansas, and Texas soon followed along. Plus Louisiana, Mississippi, Alabama, Georgia, Florida, North Carolina, and Virginia came out of the Union just like the others. Now they were all brothers. Thus, the North and South finally divided. Soon after the divided, their armies collided. Soon Lincoln ordered Northern troops to begin a bombing at Fort Sumter, a Southern military fort. The bombardment lasted for quite some time, but when it was over fort was gone by the Northern bomb.

"Guilty"

We chose the song "Guilty" by Gravity Kills to relate to the play The Tempest. This song can be related to the entire play in several ways with many characters. We also chose this song because it represents our personal views and ideas on some of the themes and scenes in the play.

The Tempest is a tragic comedy by William Shakespeare. It is the story of a warlock, Prospero, that was banished from his home onto an island with only his daughter, a native, and a spirit of the island to keep him company. Eventually, those who wronged him were brought to the island by a magical storm that stranded them there. As the story unfolded, Prospero got his revenge/justice on the ones who wronged him and made peace with all.

Certain lines in the song relate to characters in the play. Miranda and Prospero are two examples. *"I'll tell you something, something new, you're hearing nothing, nothing true,"* relates to when Prospero is telling his daughter, Miranda, about society and people. This shows the relationship between Prospero and his daughter is like teacher and pupil. Whatever Prospero tells Miranda is considered by her to be true and valid. This shows that Miranda is very naive, pure, and untouched by society.

"You're killing me, I'm killing you, and I'm guilty too," can be related to Prospero and Alonso. Their relationship is one that is based on the "eye for an eye" principle in that Alonso banished Prospero to the island and, in revenge, Prospero made Alonso believe that his son was dead. In the end they both feel guilty for what they have done.

"1-2-3, I found you out so easily, 1-2-3, I found in you what I found in me," can be related to Prospero's experiences with Trinculo and Stephano. Trinculo and Stephano had a plot to take over the island. However, it was easily discovered by Prospero. Prospero believed that

they were evil and then plotted against them with an equally heinous plan.

“The time is wrong, the time is right--be careful who you kill tonight, and I'm melting, and I'm melting, and I'm melting, and I'm melting, and I'm melting in you.” This line relates both to Trinculo and Stephano and their plot against Prospero and to Prospero himself. Trinculo and Stephano were plotting to kill Prospero, but they needed to “be careful” since he was watching. Prospero could have been considered “melting” at the end of the story since his power was diminishing and he was completing his vengeance and justice missions.

“1 and 1 and 1 makes 3, 1 and 1 why don't you see,” can be associated with all of the magic used in the play. Like the tempest at the beginning of the story, things were not always as they appeared to be.

“I'm killing you, you're killing me, can't you set me free,” can be related to all of the conflicts in the play and the desire to resolve them. An example of this can be seen when Prospero wants to be on good terms with Alonso at the end of the play.

“Inside out I can't describe it, what you do to me, inside out, I can not hide it looking right through me,” can be associated with Ferdinands' love for Miranda. They are obviously in love, and are hiding nothing from each other.

“Now I've reached the living end, pointing fingers to defend.” This can be associated with the scene in which Antonio and Sebastian were about to kill Alonso while he slept. Alonso awoke and the two made up a quick excuse that they heard a noise and that is why their swords were drawn.

The song, “Guilty” represents the play, The Tempest, in numerous ways. It also portrays our personal views on themes, scenes, and conflicts that occurred in the play.

It was Himmler's master stroke that he succeeded in indoctrinating the SS with an apocalyptic 'idealism' beyond all guilt and responsibility, which rationalized mass murder as a form of martyrdom and harshness towards oneself. Nowhere was this more apparent than in Himmler's notorious speech on 4 October 1943 to the SS Group Leaders in Poznan.

'One principle must be absolute for the SS man: we must be honest, decent, loyal, and comradely to members of our own blood and to no one else. What happens to the Russians, what happens to the Czechs, is a matter of utter indifference to me. Such good blood of our own kind as there may be among the nations we shall acquire for ourselves, if necessary by taking away the children and bringing them up among us. Whether the other peoples live in comfort or perish of hunger interests me only in so far as we need them as slaves for our Kultur. Whether or not 10,000 Russian women collapse from exhaustion while digging a tank ditch interests me only in so far as the tank ditch is completed for Germany. We shall never be rough or heartless where it is not necessary; that is clear. We Germans, who are the only people in the world who have a decent attitude to animals, will also adopt a decent attitude to these human animals, but it is a crime against our own blood to worry about them and to bring them ideals. I shall speak to you here with all frankness of a very grave matter. Among ourselves it should be mentioned quite frankly, and yet we will never speak of it publicly. I mean the evacuation of the Jews, the extermination of the Jewish people. . . Most of you know what it means to see a hundred corpses lying together, five hundred, or a thousand. To have stuck it out and at the same time - apart from exceptions caused by human weakness - to have remained decent fellows, that is what has made us hard. This is a page of glory in our history which has never been written and shall never be written.'

Third Reich Acronyms, Etc. Info

NSDAP- National Socialist German Workers' Party
(Nationalsozialistische deutsche Arbeiter Partei)- The Nazi Party.

SS-Schutzstaffel (Protective Squads)- An elite paramilitary organization, formed in 1923, that began as a small group of bodyguards protecting the führer and developed into a party police force, a terrorist Reich police force, and a regular army within the army (Waffen-SS). The SS was a huge economic conglomerate that reached into German businesses, and it was also to an extent a gigantic murder machine that supervised a far-flung system of concentration camps in which people were tortured and annihilated. Under Heinrich Himmler, the SS became a state within a state, and its blackshirted members formed a tight-knit fraternity of racial true believers.

HJ-Hitlerjugend (Hitler Youth)- A youth organization of the NSDAP that forcibly amalgamated all youth groups in the Third Reich. Under the leadership of Baldur von Schirach, the HJ encompassed: the Deutsches Junkvolk (German Young Folk), who were the ten- to fourteen-year-olds; the Jungmädelsbund (League of Young Girls), girls aged 10 to 14; Bund deutscher Mädel (League of German Girls) and the HJ of 15 to 18 year-olds.

DAF- Deutsche Arbeitfront (German Labor Front)- Labor organization, sponsored by the National Socialists, that replaced the various labor unions of the Weimar Republic. Headed by Robert Ley, the DAF encompassed all of German labor, reaching a membership of more than twenty million. Its function was to bring about a lasting harmony between contending socioeconomic interest groups and to protect the rights of labor. It provided financial assistance to workers, set wages, and used its funds to improve the lives of German workers. Operating with a large budget, the DAF also developed various branches such as the Strength through Joy (Kraft durch

Freude) movement, which provided holidays to workers at inexpensive rates, and the Beauty of Labor (Schönheit der Arbeit) office, which tried to improve working conditions in plants and factories.

OT-Organization Todt- The primary building (construction, architecture, etc.)arm of the Third Reich.

NSKK-Nationalsozialistisches Kraftfahrkorps- The transportation arm of the Nazi Party.

NSFK-Nationalsozialistisches Fliegerkorps- The group that dealt with aviation matters for the Third Reich.

Afrika Korps-The various military formations sent by Hitler to aid the Italians in N. Africa. Under the command of General Rommel since Feb. 1941, the Afrika Korps fought valiant battles against the British and later against combined Anglo-America forces, but was decisively beaten by the spring of 1943.

Aktion Reinhard-Code name for the annihilation of Jews in the Polish territory administered by the Nazis. The operation was named in "honor" of SD chief Reinhard Heydrich, who was assassinated in Prague on May 27, 1942.

Aktion T4-Code name for the actions taken in the euthanasia program that led to the killing of one hundred thousand "lives not worth living" (mentally retarded men, women, and children). It was named after the relevant government department of the Reich chancellery located on Tiergarten Strasse 4 in Berlin.

Anschluss- The annexation of Austria by the Nazis in February 1938 and its incorporation as a province (Ostmark) into the German Reich.

Barbarossa- Code name for the German attack on the Soviet Union on June 22, 1941.

BDM-Bund deutscher Mädel (League of German Girls). A subdivision of the Hitler Youth. The Hitler Youth had a male and female division. The latter was subdivided into the League of Young Girls (10-14) and the League of German Girls (15-18). {See HJ}

Berghof- Adolf Hitler's Bavarian home at the Obersalzberg, NE of Berchtesgarden.

Blut and Boden- (Blood and Soil)- A term used to describe the fundamental Nazi belief that a healthy nation presupposes a people of common blood living on its own soil. The overuse of the term by Nazi ideologues prompted many Germans to refer to such blood and soil propaganda as "Blubo."

Dachau- The site of the first National Socialist concentration camp located about 10 miles NW of Munich. Opened in March 1933, it housed a variety of prisoners- Socialists, Communists, Jews, Gypsies, homosexuals- who were held in "protective custody." The camp expanded steadily and became one of the most notorious camps in Germany. During WWII the number of inmates grew to about seventeen thousand, some of them being used for cruel medical experiments.

Einsatzgruppen- Special battalion-sized mobile units of security police and SD officials that conducted police and terroristic actions behind and alongside the regular German army. During the Russian campaign four *Einsatzgruppen* were attached to Army Group North, Center, South, and the Eleventh Army. Their functions were to round up Communist functionaries, "Asiatic inferiors," and Jews and herd them into concentration camps or conduct brutal liquidations on the spot. It is estimated that these killer troops murdered close to one million people, mostly Jews, in mass executions and later helped to kill five million additional victims in annihilation camps.

Endlösung- (final solution)- Euphemistic code word for the "final solution of the Jewish Question," or the program involving the annihilation of six million Jews.

Führer-(leader)- Term chosen by the Nazi Party and later by all German authorities to describe their supreme leader, Adolf Hitler.

Führerprinzip- (leadership principle)-Antidemocratic belief that efficiency in government or businesses can only be achieved when leaders (führers) are fully empowered to do what they are

assigned to do by their immediate supervisors. Only the highest führer is responsible to the people through plebiscitarian measures, but otherwise delegates strong führer power (*Führergewalt*) to his subordinates who, in turn, delegate it to their subordinates.

Gauleiter-(party district leader[s])- The highest ranking Nazi official below the *Reichsleiter*. Directly responsible to Hitler, the *Gauleiter* were in charge of all economic and political activities in their districts (*Gaue*). During the war, they were also responsible for civil defense. Many *Gauleiter* also served as *Reichsstatthalter*, or provincial governors, thus fusing state and party offices.

Gestapo-(Geheime Staatspolizei)- The terrorist police force developed out of the Prussian police department called "security police" (Sipo); it was greatly expanded under Göring's tutelage by his assistant Rudolf Diels. When Himmler coordinated all the police forces of Germany under his control in 1933-34, he also took charge of the Gestapo and transformed it into one of the most dreaded organizations of intimidation and terror. Putting Heydrich in charge, Himmler managed to detach the Gestapo from any effective control by constituted legal authorities. The primary mission of the Gestapo was to identify enemies of the state, put them into "protective custody" (*Schutzhaft*), use any methods deemed necessary to extract information, and consign such enemies to prison or concentration camps.

Kristallnacht- (Night of Crystals)- Refers to the night of Nov. 9-10, 1938, when the Nazis instigated widespread attacks on Jewish synagogues, businesses, and homes throughout Germany, on the pretext of this being retaliation for the assassination of Ernst vom Rath, secretary to the German legation in Paris, by a Jewish protestor, Herschel Grynszpan, whose parents along with many former Polish Jews in Germany were being forcibly evicted.

KZ-German abbreviation for *Konzentrationslager* or concentration camps.

Lebensborn-(Life Springs)- An SS organization, founded in 1935, that provided safe homes for women, married or unmarried, who had children by SS men. Located in out of the way places, these

homes also functioned as stud farms where suitable German women could mate with equally suitable SS "assistants of conception." By 1944 almost eleven thousand children were born in thirteen Life Springs homes. In addition, these homes served as conduits for Himmler's criminal program of kidnapping Aryan-type children in the eastern territories and finding adoptive parents for them in Germany.

Napolas-(National Political Institutes of Education)-Elite party schools designed to train future government leaders.

NSBO-(National Socialist Factory Cell Organization)- A proto-union wing of the NSDAP whose aim was to wage propaganda in business and industrial plants in order to win the workers over to National Socialism.

Obersalzberg- A one-thousand-meter mountain NE of Berchtesgarden on which Hitler constructed his private villa, the Berghof.

OKH-(Oberkommando des Heeres)-High Command of the Army.

OKL-(Oberkommando der Luftwaffe)-High Command of the Air Force.

OKM-(Oberkommando der Kriegsmarine)-High Command of the Navy.

Orpo-(*Ordnungspolizei*) Order Police- Police branch that had been separated by Himmler from the Gestapo and the criminal police. Led by Kurt Daluge, the order police forces handled routine business such as traffic, patrols, and other police matters in both city and rural areas. Some of the "order police" units, however, were involved in mass atrocities in Poland and Russia, functioning like *Einsatzgruppen*.

RAD-Reichsarbeitsdienst (State Labor Service)- The Third Reich's equivalent to the Civilian Conservation Corps in the U.S. The two groups were founded around the same time for similar reasons- widespread unemployment throughout the country, economic depression, etc. RAD did the same things CCC did, like working on

roads, bridges, and such. When RAD was first founded in 1931, it was called *Freiwilliger Arbeitsdienst (FAD)*, and taking part was optional. When the Nazis first came to power, the name was changed to *National Socialist Labor Service*, and finally in 1934 it was altered to the final RAD, and participation was mandatory for certain age groups, who served for a set time period.

Reichsleiter-(Reich Leader)- The highest functionary in the Nazi Party, who exercised sweeping powers in his particular field. Appointed by Hitler, the *Reichsleiter* formed the highest level of the party, collectively called the *Reichsleitung*.

Reichstatthalter-(Reich Governor)- Agent or commissioner of the Reich government who was responsible for supervising a state government. These officials were empowered to appoint and dismiss state officials and to monitor whether individual state governments were in compliance with the Reich government. Most Reich governors were also *Gauleiter* and thus directly responsible to Hitler.

RSHA-(*Reichssicherheitshauptamt*) Reich Main Security Office- The super security agency of the SS created on Sept. 27, 1939, and headed by Reinhard Heydrich.

RuSHA-(*Rasse und Siedlungshauptamt*) Main Office of Race and Settlement of the SS.

SA-*Sturmabteilung* (Storm Detachment)- Hitler's private army of brownshirted storm troopers who safeguarded Nazi meeting halls, served as bodyguards to party leaders, fought street battles with members of the opposition, and acted as political foot soldiers distributing leaflets, begging for donations, and pounding the pavement for votes in support of the *führer*.

SD-(*Sicherheitsdienst*) Security Service- The intelligence service of the SS headed by Reinhard Heydrich. Its function was to discover the enemies of National Socialism and ideally arrest them before they had done anything wrong. Mushrooming into a grotesque bureaucracy of professionals, informants, and sadists, this terroristic police and "thought control" agency became not only an instrument of

totalitarian control but also one of the chief executive organs of the annihilation of Jews, Gypsies, Communists, and "Asiatic inferiors."

Sipo-(Sicherheitspolizei) Security Police- The security police force consisting of the Gestapo, the criminal police, and border police. Heydrich fused the Sipo with the SD when he became head of the Reich Main Security Office (RSHA).

Völkisch-(National- or ethnic-mindedness)- The term denotes a sense of Germanic ethnocentrism, cultivated by hosts of nationalistic movements before and after WWI. The Nazis represented the extreme expression of such tribal feelings and beliefs.

Völkischer Beobachter-(Ethnic/racial observer)-The official newspaper of the NSDAP, published with only a short interruption (1924) from 1919 to 1945 and edited throughout much of this period by Alfred Rosenberg.

Waffen-SS-(Armed SS)-Term used to describe the fighting arm of the SS. These were well-trained soldiers who fought on the front line of the most dangerous and vital battles of the war.

Wannsee Conference-(January 20, 1942)- A top-secret government conference, chaired by Heydrich and attended by major representatives involved in Jewish affairs (Eichmann, Stuckart, Luther, Freisler). It was during this conference that the technical means of bringing about the "final solution" to the Jewish question were discussed. The participants all agreed that the Jews represented a deadly biological health hazard and therefore had to be exterminated. The overall plan was to conduct a thorough sweep of Jews in the whole of Europe and transport them to the five major annihilation camps at Auschwitz, Belzec, Treblinka, Sobibor, and Majdanek. The Wannsee Conference was not the initiation of the final solution- that had already begun with mass shootings two years before- but a cooperative effort by which major state organizations agreed on common procedures of implementing the annihilation of European Jews.

Wehrmacht-(Armed Forces)- Term first used in 1935 to refer collectively to the branches of the German military- army, navy, and air force.

title pg

Return From the Stars

by: Stanislaw Lem

Novel Project

Eric Harris

period 5

Mr. Webb

4/27/98

JC-001-026752

The dream started out in my car. Dylan and me were trying to drive up a very steep hill to get to some event at the top. The road up was barely wide enough for 2 lanes of traffic and there were lots of other people that I recognized mostly from my bowling class trying to get up the hill also. The road was dirty, and the sides of the road sloped upward, so there wasn't much room at all. After lots of honking, yelling, aggressive driving and racing we made it to the top of the hill and parked my car. The next event I remember was struggling to get a bowling ball from an old rack sitting near the wall of a large, open room. If you have ever seen a movie called Demon Knight, it was like the main room in the hotel in that movie. After getting a ball, we ran up an open staircase. All the while people that I don't like in school were taunting us and I had a sense that things were starting to get very tense. At the top of the stairs we no longer had the bowling ball for some reason, and we looked over the railing and fights and brawls were starting downstairs. We ran over to the corner of the ledge and lots of gunfire broke out. We heard several people being shot and a lot of evil growling and yelling. We telepathically seemed to understand that we should stay where we were and wait for a SWAT team to arrive and help us out. A few times we peaked over the ledge and bullets shredded the railing and walls around us. The downstairs was empty, but had several shadows that seemed to have evil, demented inhabitants. After a long time of waiting a team of SWAT guys came in to the ledge from a door beside us and hurried us out of the building. Somehow we were on the ground level as we ran to a few cars and vans parked outside. We looked back and the SWAT team was being shot apart by gunfire. We knew that we had to rescue ourselves since the actual rescue-team was being destroyed. We hopped into a bulky white car and sped off down the hill, just as some sort of rocket flew out of the door of the building and nuked the SWAT van. Somehow I recalled some old sheriff guy in a bronco saying something about how he would escape the mountain roads by cutting across the switchbacks, no matter how steep they were. Next thing I knew we were in this bronco truck and we did a 180 on the dirt road and started to free fall down a few levels of the mountain. We landed on a road and sped off to a quiet little mountain town a few minutes down this road. After this my memory gets a little foggy, but I remember Dylan and I standing behind a large, senile mountain man who was buying a ton of groceries at a lodge. He left a sack of liquor and a pistol on the counter as he left, and I walked up and said something like to bad he forgot these, and paid for my things and left with all of the stuff. After that I can't remember much. And I am sure there were events in between some of those that I forgot as well.

TKmbtr1

The court case between Atticus and Mr. Ewell was over the rape of Mr. Ewells daughter, Mayella. The first witness called was Mr. Heck Tate, the sheriff. The second witness that was called was Mr. Robert Ewell. The third witness was Mayella Ewell and the fourth was Tom Robinson, the one being convicted of rape. The jury was made up of all white men.

He stated that on the night of November 21, he was just leaving his office when Mr. Ewell came running up and said that some nigger had raped his daughter. He went over to the Ewell place and found Mayella on the floor all beaten-up. He asked her who beat her up like that and she said that Tom Robinson had. He asked her if he raped her and she said yes. That was Mr. Gilmer's examination.

Atticus asked Mr. Tate if anybody called for a doctor and she said no. Because it was obvious what had happened. He said that she was beaten around the head and neck, and she had a bruise coming on her right eye. She also was bruised on her arms and on the back of her neck.

Mr. Robert Ewells' testimony was that he was coming from the woods caring a load of kindling when he heard Mayella screaming. He ran up to the window and said he saw Tom Robinson raping his Mayella. The window was about three feet off the ground. After that he ran around front and then Tom Robinson ran out the front door before him. When he got in he saw Mayella on the floor badly beaten and crying. Then he went and got Mr. Heck Tate.

Atticus' examination showed that the state had absolutely no physical evidence against the defendant because Mr. Tate nor Mr. Ewell went and got a doctor, so there was no proof that the rape ever actually happened. Mr. Ewell agreed with Mr. Tate's description of Mayella's injuries. Mr. Ewell was asked to write his name on an envelope, which he did with his left hand (showing that he is left-handed). And Mayella's injuries were on her right side. Indicating that Mr. Ewell could have committed the crime himself.

Miss Mayella Ewell was the next witness. Mr. Gilmer asked her what had happened on the night and she burst into tears. She said she was scared of Mr. Finch. Then she described what happened that night. She was sitting on her front porch when Tom Robinson came by and she asked him to bust up a chiffarobe for her. Then she went inside to get a nickel for him and when she turned around he grabbed her and started to beat her. After that he threw her on the ground and raped her. She was kicking and screaming as much as she could. The next thing she knew Mr. Ewell was over her yelling who did it then she remembers Mr. Tate taking her to the water bucket. That was all of Mr. Gilmer's examination.

When Atticus came up Mayella kept saying that he was making fun of her. She said she had seven brothers and sisters, she went to school for two-three years and can read and write. When asked if she had any friends she asked if Mr. Finch was making fun of her again. Then she was asked if she loved her father, she said yes and was going to say something else but stopped. Then she said that he never touched a hair on her head. After that she explained what had happened that night again with periodic long pauses. Then she identified the man who did it as Tom Robinson, the defendant. When

he stood his left arm was severely crippled from an accident as a kid. Then Atticus began to keep asking her questions, one after another. The last one asked if her father beat her up instead of Mr. Robinson but there was no answer. Then she said that if the men in the court room didn't want to do anything about her being raped then they are all a bunch of cowards. Then she burst into tears.

Tom Robinson, being the next witness, was the most important part in this trail and could have been the turning point in the trail. Robinson was asked about his previous encounter with the law. Him and another man were arrested for fighting. Robinson told Atticus about the incident and showed that he had nothing to hide. Then he told Atticus about the times before the rape when Mayella asked him to do work for her. She had invited him into the yard. Then on the night of November 21 she asked him to come inside and fix a hinge, when he turned around she kissed him and told him to kiss her back. He got scared and tried to get away, but she jumped on him and then blocked the door. And Mr. Ewell shouted from the window "You godamn whore I'll kill ya!" then Robinson ran out the front door. After that he said that he did a lot of chores for her because he felt sorry for her.

As Mr. Gilmer made his way to the witness stand Mr. Link Deas stood up and said that he never got one speck of trouble from him. Then Mr. Gilmer asked Tom Robinson about the misconduct he had with another colored man. Next he was asked if he could throw a women to the floor and choke her and he said probably. And again he was asked why he did all those chores for free and he replied because he felt sorry for her.

In conclusion, the final verdict was guilty and when he was going to prison he tried to escape and was shot 17 times. 1 time would have done it or even a warning, but they had to shoot him full of 17 bullets, because he was a "nigger". The verdict was full of racism and prejudice and was completely wrong. Tom Robinson couldn't have hit her on the right side because his left arm was crippled, and Mr. Ewell was left handed so he was the one who hit her.

Work cited page.

Ernest Hemingway. "A Train Trip" from *The Complete Short Stories of Ernest Hemingway*. Copyright © 1987 The Ernest Hemingway Foundation.

A Train Trip

One morning Jimmy's Dad awoke him, not knowing where they were going. They packed their things and headed for the boat to take to the train station.

Once on the train they talked quietly and eventually moved to the food cart. Jimmy's father showed him the criminals, and began a conversation with the detective and the criminals.

--Jimmy and Father are sitting at a lunch table, Prisoners sat across the aisle. Prisoners are handcuffed to cops, while eating lunch. Prisoner is arguing with cop. Jimmy and Father are watching.---

Kyle(prisoner)="Why don't you take them off?" (Prisoner jerks cop; cop spills coffee; jerks back and the prisoner gets hit in the lip. It happens again and the prisoner gets hit again in the face.)

Ryan(cop)="Had enough?"

Kyle= "Yes, I got plenty."

Ryan="You feel quieter now?"

Kyle="Very quiet, how do you feel?"

Ryan="Whipe your face, it's all bloody."

--All go back to the train--

Eric (father)="Did you see what happened at the table?"

Alex (son)="Yes"

Eric="Everything?"

Alex="I don't know"

Eric="What do you think the little man made the trouble for?"

Alex="I guess they wanted to make it uncomfortable so they would take the handcuffs off."

Eric="Did you see anything else?"

Alex="I saw him get hit three times in the face!"

Eric="Where did you watch when he hit the detective?"

Alex="I watched his face. I watched as the sergeant hit him."

Eric="While the sergeant hit him in the face with his right hand, the prisoner picked up a steel-bladed knife with his left hand and put it in his pocket."

Alex="I didn't see."

Eric="No, every man has two hands, Jimmy. At least to start with. You ought to watch both of them if you're going to see things."

--Jimmy sits, looking around---

Eric=Do you want to go to the smokeroom?

Alex=Yes.

Eric=Do you think we should tell the sergeant?

Alex=No.

Eric=Its an ethical problem.

Alex=Do you want to tell him?

Eric=No, besides a man is held innocent until proven guilty. He may have not killed that Italian.

Alex=Are they dope fiends?

Eric=I don't know whether they use dope or not, but using cocaine or morphine or heroin doesn't make people talk the way they talked."

Alex=What does?

Eric=I don't know what makes anybody talk the way they do.

Alex=Lets go up there.

--Go to smokeroom, They sat opposite the criminal(across the aisle). The prisoner wakes up and looks around a bit and then wakes up the sergeant.—

Kyle=Sergeant, I got to go to the can.

Ryan=Not now.—Goes back to sleep—

Kyle=Listen sergeant don't you ever have to go to the can?

Ryan=Not now!

Kyle=Sergeant, listen, I got to go to the can!

Ryan=ALRIGHT!

--Both go to the can, make a quick glance at Eric and Alex, and boy follows.—

Eric=Go ahead son, if you want to follow.

Kyle=I want to go in alone.

Ryan=No you don't.

Kyle=Go on, let me go in alone.

Ryan=NO!

Kyle=Why not you can keep the door locked!

Ryan=I won't take them off!

Kyle=Come on let me go in alone.

Ryan=We'll take a look.

--They both go in and the door shuts. The boy is outside and opposite the toilet door. He hears talking inside. The handle turns but stops short and something falls against the door and then the floor. Jimmy sees blood coming out from under the door and runs back to Father.—

Alex=Father there's blood coming out from under the closet!

Eric=Sit down.

Narrator=The sergeant was stabbed but did survive. The prisoner escaped by going out a window.

tularecito

Tularecito

by

Eric Harris

Period 1

Mrs. Caruthers

1/10/97

Tularecito did not deserve to be put away in the insane asylum. He just needed to be taught to control his anger. Society needs to treat extremely talented people like Tularecito much better. All they need is more time to learn what is right and wrong and what is acceptable in society. Putting people in an insane asylum is not the only way to deal with gifted people like Tularecito. Love and care is the only way.

JC-001-026763

weisses

Du auf dem Schulhof

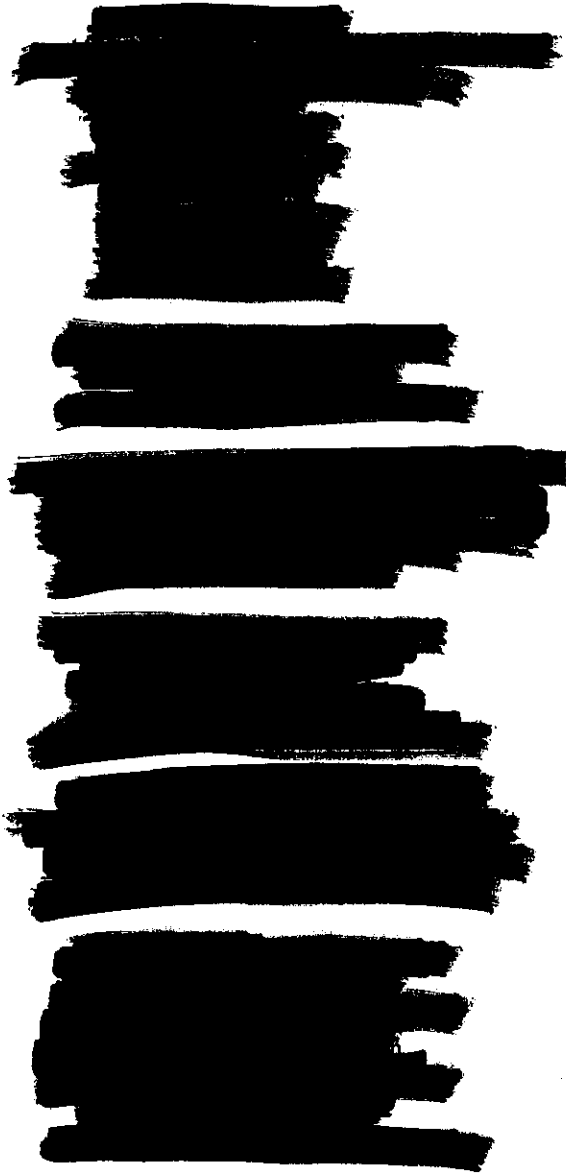

NEW WEAPONS OF WAR
by: Eric Harris

Many new weapons of war have been made and put to use. The British and French are using tanks. These tanks are large, metal trucks that move on treads instead of wheels. Unfortunately, these tanks are not very useful. They mostly just protect advancing troops in the front lines.

The most awful weapon introduced in this Great War is poison gas. This gas was first used by the Germans but is now used widely on both the Allies side and the Central Powers side. This gas is designed to burn eyes, destroy lungs, or just plain kill the opposing force. Usually used in the trench warfare areas, this gas can cause death to large numbers of soldiers. Most troops have protective clothing and gas masks made to keep out poisonous gas and only let in breathable air. Sometimes, if the wind shifts during one of these gas attacks, the wrong side could be affected!

The absolute most deadly weapon on the front lines is the machine gun. These fully automatic machine guns can kill an entire line of troops in seconds. This gun is used almost everywhere. Artillery is the other big killer in the war. Constant barrages of shells is not an uncommon thing to see. If the explosion of the shell does not kill, then the shrapnel will certainly cause severe injury. Shrapnel are tiny bits of metal hurtling through the air after the shell explodes. The shrapnel will stick into the body and cause several wounds to the soldiers close by.

Airplanes are constantly becoming more and more useful in the war. At first airplanes were just a waste of time and resources, but now, airplanes can fly behind enemy lines and bomb installations! They are also used to locate bases, gun down other planes, or shoot at enemy troops.

Wilder Wein

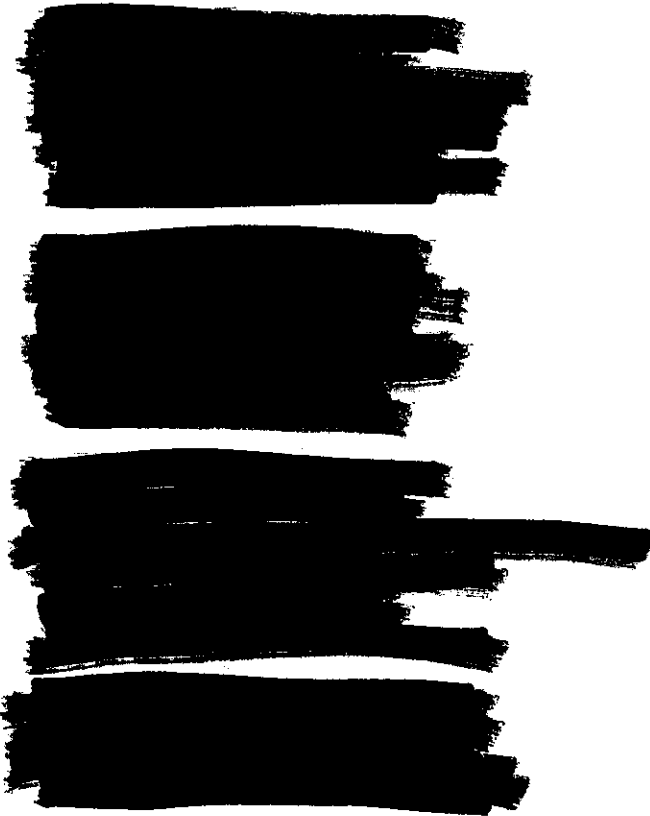

JC-001-026766

Work cited

Eric Harris
12/11/97

Works cited

Centers For Disease Control. "Weapon Carrying Among High School Students." Morbidity and
Morality Weekly Report. Vol. 40 No. 40. 11 Oct. 1991.

Gun Digest 1995, 49th Annual Edition. Northbrook, Il. DBI Books, Inc., 1994. 288.

Harrington, Donna. "Blown Away." The American School Board Journal. May, 1992. 22.

"Junk Guns." On-line. Available: www.gunfree.org/csgv/bsc_jun.htm. 9 Dec. 1997

Work

BOSNIA CITED WORK

- 1: Bosnia Herzegoveinas Relations with U.S.
V.7, *Congressonal Digest* Feb, 96 pg.36
- 2: Bosnias Harder Face by Keven Fedarko,
il V.147 Feb 19, 96 pg.40
- 3: Bosnias War Peoples Congress, Cliton toward own Battle by Carroll J. Doherty
il V.53 *Congressonal Qurterly Weekly Report* Jun 3, 95 pg.1587
- 4: An Anchant Hateraed by Michale Cussack
il V.126 *Scholastic Update* Mar 25, 94 pg. 18
- 5: A New Headach Aewaits by Carroll J. Doherty
Congressonal Qurterly Weekly Report Oct 8 , 94 pg. 287
- 6: Reversal of Fortunes by Mark Thompson
V. 144 *Time* Nov 14
- 7: The End of the Dream by Remy Ourdan
il V. 42 *World Press Reviwe* Jan 95 pg.29
- 8: Recunstructing Bosnia by Colin Solway
il V. 120 *U.S. News and World Report* Feb 5 , 96
- 9: U.S. Readies for Peace Talkes by Pat Towel
il V.53 *Congressonal Qurterly Weekly Report* Oct 28 , 95
- 10: The War in Bosnia Heritzagoviена
V.75 *Congressonal Digest* Feb 96 pg.36
- 11: Resturrecting Bosnia by Coline Solway
il V. 120 *U.S. News and World Report* Feb 5 , 96

WrK cited

Eric Harris
period 4.

Work cited.

"Cigarette taxes: The Straw to Break the Camel's Back." Rocky Mountain News. 12

November 1997: 7c. Online.

<http://www.rmtnews.health.ivl.com/bh/cigarettes.html>. 14 November 1997.

Harrity, Anne, and Ann Christiansen. Kids, Drugs, and Alcohol. Virginia: Betterway Books, 1987.

Noah, Timothy. "A Hit or Miss For Mr. Butts?" U.S. World and News Report. 30 June 1997. 22-23. NEWSBANK. CD-ROM. 1997.

Ortega, Mary. "Quit Smoking: The Agony of Defeat." Time 14 October 1996: 112-113.

Showalter, Nancy. Telephone Interview. 4 November 1997.

"Tobacco Industry." Microsoft Encarta CD-ROM. 1994. Microsoft Encarta CD-ROM. Online. Microsoft Corporation 1993.

"Tobacco Industry's Targeting of Youth, Minorities, and Women." Online.

<http://207.211.141/hs96/tobta.html>. 2 November 1997.

Zeus

Eric Harris
period 2
2\12\96

SIMILARITIES BETWEEN ZEUS AND I

The Greek god Zeus is most similar to me for many reasons. First, I try to settle problems in a mature, non-violent manner and so does Zeus. The second reason is that I often try to create new things. Therefore I am like Zeus because he is the ruler of the gods and creates new rules and animals. The next reason is that Zeus and I both like to be powerful and have some control over what is happening. I am always asking questions or double-checking myself to be sure I completely understand something so I am in control. We also both like to be leaders of large groups of people. I usually turn out to be a great leader just like Zeus. Zeus and I also get angry easily and punish people in unusual ways. For example, Prometheus stole the gift of fire and was then punished in an unusual manner. I usually punish people in unusual ways who steal or make me angry. The last reason I feel I am like the god Zeus is that we both are kind to other animals or people. All these reasons show why Zeus is the Greek god most similar to me.

JC-001-026770

first step 1
pioners

Eric Harris

period 1

2/18/97

Mrs. Caruthers

In the course of my life, I have moved to different houses or locations about six times. The last three times I have moved, I left behind some of the greatest friends I ever had. Since my father was a United States Air Force pilot, we had to move often. It is always hard to leave close friends behind. And since most of them live on the other side of the country, I will probably never see many of them again. A few I stay in touch with, but most I have lost. It is hard losing a friend, like Alexandra did in "O Pioneers." I will discuss the last three places I have lived in and the friends and memories I have left behind. I have lived in two homes in Oscoda, Michigan and one in Plattsburgh, New York.

The first home I lived in was located in a largely wooded area, so we didn't have many neighbors. Oscoda is a very, very small town. Of the three close neighbors I had, two of them had children my age. Every day we would play in the woods, or at our houses. We would make forts in the woods or make them out of snow, we would ride around on our bikes, or just explore the woods. It was probably the most fun I ever had in my childhood.

After living there for 3 years, we moved to live on the Air Force base. It was hard leaving my friends, especially my best friend. Even though we were still only a 10 minute drive away, we only saw each other maybe three times after that. We lived on the Air Force base for about half a year. I made friends there, some were good, but none were as good as my friends at my old house. Since we lived on the base, we had lots of neighbors. The houses in those old bases are like a lot of small condos. My friends and I had a lot of fun there, too. We still lived close to a large wooded area so we would travel around in there almost every day. We were all the same age too, so that made it even more fun.

But, as our family knew, we moved that summer. This time we moved to Plattsburgh, New York. It was real hard leaving my friends again. And that time I had to say goodbye to my first best friend for good. Plattsburgh is in upstate New York, along the shore of Lake Champlain. Home of the Lock Ness Monster's cousin, Champy. We lived on an Air Force base there too. It wasn't as cramped as the one in Oscoda, but it was still small. At first I had no friends there, even though there was many kids my age.

Then once school started, and even some help from my older brother, I had some friends. It took a while for our friendships to grow, but soon we were best friends and did everything together. Kris [REDACTED] the best friend I ever had, lived about 2 blocks away. Every day we would find something new to do. Some days we would walk along the shore of the lake and just mess around there. Sometimes we would look for old bullet shells from around 50 years ago and we even looked for Revolutionary War and Civil War era items. Kris once found the diary of a slave under some old Civil War barracks. We also found buttons, bullets, old bottles of whiskey or other liquor, and even some items from some very old train wreck. We had quite the collection of items, which most of them I still hold today. Sometimes Kris and I would play baseball (actually it was just home-run derby) with our friend from Norway, Jens. Jens was a good friend, he was the shiest person I had ever known and he wasn't used to our American customs, but he was always there. Kris and I made it our mission to make Jens into a normal American kid. We would go to the base gym almost every day and just mess around there. The gym was a very large facility, complete with full basketball court, racquetball courts, and a running track *above* the basketball court. We spent countless hours there, just hanging out and talking. Kris and I would ride our bikes all over the base too, we loved to ride bikes and the base was just full of interesting places. Soon news came that the base was going to be closed. This prompted a major campaign. There were large public parties held and everything. Then came Independence Day. The base had a large field in the center of all the housing areas, and every year they would hold a spectacular fireworks show. Kris, Jesse, and I (our other best friend) had the best seats in the house. We were about 100 feet away from the launch site of these fireworks. So they were exploding right over our heads. Then later that night there was a large party with bands playing and singing. A few weeks later, Kris moved to Georgia. This was hard to swallow. We had spent more time together than we did with our own families, and now he was gone. I still had Jesse though. And with what little time I had left in Plattsburgh, we did as much as we could together. Then, after my dad retired from the Air Force as a Major, we moved to Denver, Colorado. It was towards the end of the summer, so Jesse and I had spent some good times together. It was the hardest moving from Plattsburgh. I have the most memories from there. When I left Jesse, and when Kris left, I had a lot of feelings. I felt alone, lost, and even agitated that I had spent so much time with them and now I have to go because of something I can't stop. It doesn't take long to make a best friend, but it only takes 2 words to loose one. Those are, "We're moving." I still stay

in touch with Kris, and I try to with Jesse and some other friends from Plattsburgh. But there was a few that I didn't get phone numbers or addresses from. Such as my best friend in Oscoda.

Loosing a friend is almost the worst thing to happen to a person, especially in the childhood years. I have lived in many places, but the last three places have been the most fun and the greatest experiences of my childhood. Although memories stay with you, the actual friend doesn't. I have lost many great friends, and each and every time I lost one, I went through the worst days of my life. Since loosing a friend is something I have experienced many times, I know what Alexandra feels like in "O Pioneers." And it isn't something I would not like to feel for a long time.

Guns in School

I. In the past few weeks there has been news of several shootings in high schools. A student in Texas killed three fellow classmates and injured many more when he fired at a prayer group before school. This student had several other weapons with him when he was apprehended, showing how easy it was to bring so many weapons to school and not be noticed. Students who bring guns to school are hardly ever detected. This is shocking to most parents and even other students since it is just as easy to bring a loaded handgun to school as it is to bring a calculator. The problem of guns in school is a major one faced by many parents, teachers, and citizens these days. Solutions are hard to come by in such a situation because of how widespread the problem is and how different each school in each town can be. Students can get weapons into school too easily and they have too much access to weapons outside of school.

A. Weapons in school are hard to detect and students have ways of getting out of searches or other ways of detection.

1. One example of students avoiding detection is a 1990 survey conducted by the Centers For Disease Control (CDC) which found that one in 20 high school students carried a gun in school during the past month (CDC).
2. Students can use their backpacks, purses, or even projects to bring weapons into school.
3. Metal detectors can be avoided by using other school entrances.

B. Students have access to many weapons and can obtain a gun from many places.

1. The low price of junk guns (as low as 69 dollars) brings these guns within the economic reach of children (Gun Digest, 288).

2. "Junk Guns," also known as Saturday Night Specials, are handguns that are extremely small, inexpensive and typically poorly made (Junk Guns).
 - a. The fact that these guns are small and inexpensive implies that these "junk guns" can be found and purchased easily by students.
3. School security experts and law enforcement officials estimate that 80% of the firearms that students bring to school come from home, which shows where most students get their weapons. (Harrington 22).

Guns in schools are a growing problem in today's society. Every day the news broadcasts stories of students shooting students, or going on killing sprees, or even just bringing a gun to school. Students bring guns to school for many reasons. Some for protection, some for attacking, and even some to show off. However, a school is no place for a gun. Solutions for this problem are hard to come by and often too expensive for most schools to even consider, however metal detectors and more police officers are two very good solutions.

Metal detectors posted at entrances in schools can prevent guns from entering schools. That is a given fact. Although, the cost of these machines are rather high and some schools simply can not afford them. Tax payers and donations are other ways to form money to buy detectors, but some tax payers would not be happy with the prices. Several schools in the United States have metal detectors, and shootings still take place in the school. Students can be very resourceful, and can find ways to avoid the detectors. The idea of more police officers is a very good solution. However, this would also cost more money for the tax payers. The end result, in my opinion, is worth every penny spent.

Metal detectors and other forms of detectors are very good solutions. Once installed in all main entrances, students can simply walk through while trained officers can search suspicious

bags and backpacks if the alarm goes off. Students will be much more safe, but the fact of low morale is still present. One problem with metal detectors is that several school-related items are metal and would most likely set off the alarm. This leads to several searches that turn up nothing. This can cause long lines and be a hassle for students trying to get to class.

Police officers can discourage students from bringing weapons and can stop anyone who manages to get a weapon in the school. They are there to protect and serve, so students can go to them if they want to report someone with a gun or any other incident. More cops in schools is a great start to preventing more shootings in schools. On the other hand, the more cops in a school the more it begins to look like a prison. The community does not want it's schools looking like jail houses with the children as the prisoners. They are there to learn and, if students feel uncomfortable, that only leads to more problems. Drop-outs, grades, and student morale would all get worse with the presence of police, even though the cops are there for the students safety. Therefor, only a few cops should be assigned to schools at first. The schools should let the officers and the students get familiar with each other. This familiarity will help the morale of the student body.

More and more we hear of shooting sprees and rampages on the news. Some can be prevented, some can not. Almost any school shooting could have been prevented in some way or another, we just have to spend the necessary time and money to figure out how. Metal detectors and more police officers are only two good solutions. If tax payers can afford to do one or both of these solutions, then that is fantastic. If not, then the community needs to figure out other ways to keep guns out of schools. Students can not learn very well and be motivated if they know that someone in their classroom has a gun with them. In conclusion, metal detectors and more police officers are a great start to the fight against guns in school.

Jan 30

Eric Harris
Period 2, T-dog.
11/19/98

Everyday events can change a life significantly and we might not even be aware of it. Everything we do, say, and see and everything others do always will affect us, no matter what we think. Therefore, it is hard to say which event in my life has had the most serious, dramatic change. I do believe what happened on the last Friday night in January 1998 is the most significant event that has changed my life. My friend Dylan and I were driving around that night at about 9:00 PM with nothing to do. We decided to go to the a dirt parking lot off of deer creek canyon road to just kind of "hang out" to kill sometime. We were planning to check out some movies, and go home to my house and just spend the night there, just another weekend night. We arrived there, and there were 2 cars, a large white utility van and a small red truck, already parked there. We were the only ones there so we just walked around, broke some bottles we found there, lit off some fireworks, and just talked. Then we began thinking about breaking into this van. No one was around, we had a clear line of sight to anything coming and going, and the van was stuffed with electronic equipment. We thought there was no way we would get caught, and everything seemed so easy. So we got a rather large rock, broke the window and Dylan started removing items from the van while I waited in my car keeping a look out for incoming cars. After about 10 minutes I said "that's enough, let's go." So we left the scene and went up to an open space in the mountains. We were sure we had gotten away with it all, so we started reviewing what we had stolen. I got out of my car to put something in my trunk when a Jefferson County sheriff shined his rather bright flashlight into my eyes from the other side of my car. Right then I realized what a damn fool I was for what I did. He had been watching us for about 5 minutes, apparently he had seen us far away, parked his car down the road, and walked up behind my car without us noticing him. We told him everything, and we were arrested. We spent that entire night waiting for the cops to finish searching my car, waiting at the station and filling out forms and giving statements to the cops, explaining to my parents what we had done and why, and then going up to Golden to get "booked." After a very unique experience in a real live police station being a real live criminal, I had lots of time to think about what I did. Remorse put it lightly. I spent about 4 hours there, only about 15 minutes of that was I actually doing something, like giving them any and every imaginable way of taking my fingerprints, or taking my picture. Actually, mug shot would be a more appropriate word. I waited for the rest of the time. Their computer chose that moment to break down, so they put me into prison-type bathroom to wait. As I waited, I cried, I hurt, and I felt like hell. We got home at about 4:30 AM that morning. My parents lost all trust in me, and were completely disappointed beyond belief. April is when our court date finally came around, and we were both sentenced to 1 full year of diversion.. Which is a lesser charge since we plead guilty to all charges. So, the consequences of that night were; 1

JC-001-026778

Eric Harris
Period 2, T-dog.
11/19/98

year diversion which includes about 350 dollars worth of fines, a total of 4 full days of classes such as anger management and mother against drunk driving, 45 hours of community service, 2 months grounding, 120 dollar fine for getting my car back (it was impounded), and I am seeing a psychologist to help me with my anger problems. I am glad neither of us drink or do drugs, because that would have sky rocketed our already orbit-level consequences. My parents lost all respect and trust in me and I am still slowly regaining it. That experience showed me that no matter what crime you think of committing, you will get caught, that you must, absolutely must, think things through before you act, and that just because you can do something doesn't mean you should. To this day I still do not have a hard realistic reason why we broke into that car, but since we did, we have been set on a track that makes it mandatory for me to be a literal angel until March of '99. So that will hopefully keep me out of any trouble that I would have gotten into my senior year. Personally, I think that whole entire night was enough punishment for me. On the good side, I have had many new experiences that I am sure will help me with life as a result of being on diversion. So all in all, I guess it was a worth while punishment after all.

JC-001-026779

You Know what I Ha

YOU KNOW WHAT I HATE!!!!?

---SLOW PEOPLE!! You know those people who walk like a lifeguard on baywatch runs! Slow as molasses!
MOVE IT OR LOOSE IT PUNKS!

YOU KNOW WHAT I HATE!!!!?

---When there is a group of trendy punk like little smart asses standing in the middle of a hallway or walkway, and they are just STANDING there talking and blocking my way!!! Bloody snotty people think they are god almighty and can just stop and talk away wherever or whenever they please, learn some manners you stuck up people!!

YOU KNOW WHAT I HATE!!!!?

---When people dont watch where THEY ARE GOING! Then they plow into me and say "oops, sorry." or "watch it!" NNNYAAAA!!! Like it couldnt possibly be their fault that we collided. Oh, heaven forbid your holy graciousness being the cause of something baaaaad.....RRRRRR!!!!

YOU KNOW WHAT I LOVE!!!!?

---When some rich stuck up piece of s!@# white trash person gets in a car wreck with their brand new car!

YOU KNOW WHAT I LOVE!!!!?

---When some stupid retarded kid blows his damn hand off because he couldnt figure out that a lit fuse means that the firecracker is going to go off soon! HAHAHA!!

YOU KNOW WHAT I HATE!!!!?

---OOOOOOOOJAAAAAAAAAAAAAY!!!!!!!!!!!! GOD I F-ING HATE THAT WORTHLESS TRIAL!!! Who in their right feeeeeeRRIGIN mind would care about that trial??!? its not any different from any other murder trial! Tell those worthless reporters to get a life! And what the hell do we have to gain by watching that stupid trial anyway!?! Its not news! its a trial! not news! trail! Trialdoes not = news!

YOU KNOW WHAT ELSE I HATE!!!!?

---Jon binay however the flip you spell her spoiled name Ramsee!!!! We dont care! Good flipping riddens!!! What the flame do you expect if you flicking put your kid in all these beauty pagents when shes 4 years old!! Makes her look like a SLUUUUUUUUUUUT!!!!!!

YOU KNOW WHAT I HATE!!!!?

---STUPID PEOPLE!!! Why must so many people be so stupid!?!?

YOU KNOW WHAT I LOVE!!!!?

---Making fun of stupid people doing stupid things! Like one time when i was watching this freshman try to get on a computer that needed a password....he typed in the password.....and waited. The retard didnt press enter or any thing. He just waited. Then he started cussing at the computer saying it was screwed up. Then the freshman went and got a teacher and the flippin teacher could not figure out why it wasnt going anywhere!!! JESUS!! Personaly i think they should be smacked across the face a couple million times er so.....give or take 1.

YOU KNOW WHAT I LOVE!!!!?

---Natural SELECTION!!!!!!!!!!!! God damn its the best thing that ever happened to the Earth. Getting rid of all the stupid and weak organisms.....but its all natural!! YES! I wish the government would just take off every warning label. So then all the dumbasses would either severely hurt themselves or DIE! And boom, no more dumbasses. heh.

YOU KNOW WHAT I HATE!!!!?

---RUDE PEOPLE THAT CUT!!!!!! Why the flip cant you wait like every other human on earth does. If you cut, you are the following: Stuck up, self centered, selfish, lazy, impatient, rude, and.....damn i ran out of adjectives. anyway. Every flippin line i get into i end up having to wait a flaming hour when there WAS only me and 1 other person in the line! Then the asshole lets all his/her so called friends cut in behind em!

YOU KNOW WHAT I REALLY HATE!!!!?

---LIARS!!! OH GAWWWWWWD I HATE LIARS. And living in this neighborhood there is thousands of them!!! Why the flip must people lie so damn much! Especially about stupid things! Like "Yeah, i just bought 5 cases of M-80's in Oklahoma for about \$5. And they are legal there and everything. Yeah my parents buy most of my guns, every once in a while ill use my 4,000 dollar paycheck and buy a shotgun or 2. And my brand new hummer just broke down on the highway when i was going 250mph. Stupid cars." like that. now. what flaming part if any would a normal human being believe? And thats just one person!! Another BIG example is Brooks Brown(303-972-0602). Now, according to him, he has a 215 IQ, 5 other homes (2 in alaska, and 3 in Florida), 95mph fast ball(he is only 16), runs a mile in about 5 minutes, has an uncle thats the former head of all the armed forces and has access to.....Theee Button..., his other uncle is a multi-millionaire that lives in downtown detroit, and his neighbors are the chick that sang "r.e.s.p.e.c.t." and the lead singer of Aerosmith. And that same uncle owns 30% of the stock of that tylenol company, And his grandparents gives..GIVES...him about 1000 dollars for each month, and his other

JC-001-026780

Grandpa can blow up every house in America because all the houses have C-4 in the foundations. Again, according to Brook Brown. OK, when people lie like that, its not impressive, noone believes it, it sounds just plain stupid, and its a friggin waste of my time.

YOU KNOW WHAT I HATE!!!!?

---R rated movies on CABLE! My DOG can do a better damn editing job than those tards!!! For the sake of all television they can at least try to make it sound like actual words the person would say! If you have ever seen Aliens or Predator you'll know what I'm talking about.

YOU KNOW WHAT I HATE!!!!?

---Windows Keys!!!!

YOU KNOW WHAT I LOVE!!!!?

---WAREZ!!! Why pay when its free?

YOU KNOW WHAT I HATE!!!!?

---People who think they can forecast the weather!!! Then they think that everyone else will think that they are cool just because you said that we were gonna have a 4 foot blizzard starting today! Like just the other day, this punk i know was saying.. "Yeah tomorrow we are gonna get like, 2 feet of snow in just a few hours, They were saying its gonna be the biggest snow in ten years. Yeah. Itll be about -60 outside too." And that day we get an inch of snow and its 26 out.

YOU KNOW WHAT I HATE!!!!?

---Cuuuuuuuhntryyyyyyyyyy music!!!

YOU KNOW WHAT I LOVE!!!!?

---Zippo Lighters!!!!

YOU KNOW WHAT I HATE!!!!?

---People who say that wrestling is real!! now, im talking about the matches like hulk hogan or undertaker. If you think that these matches arent faked and that these guys are REALLY punching and breaking arms, then please mail me. I would love to know where you live so i can BOMB your fucking house and ACTUALLY BREAK YOUR ARMS!☺

YOU KNOW WHAT I HATE!!!!?

---YOUNG SMOKERS! they think they are so god damn cool with their big bad ciggarettes and their "sooo cool" attitude. I cant wait until they are about 25 and have to breathe through their friggin necks and talk with a computer hooked up to their formal-vocal cords.

YOU KNOW WHAT I HATE!!!!?

---PAYING FOR MY CAR INSURANCE!!!

YOU KNOW WHAT I LOVE!!!!?

---FREEDOM OF SPEEEECH!!!

YOU KNOW WHAT I HATE!!!!?

---Freedom of the press. I hate that part of the Bill of Rights.

YOU KNOW WHAT I HATE!!!!?

---People who are against the death penalty!!! i think the courts should flaming fry every convicted felon out there!

YOU KNOW WHAT I LOVE!!!!?

---SCHOOL!

YOU KNOW WHAT I HATE!!!!?

---SCHOOLWORK!

YOU KNOW WHAT I REALLY HATE!!!!?

---COMMERCIALS!!! OH GAWWD I HATE COMMERCIALS!!! The only ones i MIGHT like are previews and some car commercials. But jesus christ, all those Lotion, PERFUME, Makeup, JCPENNYS, Joslins, food, coffee, or advertisement commercials! Please! Destroy them all! never record another! They suck! They are only funny the first time! Think up other stuff! They suck! They are stupid! We get sick of them VERY FAST! VERY! VERY FAST!

YOU KNOW WHAT I HATE!!!!?

---TRENDS!!! I HATE trends! Like tommy hilfiger or mossimo or SKA or those little chapstick lip gloss lip cream CRAP that every freakin girl in middle and high school carries around! They are just so.....DAMN.....rrr.....RR... ANNOYING!!!! YAAAH!!! RRRRR!!!!

YOU KNOW WHAT I HATE!!!!?

---People who dont believe in personal hygiene. For the love of god. and for the sake of god, CLEAN UP! Frickin people with 2 inch fingernails and a whole frickin flower pot full of dirt under them and raggy hair or shirts stained to hell. Or people that just plain stink, and they dont do anything about it. Now, im not making fun of anyone if they cant help it, or afford it or anything like that, thats not their fault, but if your some kid drivin a ford explorer and have yellow teeth, then thats just plain unhuman.

YOU KNOW WHAT I HATE!!!!?

---People who use the same word over and over again! Like, "actually", or "shazame", or "nifty". Read a fuckin book or two, increase your vo-cab-u-lary ya f*ck*ng idiots.

YOU KNOW WHAT I HATE!!!!?

---People who try to impress me by TRYING to brag about the militaries weapons! Now, to some of you this might seem, wierd, but its happened. Like this, "dude, they just came out with this new chemical that can destroy denver only using a cubic inch of it. The military is keeping it all locked up because if it gets to close to water it explode, and the force would create a cresent earth, maaan." Yeah, right, bullshit, or like this, "Dude, the air force has tracked santa clause for like, 10 years now, he is real man. its all a cover up." or "The air force just made a plane that can bend light man, its completely invisible." now, this is just some of the shit i've heard. it makes me SICK. And they arent even in the frickin military nor do they know anyone that is even if it WAS true and like they would know about it! GAWD!! I HATE those PEOPLE!

YOU KNOW WHAT ELSE I HATE!!!!?

---People who THINK they are martial arts experts! They are all cocky and thinkin that they are all big and bad. saying bullshit like, "yeah if you snap your fingers right here the sound waves will melt the brain and youll die from your own brain poring out your ears." or "if you flick someone right here their arteries will burst and they will drown in their own blood." freakin hate it when they keep sayin "your own", like it would be someone elses!?!? then when these shitheads get in real fights the get their frickin asses wooped all over the place by some little girl.

YOU KNOW WHAT I HATE!!!!?

---STAR WARS FANS!!! GET A FaaaaaaRIGIN LIFE YOU BORING GEEEEEEKS!

YOU KNOW WHAT I HATE!!!!?

---RACISM!!! Anyone who hate blacks, asians, mexicans, or people from any other country or race just because they arent from here or are a different color...woopie freakin doo man. And that goes for black people too. I've seen people on Ricki Lake or Opra or whatever saying things like "white boy, whitie, you say dat cuz you be white, yea..you white people all du same, she be white, so she baaad, I bet he did dat stuff cuz he a white boy" allll that stuff just pisses me off to no end. It is possible for BLACKS to be RACIST too ya KNOW.....people who think that should be drug out into the street, have their arms ripped off, be burnt shut at the stumps, then have every person of the race that YOU hate come out and beat the crap out of you. You people are the scum of society and arent worth a damn piece of worm crap. You all are trash. And dont let me catch you making fun of someone just because they are a different color because i will come in and break your f*ck*ng legs with a plastic spoon. i dont care how long it takes! and thats both legs mind you.

YOU KNOW WHAT I HATE!!!!?

---THOSE FREAKIN ADVERTISING OR CHARITY CALLS! People saying "Hi, im not selling anything but"----good, now shut the flip up and go get a real job!---well! you are so rude!"---damn strait and if you dont get off my line ill come down to your building and shove that phone list up your arse and take the phone and shove it up your boss's arse! "click" heeheehee, that would be cool.

YOU KNOW WHAT I HATE!!!!?

---When people mispronounce words! and they dont even know it to. like acrosT, or eXspresso, pacific (specific), or 2 pAck. learn to speak correctly you morons.

YOU KNOW WHAT I HATE!!!!?

When people drive really slow in the fast lane!!! GOD!!! Those people do NOT...NOT..NOT..NOT know how to drive!! Anyone who knows anything about driving knows that if you are passing someone or going really really really fast, you should stay in the slow lane!! Anyone caught doing that should be sent to every driving class available for a flaming year!

YOU KNOW WHAT I HATE!!!!?

THE "W.B." network!!!! OH JESUS MARY MOTHER OF GOD ALMIGHTY I HATE THAT CHANNEL WITH ALL MY HEART AND SOUL. Their stupid "dubba dubba hey dubba hoe dubba B dubba boo dubba foo dubba dubba wubba lubba HEY dubba hoe dubba" CRAP!! Are they purposely doing that just to piss me off!!!!???

JESUUUUS!!!

YOU KNOW WHAT I HATE!!!!?

Basketball!

YOU KNOW WHAT I HATE!!!!?

PUFFY DADDY OR PUFFY COMBS OR PUFFY SMALLS OR WHATEVER THE HELL HIS NAME IS!! I hate that guy!!!! Why doesnt anyone "bust a cap" in his ass??? He cant even rap worth a damn! All his songs are like "mmm yeah huh Uu Uu Uu yeyah mgmmmbmm yeeeyahh jijjeya Uoo UU uu.....mmtmdlkg mmmmmmtgmmmm yaaahh.... Uu..." and stuff. I HATE THAT GUY!!!

YOU KNOW WHAT I HATE!!!!?

PEOPLE WHO ARE MEAN TO ANIMALS!!!!!! The only promise I make in this whole page is this: if I ever see anyone on god's green earth harm a dog or be mean or unkind to any mammal, I will SEVERELY hurt you, I swear to god, I swear on my computer, on my car, on my fucking LIFE I will hurt you.

YOU KNOW WHAT I LOVE!!!!?

Driving FAST!!

YOU KNOW WHAT I HATE!!!!?

SKA!

YOU KNOW WHAT I LOVE!!!!?

Good, fast, hard, strong, pounding TECHNO!! Such as KMFDM, PRODIGY, ORBITAL, RAMMSTEIN, and such.

YOU KNOW WHAT I HATE!!!!?

RAPPERS AND THEIR OH SO SMOOTH COOL SUAVE RAPPER ATTITUDE!!!!!!

YOU KNOW WHAT I HATE!!!!?

RAP VIDEOS!!! Every geeewd damn one of them is the same! 5 chicks all with color coordinated outfits and little nylon jackets and spandex pants dancing around while some dorky rapper moans and groan around and drives a fancy car and waves his arms around acting like a freakin DORK!

YOU KNOW WHAT I HATE!!!!?

HOMOSEXUALS!! It is just plain WRONG.

People who tell me what I think or what I do or what I should say! Sometimes its ok, like if its a psychiatrist or something, but if its just some other "dude" at school telling me I shouldn't think something or some teacher telling me I cant go down some hallway, then I say FUCK YOU I do what ever the figgide flame I want!!

YOU KNOW WHAT I HATE!!!!?

G rated MOVIES!! Like the Lion King or HERCULES or Warriors of Virtue. I don't care who they are made for I DON'T LIKE THEM!

YOU KNOW WHAT I LOVE!!!!?

FREEDOM!

YOU KNOW WHAT I HATE!!!!?

U.S.A.'s La femme Nikita. Stupidest damn show I have ever seen. Little swat team navy seals wanna be dorks.

YOU KNOW WHAT I LOVE!!!!?

PUNCHING THINGS!

YOU KNOW WHAT I HATE!!!!?

HANSON! Little pansy ass WUSSES!! Girls like them cause they think they're boys and Boys like them cause they think they're GIRLS!!

YOU KNOW WHAT I HATE!!!!?

IRAQ!! Nuke em all!!

YOU KNOW WHAT I LOVE!!!!?

When I catch someone doing something that i told em not too do! Then im just like....now now, how should I kick your ass...hmmm.

Freshman!!! They are freakin everywhere and they are pissin me the hell off!
 Religions!!! Jesus is dead...get over it!!! the bible is just a freakin BOOK!! I would sooner burn to death than say
 I worship some egotistical god!!
 Retards!!! They are a waste of time and money and effort and energy and space and lots of other stuff too! They
 need to DIE!!
 Puff freakin daddy!!! He sucks! He can absolutely NOT rap!!! No one can, because rap is GAY
 Missy elliot!! Stupid fat ugly barrel of LARD!
 Lil kim!!! Another stupid fat ugly barrel of LARD!!
 Mace!! Another wannabe star who THINKS he can rap but really CAAANT!
 Masta P another rapper! Too many rappers!!!
 will smith!! God damn did he ever sell out!! He was cool, but then he started doing these videos again!
 RAP VIDEOS!! They are all the same!! 5 stupid cheerleaders in color coordinated nylon outfits dancing around
 in front of a curved orblike camera with a dumbass guy walkin around swingin his arms sayin "uh huh yeyah werd
 up you know what im sayin uh huh mmmhm yeya babey"
 hanson!!! Stupid little possessors who think they are cool! I still think atleast one of them is a girl!!
 GAP! God damn trends!! Why are they sooo original!! If its made in a factory its not very freakin original!!
 TOMMY HILFIGER!! They remind of the nazis by how that damn hilfiger name is all over the place just like the
 swastika! Think about that one!!
 OLD NAVY!! What the hell is wrong with those commercials?? Are they supposed to be that stupid??!
 AMBERCROMBE and futch!!! Yet another yuppie dumbass wannabe trend!!
 edie bower!! More trends!!
 SKA!! People who like SKA give the rest of the human race a bad name!! They think they are soooo cool with
 their pot and flowers and condom hats and big baggy pants and wallet chains and sandals and CRAP!!
 skatelites
 five iron frenzy
 skanking
 dancing!! Have you ever looked at people dancing and seen how utterly stuupid they look!! Doesnt that give you a
 clue about yourself dancing!!
 less than jake
 pie tasters
 bills dog verne!! First of all the name itself is retarded, and second of all the band SUCKS!!
 real big fish
 aquabats
 blink 182
 311
 cops! Stupid law enforcing people!!!
 LOVE----beef jerky!!
 Politics!!
 Clinton jokes!! For gods sake the joke is over so just shut up about him!!!
 Foreigners!! Get out of my country!! Or atleast learn english and take a few driving classes!!!
 American furniture warehouse!! With their stupid commercials with that freakin annoying old man and his uglyass
 daughter and his uglier ass granddaughter and all those god damn wild animals crawlin around on their furniture!!!

Just A Day

I seem to remember our fishing trips well. They were always preempted, never extemporaneously brought out by my father the night before his intended day of relaxation. How could one look forward to a trip if they did not know about it? Go to bed early, we have to get up at 5! Under normal circumstances, this would bring out a barrage of arguments & pouting, but going fishing was not an everyday thing. This was a good thing, as opposed to getting up for school or some other bulls*\$t. I would wake up to black skies & coffee bean aromas making their way around the house. I never liked coffee, but I loved the smell. I would dine on fancy breakfast cuisine, otherwise known as Cocoa Puffs. My brother would already be up, trying to impress our father by forcing down the coffee he hadn't grown to like yet. I always remember my brother trying to impress everyone, and myself thinking what a waste of time that would be. I would go to the garage & get my fishing tackle together, & throw it in the back of our '74 Ram. By then my brother & father would have all the food & coolers ready, & they would be packing, ready to go. The drives up to the mountains were always peaceful, a certain halcyon hibernating within the tall peaks & the armies of pine trees. It seemed back then that when the world changed, these mountains would never move. They would remain at peace with themselves, and with anyone who would respect them. We arrived at the lake, but I don't remember what the name of it is. The lake is almost vacant, except for a few repulsive, suburbanite a\$\$holes. I never liked those kind of people, they always seemed to ruin the serenity of the lake. I loved the water. I never went swimming, but the water was an escape in itself. Every so often, the waves would form a small pattern, & change current in an odd shape. I would always cast into those spots, thinking that the fish were more attracted to these parts of the water. Time to bait. I never liked salmon eggs, too much gooey crap that gets on your fingers. Instead, I went with a lour, even though this was a lake. I knew I would have to use eggs if I wanted any fish, but that didn't matter at the time. Cast, Reel, etc. countless times, and my mind would wander to wherever it would want to go. Time seemed to stop when I was fishing. The lake, the mountains, the trees, all the wildlife s\$*t that people seemed to take for granted, was here. Now. It was if their presence was necessary for me to be content. Time to go!. Done. Back to society. No regrets, though. Nature shared the secret serenity with someone who was actually observant enough to notice. Sucks for everyone else.

JC-001-026785

Name: ZAP.JPG
Dimensions: 756 x 504 pixels

Name: VAMP.JPG
Dimensions: 424 x 283 pixels

JC-001-026787

Name: GVAR.JPG
Dimensions: 756 x 504 pixels

JC-001-026788

Name: AKIBBZ.JPG
Dimensions: 756 x 504 pixels

JC-001-026789

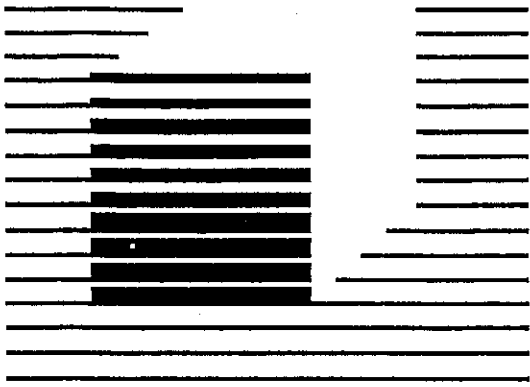

THOMAS E. K

LEBOLD,

LITTLETON, CO 80127

Name: geo2.jpg.PSD
Dimensions: 275 x 150 pixels

JC-001-026790

Name: sh0354.jpg
Dimensions: 800 x 460 pixels

JC-001-026791

Name: manAAA 1.jpg
Dimensions: 2550 x 3300 pixels

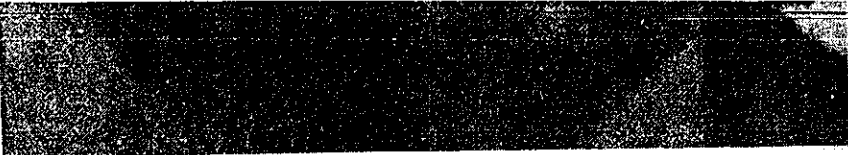

The most widely publicized photograph of Charles Manson. When it appeared on newsstands all over the world, Family members were heard to exclaim proudly, "Charlie made the cover of *Life!*" PHOTO COURTESY OF ROBERT HENDRICKSON AND LAURENCE MERRICK.

JC-001-026792

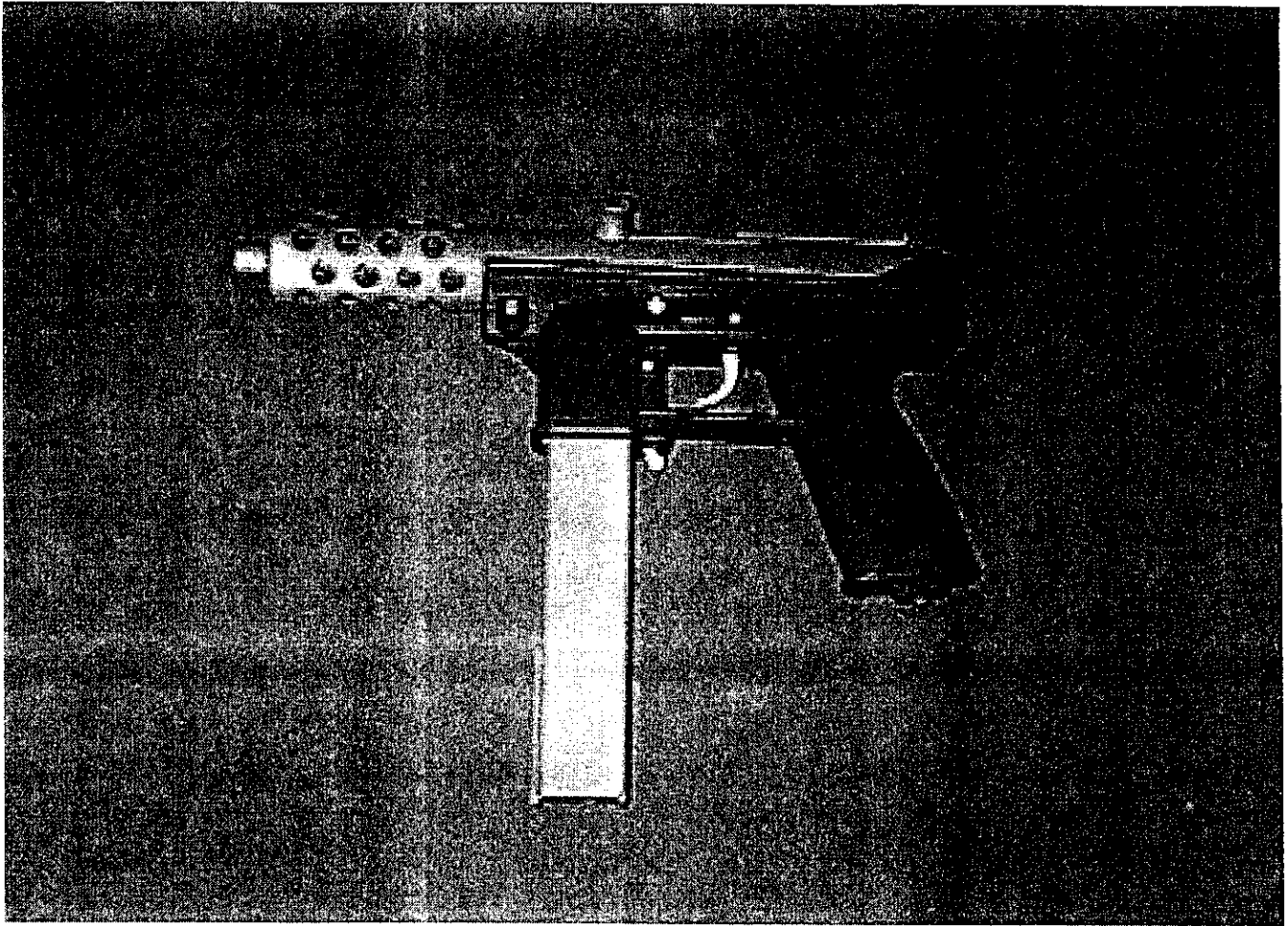

Name: ab-10.jpg
Dimensions: 493 x 373 pixels

JC-001-026793

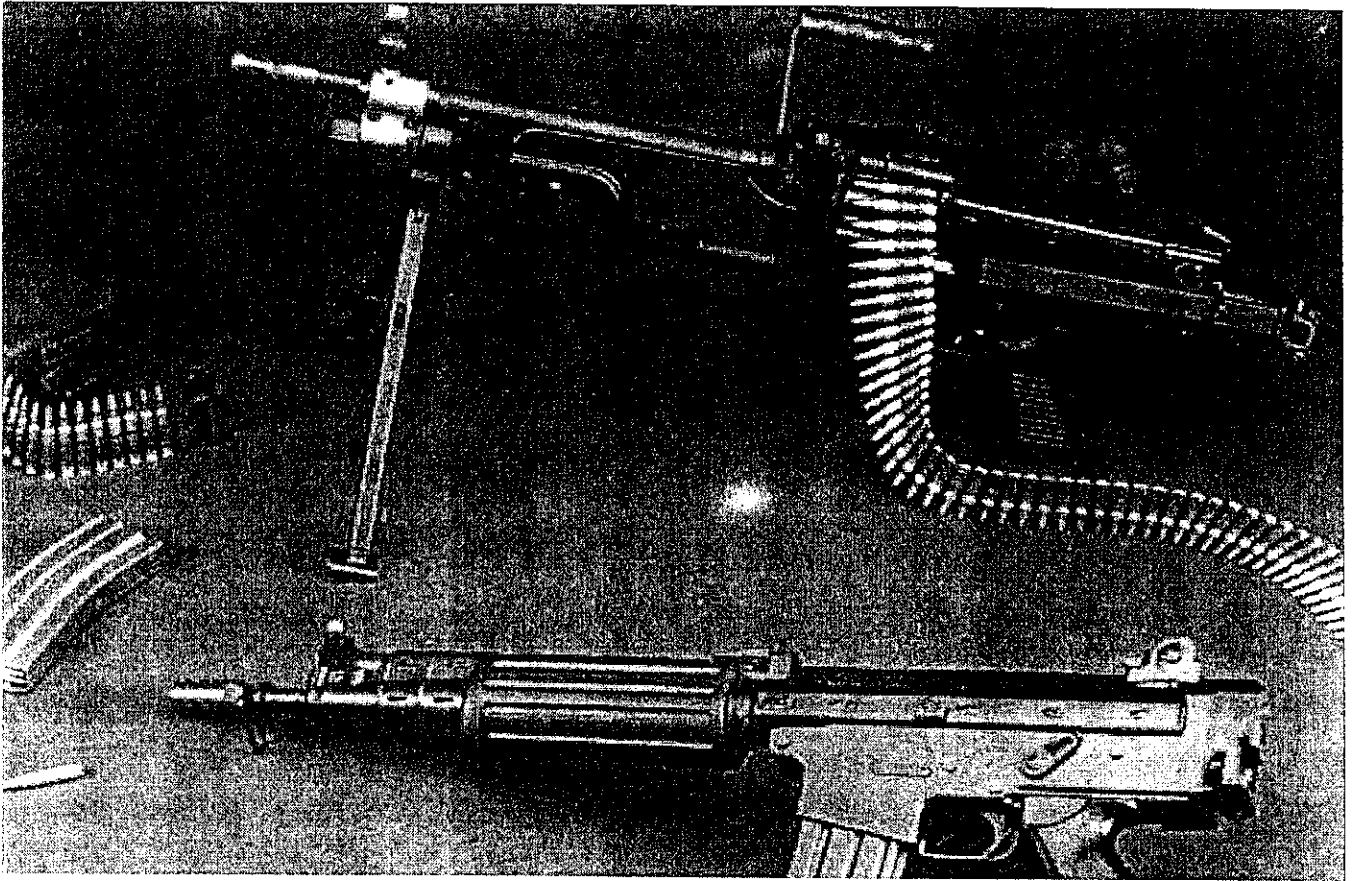

Name: autoguns.jpg
Dimensions: 640 x 480 pixels

JC-001-026794

Name: hksp.jpg
Dimensions: 667 x 496 pixels

JC-001-026795

816 221 9117 ext 11

DENNY'S GUNS

NEW MODEL AUTO & SURGICAL GUN

20 ga. AOW, \$5 TRANSFER TAX

denny@guns.com

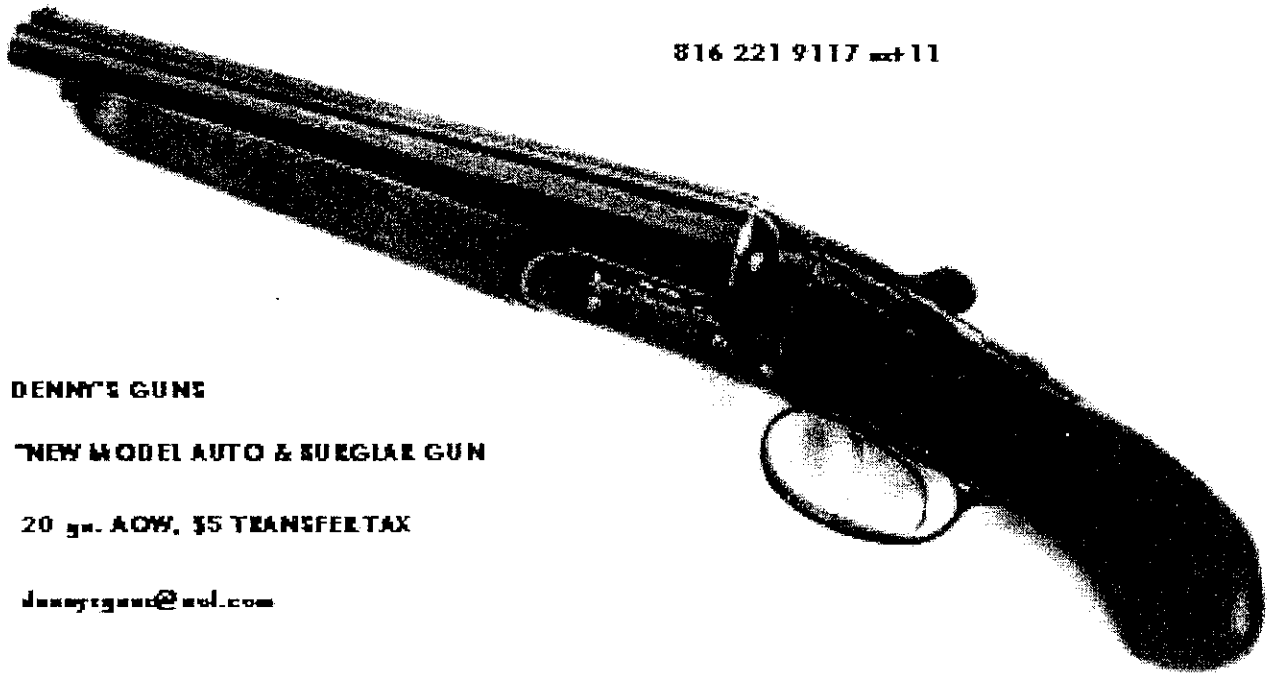

Name: db.jpg
Dimensions: 470 x 248 pixels

JC-001-026796

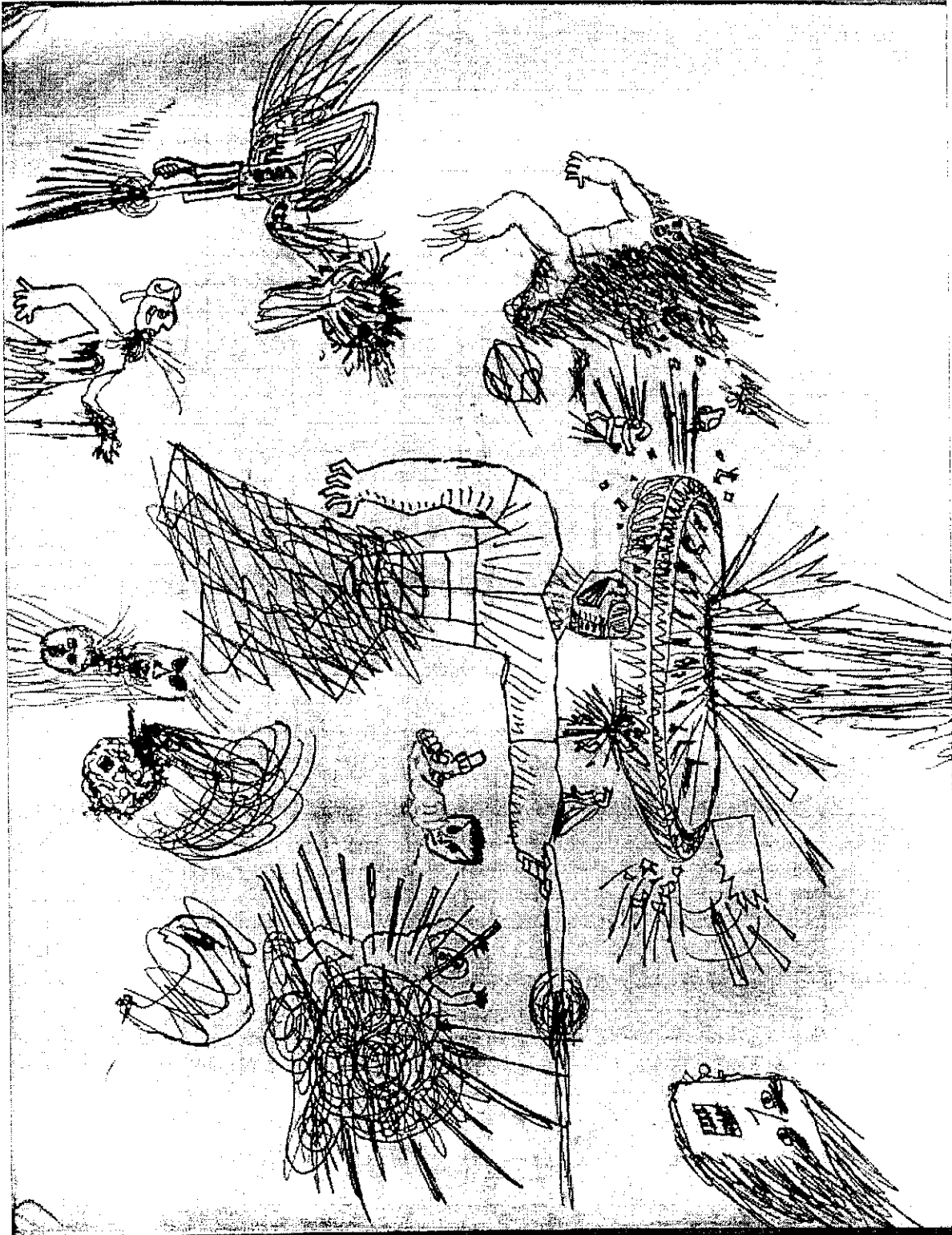

BOOK1.JPG
4/19/99 8:33:54 AM

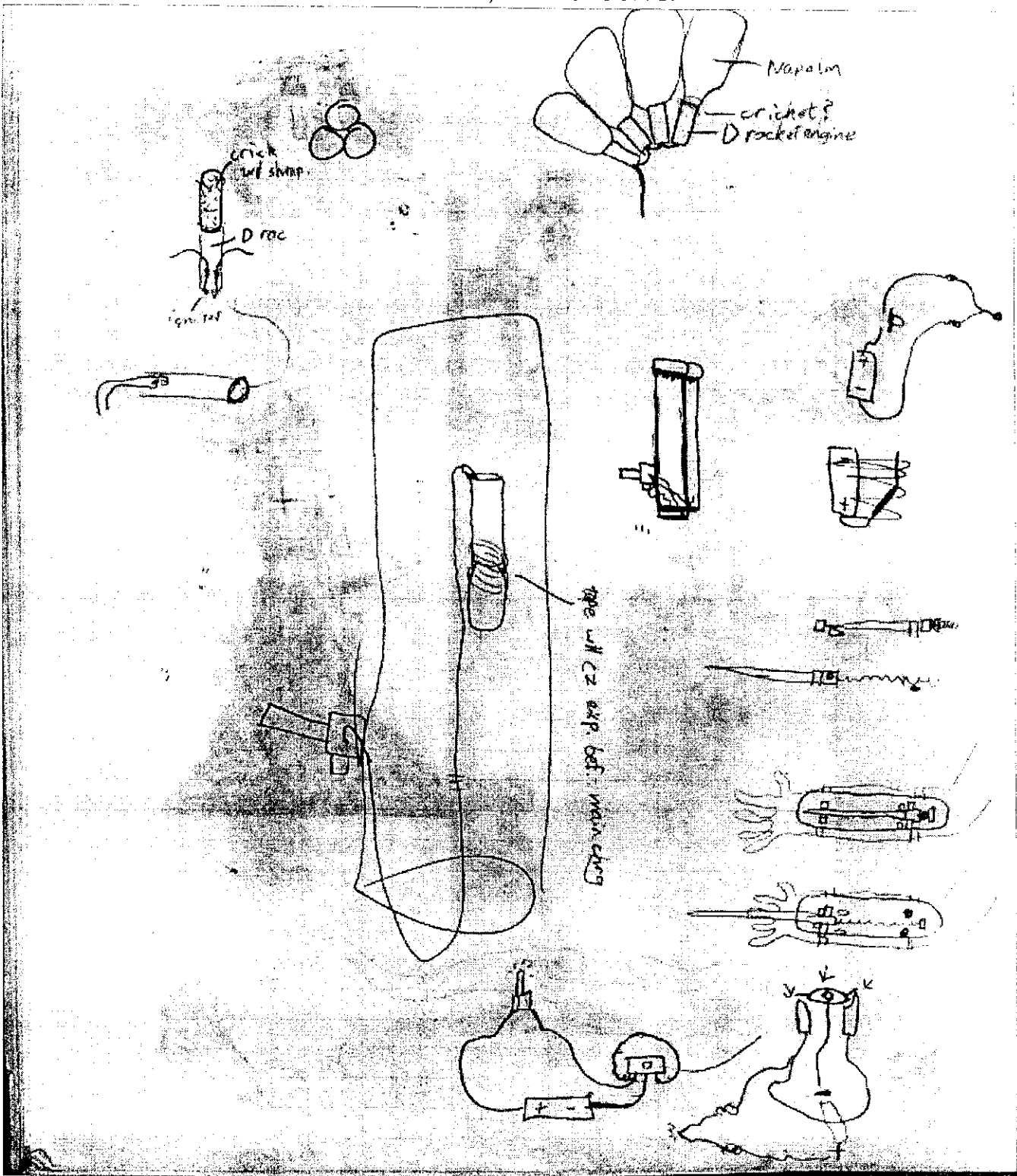

BOOK2.JPG
4/19/99 8:35:12 AM

JC-001-026798

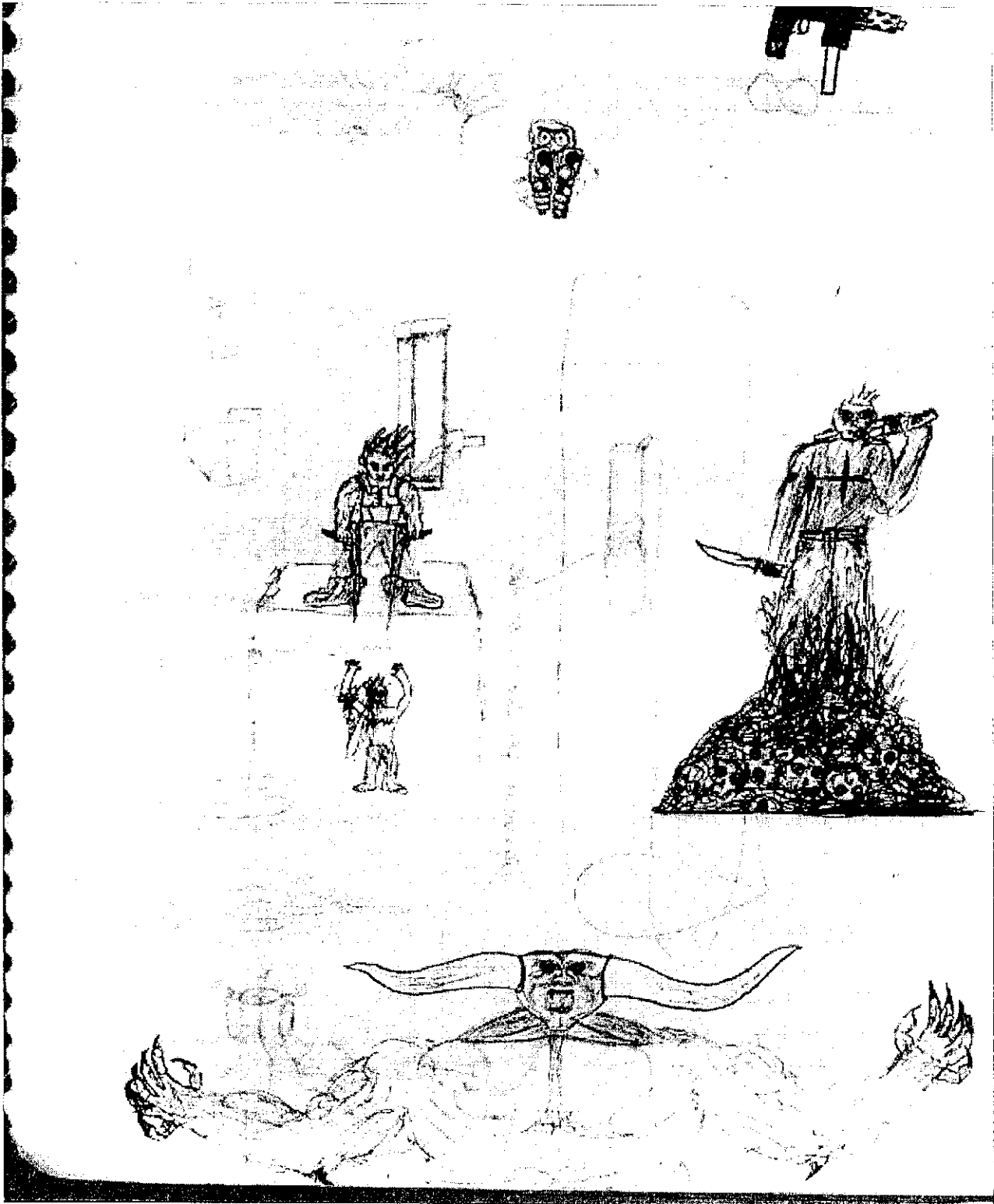

BOOK3.JPG
4/19/99 8:36:36 AM

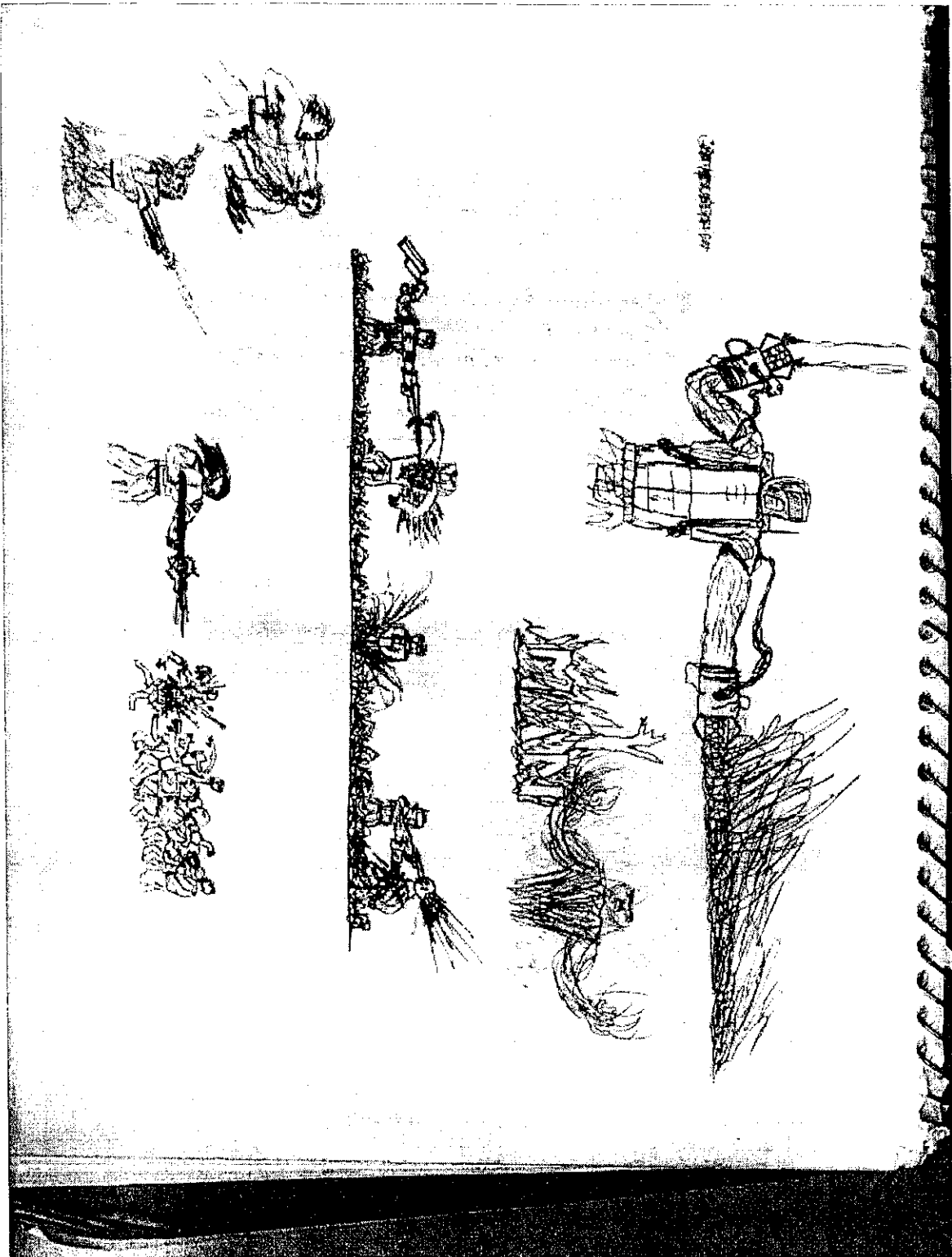







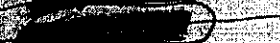

BOOK4.JPG
4/19/99 8:37:56 AM

Canon FVSC

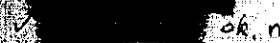

Napalm Tests

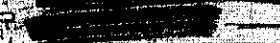
- ✓  — Shitty but in a fix would do ok
-  — good burning, very slick
- ✓  — worthless
- ✓  — needs to be heated, no time
- ✓  — worthless
- ✓  — ok. need more experiments (need to allow it to soak and dissolve)
- ✓  — worthless
- ✓  — detergent — good but need larger test rig + boil heated? no time
- ✓  — Bleach
- ✓  —
- ✓  —



Have
~~\$500~~
 200 - money
 other
 200
 400 - 4 months
 300 - 8 3/4
 200 - 4 1/4
 805?

Noel
~~_____~~
~~_____~~
~~_____~~
 \$20 - Gasoline
 \$200+ - Explosives (Propane tanks, emptying fuel tanks, etc.)

150-R-25

\$50 per tank

shit left to do at 3/30/99

* figure out napalm recipe + danger area

~~_____~~ ~~_____~~ ~~_____~~
 Shotgun - shells - ~~_____~~
 Explosives - ~~_____~~ Time bombs

- time schedule the commons/ people patterns
 - 9mm ammo (150-200)
 - shells (500)
 - practice in-car gear up

560

shrimp
 36 shells + S load
 carbide

- laser for carbide
 - get laid X
 - prepare explosives + distractions
 - comments
 - cars
 - grenades

230 - Propane (u) refill
 25 - 9mm ammo (100)
~~200 - 9mm ammo (200)~~
 15 - Gas (10-13 gal)
 30 - lasers (7)

10 shells + 1 loaded
 30 shells + 100
 600 knife
 long knife

Batch	Size	Powder load	Shrapnel load	# made to date	total made	rating
Crickets				10-10/21/98 11-12/16/98 4-12/17/98 9-2/17/99 used	39	excellent
Alpha				3-10/21/98	3	ok
Beta				1-10/21/98 6-10/23/98	6	good
Charlie				3-10/31/98	3	excellent
Delta				3-1/9/99 5-3/29/99	8	excellent
Echo				2-3/5/99	2	excellent
Fortrot				2-3/29/99	2	excellent
Super Crickets				14-9/12/99		excellent

BOOK7.JPG
4/19/99 8:42:48 AM

JC-001-026803

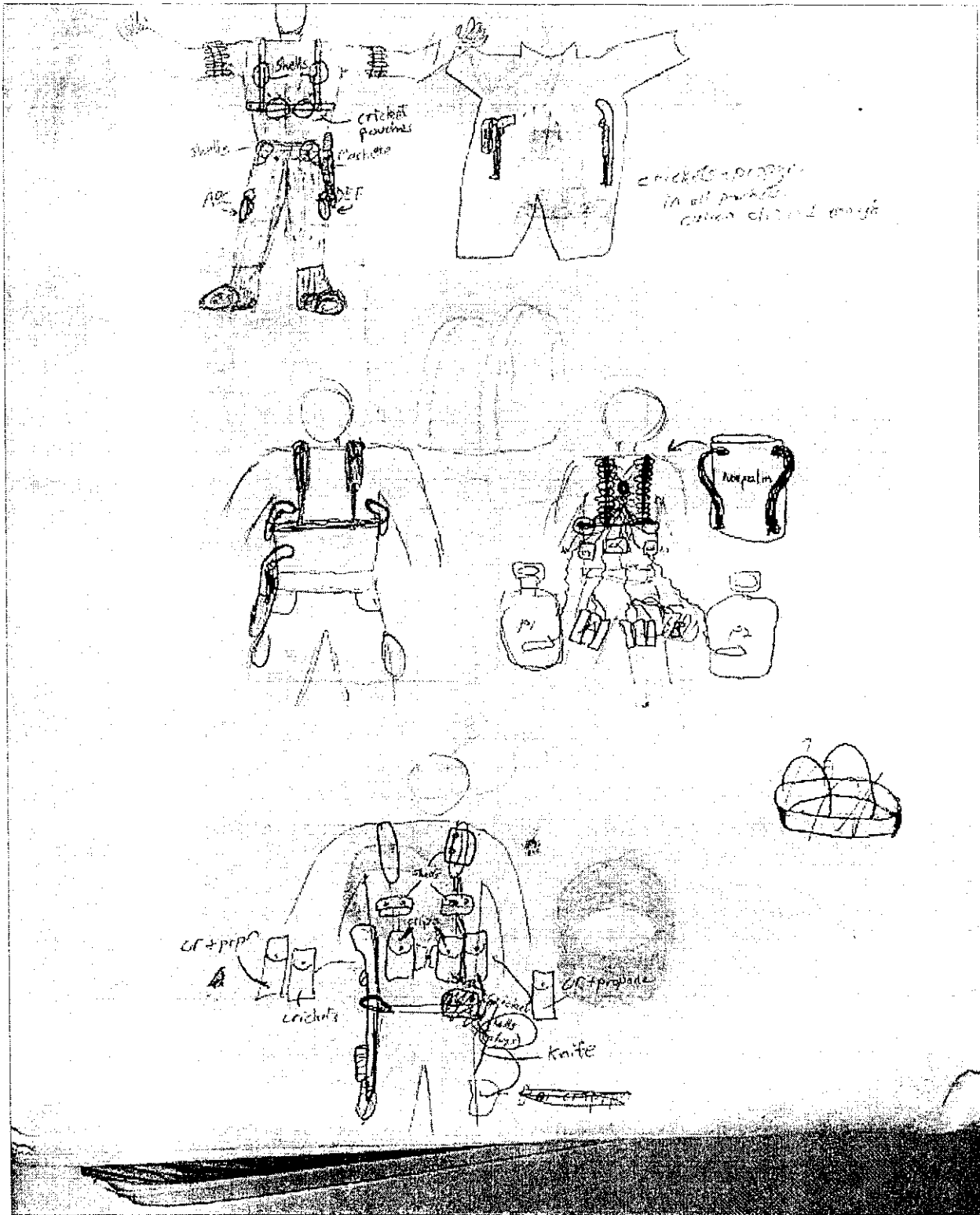

BOOK8.JPG
4/19/99 8:44:06 AM

JC-001-026804

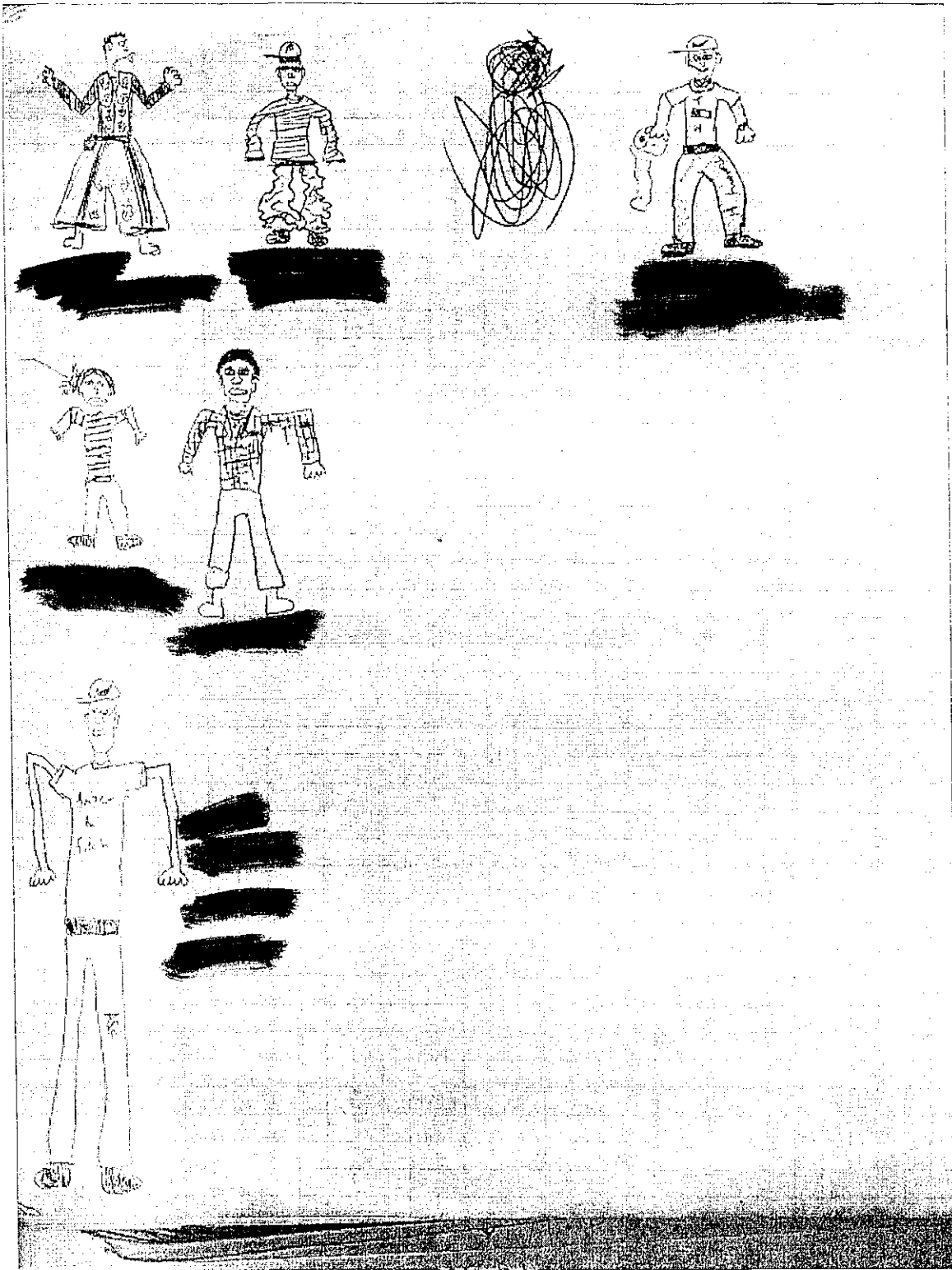

BOOK9.JPG
4/19/99 8:45:30 AM

JC-001-026805



TIERT.JPG
4/19/99 8:09:36 AM

JC-001-026806

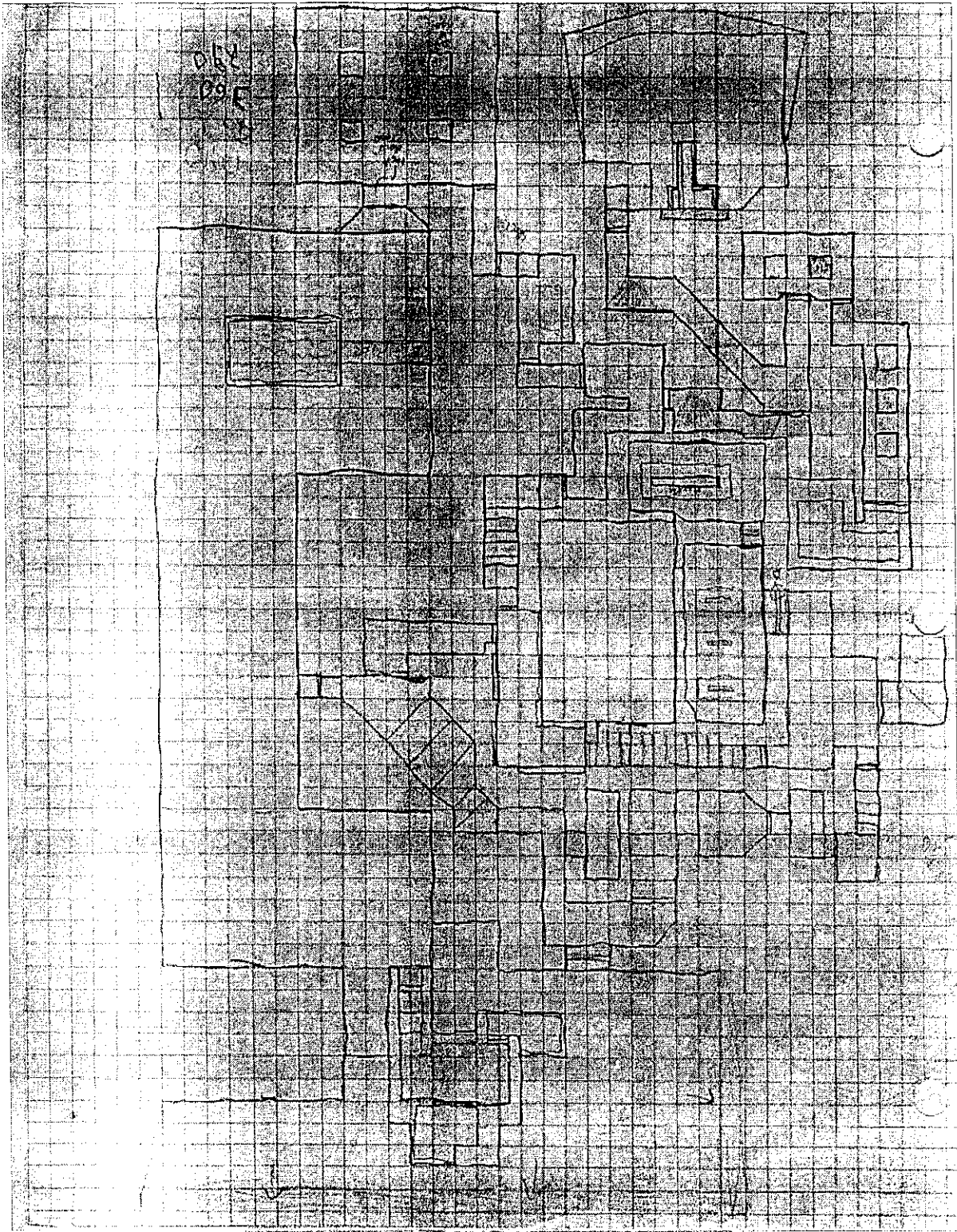

TIER2.JPG
4/19/99 8:12:02 AM

JC-001-026807

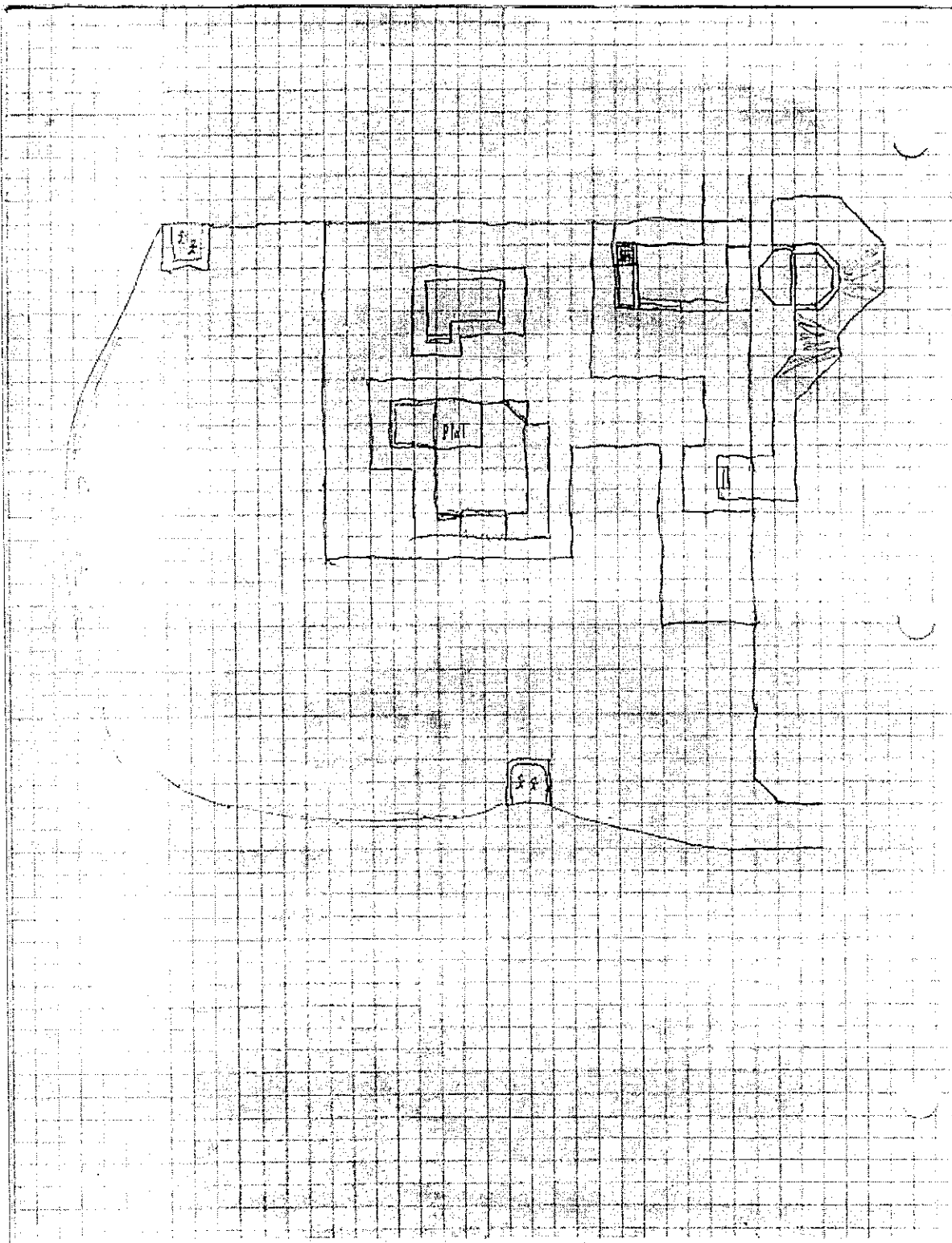

TIER2B.JPG
4/19/99 8:13:36 AM



Demon spawner

code - 787
789

790 - ent 100 - nest
nest code

Sound - one of boss shots (TIER 100)

Death - metallic clang

Frame - 787 (cube) - 789

Death Frame - ~~787~~ 790

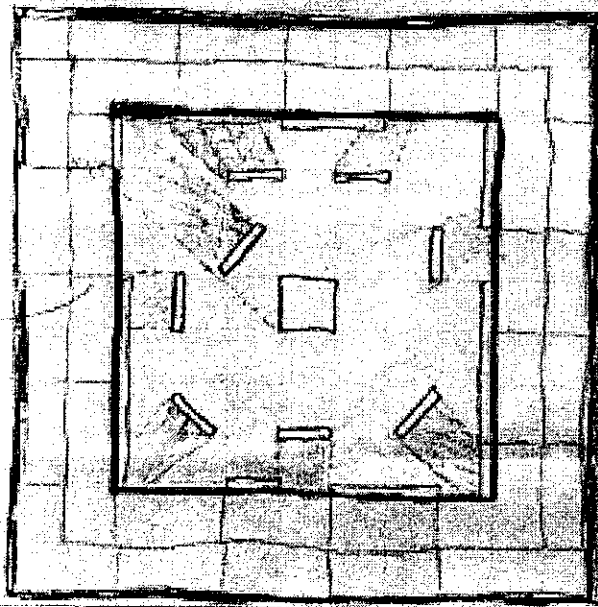
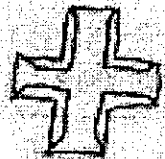
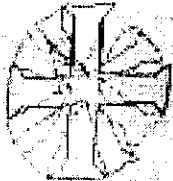

best place
to die is
2.50 here

2
33
8
264

TIER3.JPG
4/19/99 8:15:10 AM

JC-001-026809

Paint It Black

http://camel.ccomcoll.edu/~oother/sf/folder/exile/lyrics/aftermath/paintitblack.html

achtung
 bricks
 champ
 chronix
 doom333
 idmap01
 realdoom
 station
 thrasher
 truchamp
 ualabs
 whiskey
 killer
 Gravity
 Orbit4
 assault
 techout

Fava
 hostepisodes | - Elm
 Hack 2 - D. Edma
 obtic 3 - map16 (D. Dead)
 4 - map9.mid
 5 - map1
 6 - nin8
 7 D. Victor

map9.mid
 Ethercat
 Engel
 Drama
 D. Victor
 map16
 Elmt

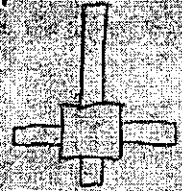
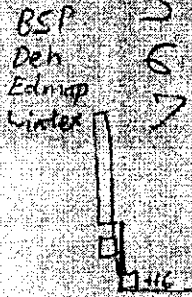

nin-2,8,12

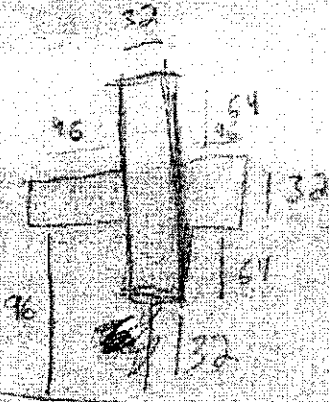
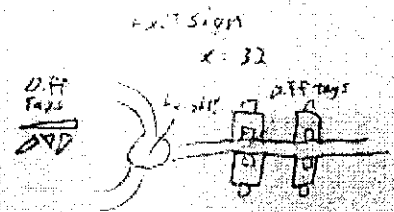

Back to Aftermath: Back to Hot Rocks: Back to Flashpoint: Back to Lyrics

- +1
add teleporter take out sw
- +2
add hallway take out sw
- 3
- +4
add teleporter, take out square exit sw
- +5
add telep. take out sw

1 of 1

9/23/98 9:16 PM

TIER4.JPG
 4/19/99 8:16:34 AM

JC-001-026810

9grat1-2
 8grat4 1
 5 3
 6 1
 2 2
 7 1
 2 2
 3 2
 6
 2 1, 3, 6, 7, 8
 1-3 5-8
 Pip 2, 4
 Wgrat 1

Compl 1
 4
 2
 3
 4
 5
 7
 8
 9

4, 11, 2, 2, 3, 4, 8, 6, 7, 8, 9

1-9
 2-8
 1-9
 2-8
 1-9
 2-8
 1-9
 2-8

1- add a compl, 2, 3
 2- add core 1, 2

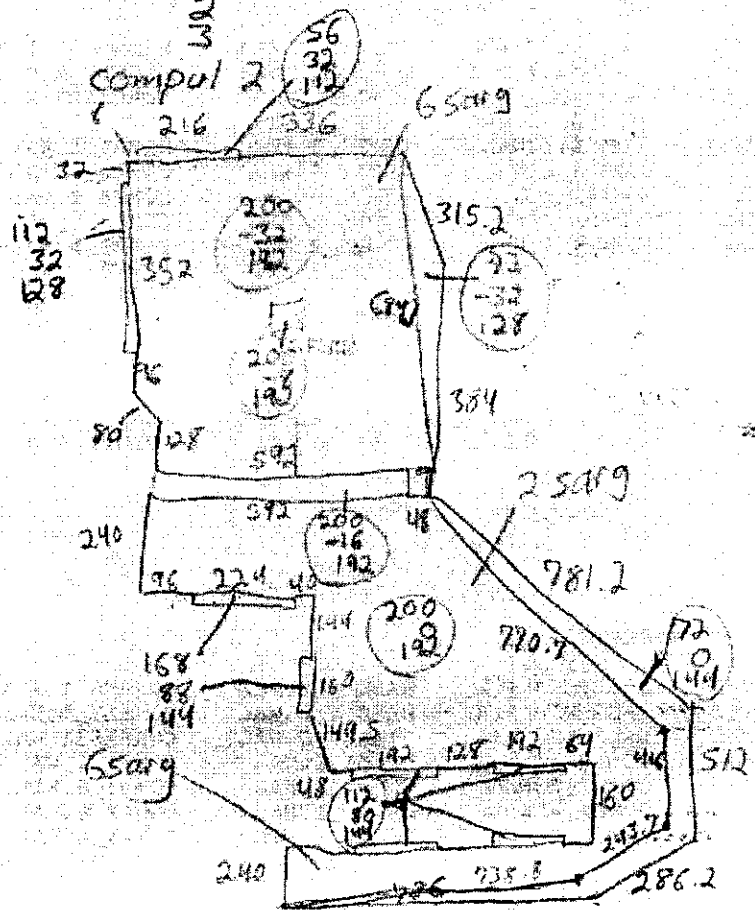

TIER5.JPG
4/19/99 8:17:46 AM

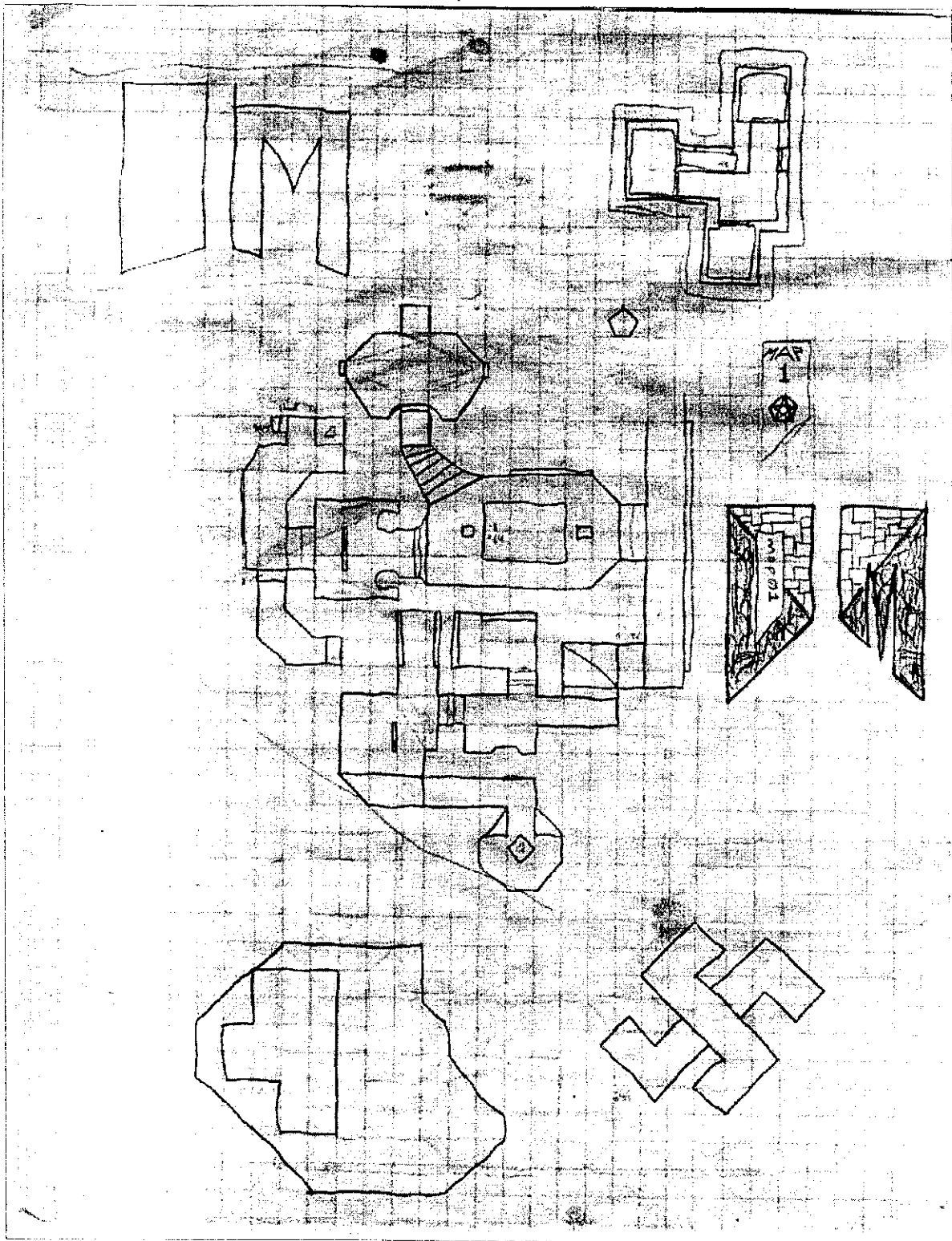

TIER6.JPG
4/19/99 8:19:24 AM

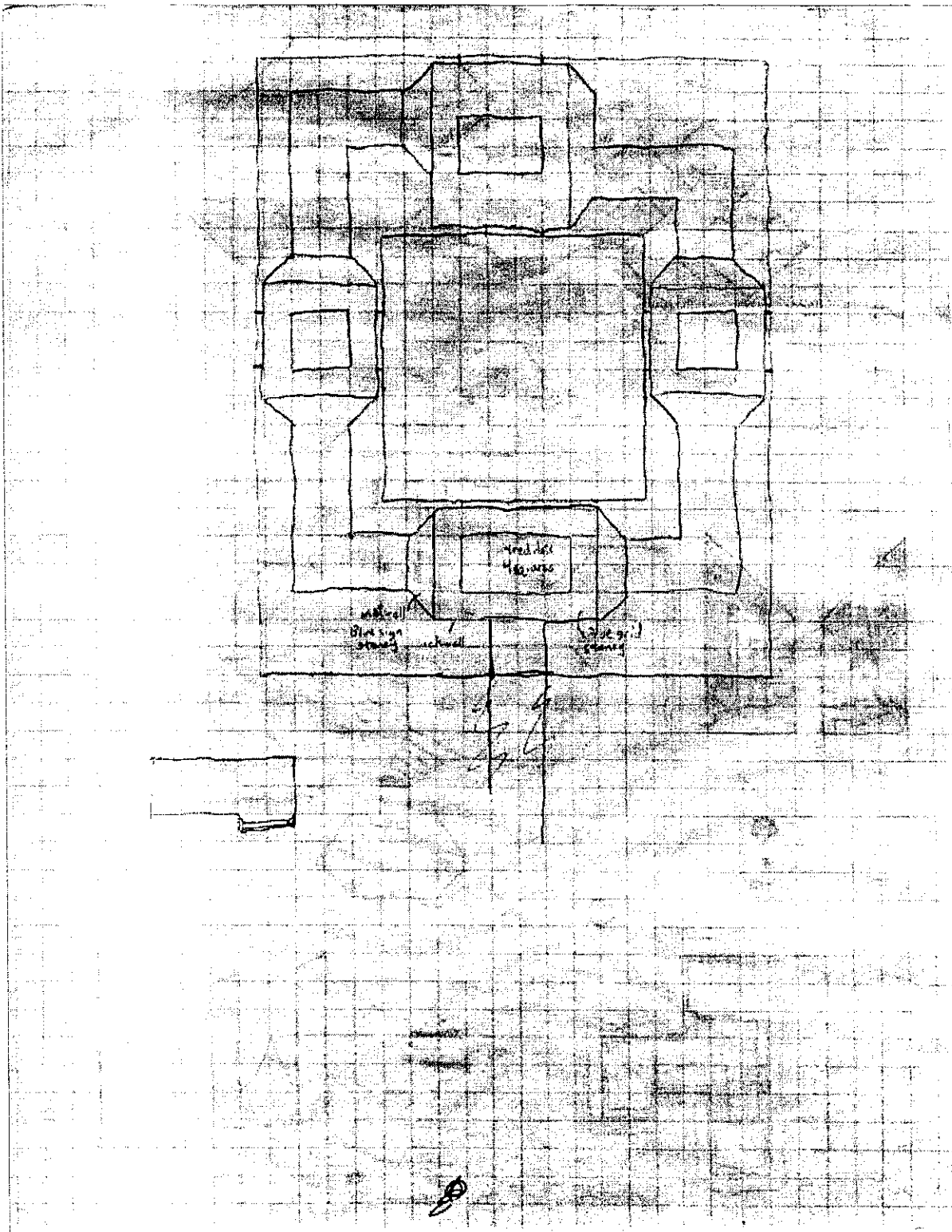

TIER68.JPG
4/19/99 8:20:38 AM

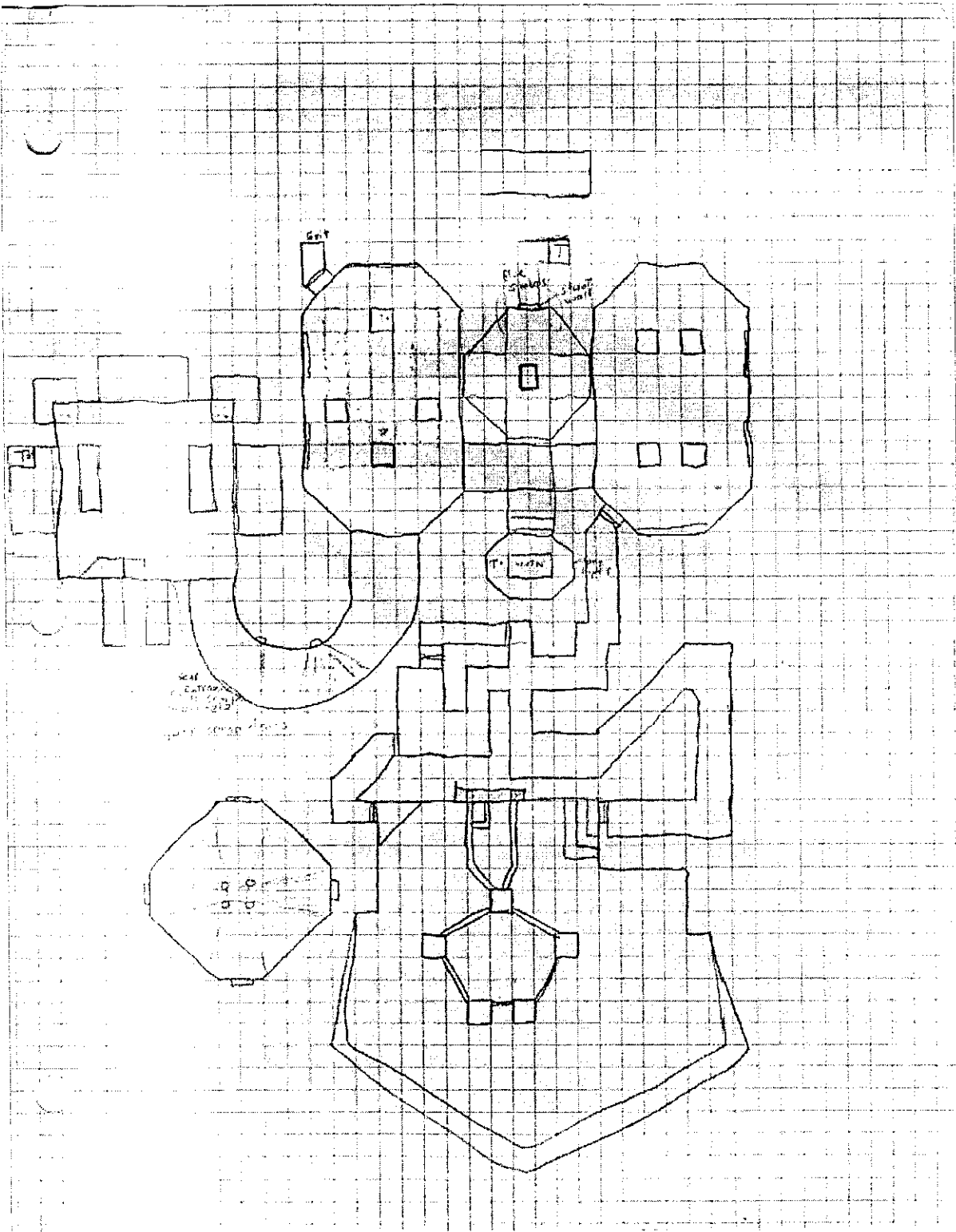

TIER7.JPG
4/19/99 8:22:42 AM

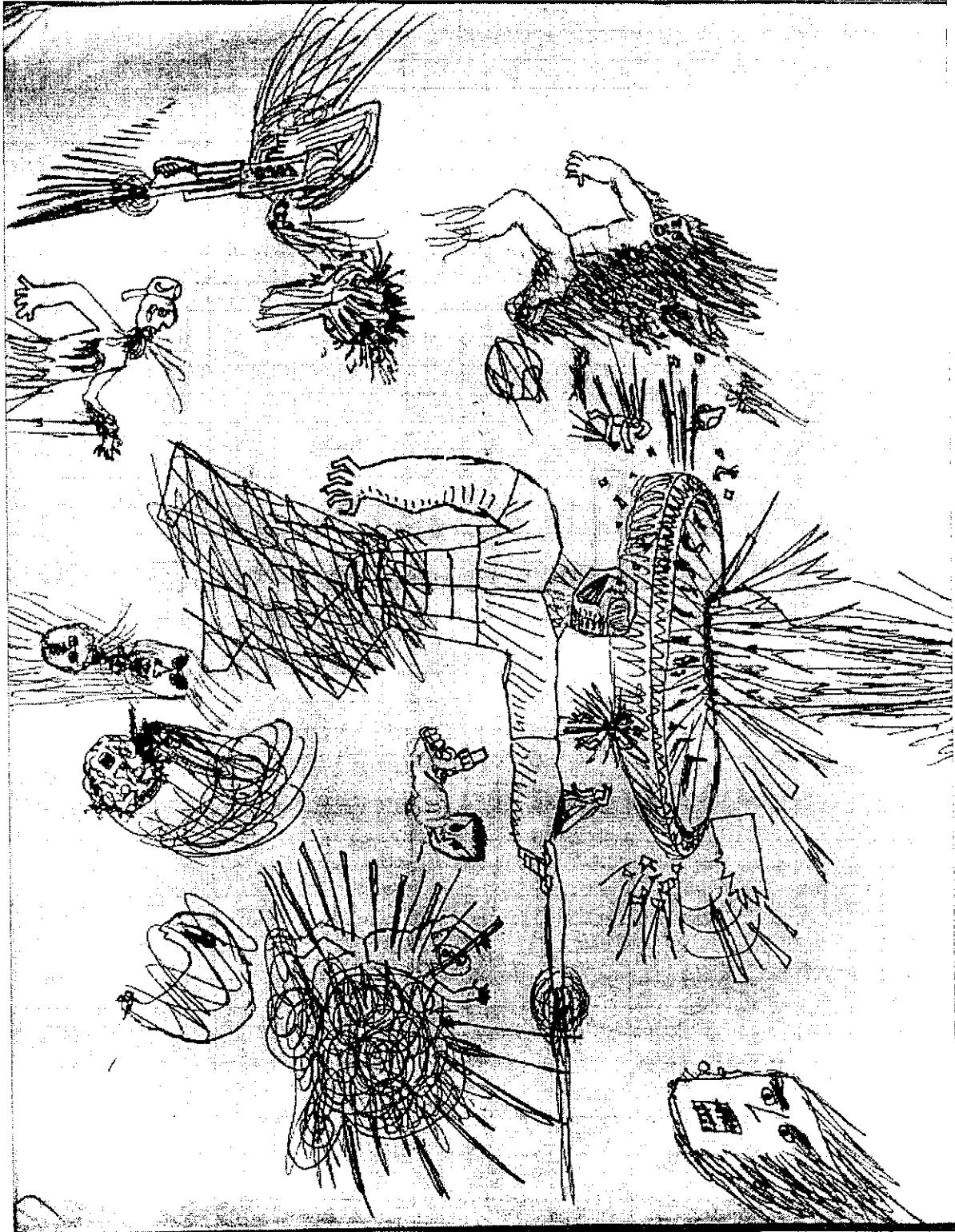

BOOK1.JPG
4/19/99 8:33:54 AM

-nomonsters
-skill 4
-warp 1
-altdeath
-deathmatch
-com2
-dial 3039721105
-player 2

nettype = 0
players = 2
gametype = 0
connection = 2
phonenumber = 3039721105
episode = 0
map = 1
comport = 2
nomonsters = 1
respawning = 0
timer = 0
skill = 4
turbo = 0
usewads = 0
ser_exe = serssetup.exe
ipx_exe = ipxsetup.exe
numwads = 1
TIER.WAD

-nomonsters
-skill 4
-warp 1 -altdeath
-deathmatch
-com2
-dial 3039721105
-player
2
-net 63086

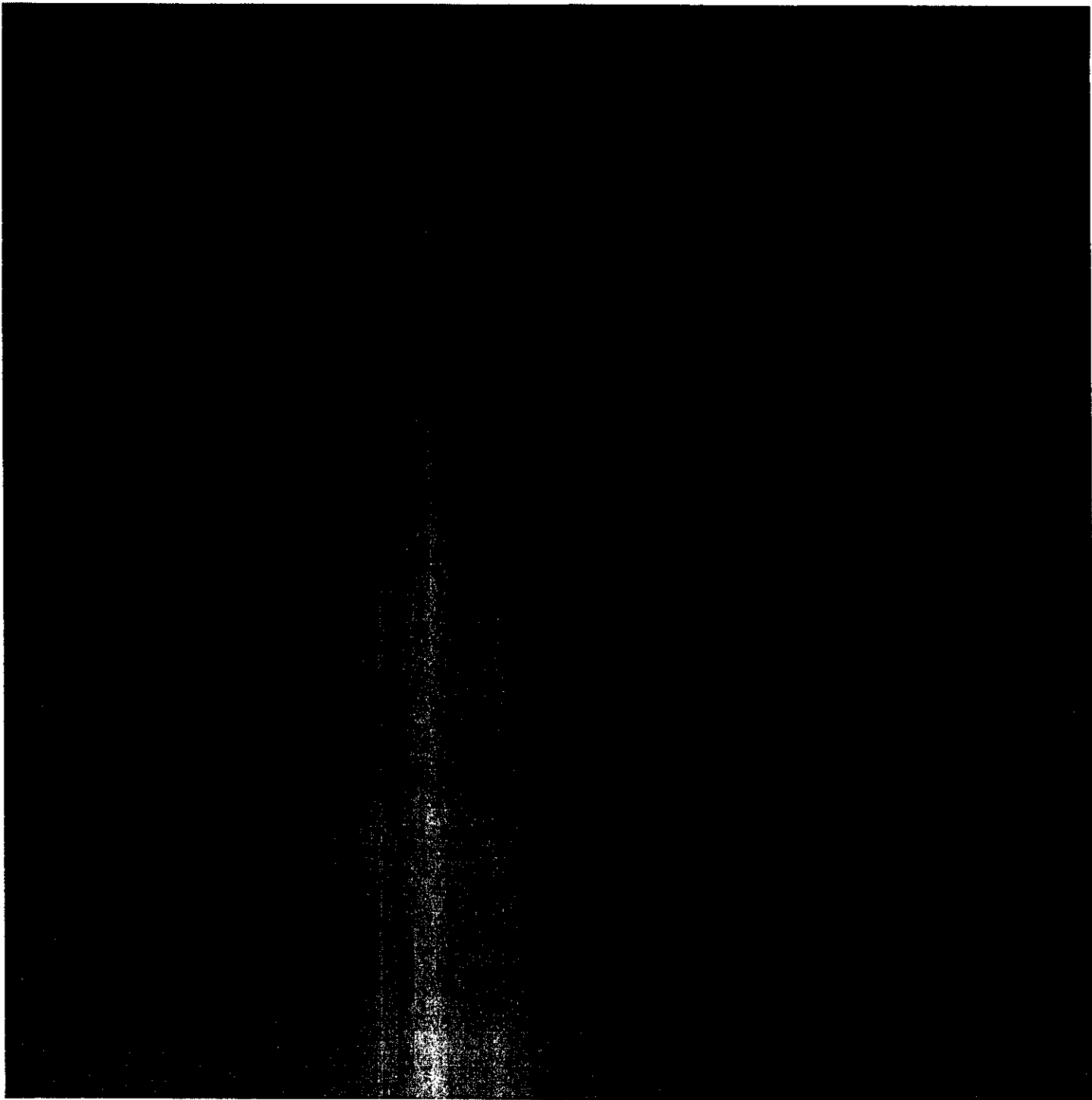

JC-001-026819

@²ÿnÿ+ÿF Guns! Boy, I loved playing ôgunsô as a kid. It is one of the few things I miss from childhood today. Living in a rural town in Michigan for three years, I played a lot in a forest. My brother, two friends and I would always be running around shooting imaginary bad-guys. The woods behind my house were vast, empty, and old. It smelled of a musty tree or maybe of pine trees most of the time in there. Those woods left so many memories in the mind itÆs amazing. Such as how scary they looked during hard rain storms or how dark they were at night. I was even afraid to go into the woods during nighttime, for fear of the unknown. For the most part, however, my memories are fond ones. My brother, Sonia, and I had countless missions in those woods, hunting for enemy troops and stopping invasions. We would set up little tree fort made of loose sticks and branches, and use them for our bases and camps. ôFire!ö I would scream, as we all made as many fast gun sounds as we could, waving our deadly plastic toys around. Almost every time we had a firefight, we would pretend one of us would be injured. We always would carry little bandages and tape with us to dress the wound. Luckily, the bullet would always go right through so we wouldnÆt need to perform surgery. Sonia, being her crazy self, would run right into the battle screaming and firing at all the bad guys, as we gave cover fire. It seemed to vivid, our fighting, and so real. Now that I have actually fired weapons I realize how unrealistic we were, but hey, we were just kids!

ôWhereÆs the air support?!ö my brother screams, as I reload my M16. ôHell if I know!!ö I retort. ôWe got more incoming APCs on our 6Æs, set those mines quick!ö Sonia hollers. The bad guys were surrounding us, but we had plenty of ammo to last us for hours. I toss a few stick grenades into the trees ahead, and duck as they go off killing the wave of enemy troops. Kevin was setting the mines for those trucks and Sonia was launching rockets at the platoon on our left. ôGrenade!ö I scream as I see a stick fall in our base. Sonia and I jump out over the tree trunks as the grenade destroys our base. ôWe gotta move, now!ö Sonia yells in my ear under all the shooting. We run right past my brother and he joins up in the evacuation. Just then our air support flies by overhead. ôThereÆs the gun-ships!ö says my bro., as we dodge tree limbs, bullets, and mortars. We stop at a group of rather large trees and turn and return fire. The air support is dropping napalm on the advancing troops, and launching rockets at the trucks. We pull out a huge machine gun and set it up on a stationary position in a tree. Sonia and Kevin start spraying bullets everywhere as I use hand-to-hand combat on a few bad guys that made it to us. By the time I finish them off with a really strong stick, itÆs time to go inside and do some homework, and Sonia needs to go out to dinner with her family tonight, too. All in a dayÆs work as a kid, I guess.

One of these days, real soon, I will call up Sonia and see if she still remembers me. And see if those woods, our forts, and our hide-outs are all still there where I left them over seven years ago.

Eric Harris
 Period 4
 R.D.

É½¡²²CJ
 ¡É£Ñ½½¡... \$d_
 ¡É£Ñ½½¡
 _/ _=! "#Éá\$Éá%_
 [\$@±_\$NormalmH <A@_|<Default Paragraph Font,@_Header
 !_+!, ,Footer
 !_+!|

á_ê+__+aa_

+ The dream started out in my car. Dylan and me were trying to drive up a very steep hill to get to some event at the top. The road up was barely wide enough for 2 lanes of traffic and there were lots of other people that I recognized mostly from my bowling class trying to get up the hill also. The road was dirty, and the sides of the road sloped upward, so there wasn't much room at all. After lots of honking, yelling, aggressive driving and racing we made it to the top of the hill and parked my car. The next event I remember was struggling to get a bowling ball from an old rack sitting near the wall of a large, open room. If you have ever seen a movie called Demon Knight, it was like the main room in the hotel in that movie. After getting a ball, we ran up an open staircase. All the while people that I don't like in school were taunting us and I had a sense that things were starting to get very tense. At the top of the stairs we no longer had the bowling ball for some reason, and we looked over the railing and fights and brawls were starting downstairs. We ran over to the corner of the ledge and lots of gunfire broke out. We heard several people being shot and a lot of evil growling and yelling. We telepathically seemed to understand that we should stay where we were and wait for a SWAT team to arrive and help us out. A few times we peaked over the ledge and bullets shredded the railing and walls around us. The downstairs was empty, but had several shadows that seemed to have evil, demented inhabitants. After a long time of waiting a team of SWAT guys came in to the ledge from a door beside us and hurried us out of the building. Somehow we were on the ground level as we ran to a few cars and vans parked outside. We looked back and the SWAT team was being shot apart by gunfire. We knew that we had to rescue ourselves since the actual rescue-team was being destroyed. We hopped into a bulky white car and sped off down the hill, just as some sort of rocket flew out of the door of the building and nudged the SWAT van. Somehow I recalled some old sheriff guy in a bronco saying something about how he would escape the mountain roads by cutting across the switchbacks, no matter how steep they were. Next thing I knew we were in this bronco truck and we did a 180 on the dirt road and started to free fall down a few levels of the mountain. We landed on a road and sped off to a quiet little mountain town a few minutes down this road. After this my memory gets a little foggy, but I remember Dylan and I standing behind a large, senile mountain man who was buying a ton of groceries at a lodge. He left a sack of liquor and a pistol on the counter as he left, and I walked up and said something like to bad he forgot these, and paid for my things and left with all of the stuff. After that I can't remember much. And I am sure there were events in between some of those that I forgot as well.

â²CJâ²â_-/_=!"#Éá\$Éá%_

[\$@±_\$NormalmH <A@_i<Default Paragraph Fontâ____ââ

â)úââ__ Wayne N. Harris2C:\windows\TEMP\AutoRecovery save of Document2.asdWayne N.

HarrisC:\data\ERIC\TJdream.doc_@Çéé_téJ

âP@GÉTimes New Roman5ÉÇSymbol3&ÉArial"±ê-h\+2Fo+2F~

_Ñ+||Çr0¿__ Wayne N. HarrisWayne N. Harris__

âf·Oh½æ+'!+0dêÉ£¿+!_

Ç#'+Z+aa_:B As I walked through the broken door entrance to the final military installation, I realized that this hellish experience was almost over. The invasion was stopped, all of the aliens were dead, and whatever wasn't dead was waiting for me ahead. While I was leaning against a granite wall in a large calmly lit room, I scanned over the dozens of marine bodies that scattered the floor in front of me. A last, futile, stand that wasn't enough to ward off the alien attacks. Bullet shells sprinkled the floor, on top of the carpet of blood. I must go on, to fight whatever waited ahead, I am the only one left on humanity's side of the battle. The bright room ahead suggested that I wouldn't have anywhere to hide once I showed myself. I almost laid down beside my fallen comrades and just went to sleep, as some of them appeared to be. But that would mean that they bad guys would win, and I just could not allow that to happen. So I gathered up all the bullets and superior firepower I could scavenge off of the dead soldiers, or what was left of them, and prepared myself for the last battle.

As I entered the last military base on the moon, I came upon a hellish sight. Bodies of my former marine buddies were scattered across the stone floor. The deathly dark glow of light from above provided barely enough light to notice the blood and flesh splattered on the large slabs of granite that passed for walls. The platoon had tried to barricade themselves in, but with the alien fire coming through two gigantic windows and with a blitzkrieg of monsters in the small doorway between the windows, the marines couldn't hold them. Arms, legs, and heads were tossed about as if a small child turned on a blender with no lid in the middle of the room. Some were burnt off, some torn, some eaten. Even though the mass of alien bodies outside the room was at least 10 times the marines', they still fell. I must be crazy to fight this war; I must be out of my battered mind. How could one soldier stop all of these monsters? There must be some way out of here that doesn't involve firepower. It is just too much, all the death and destruction. It's pointless, there's no way, no way at all. I can't fight anymore-let them take Earth-I'll stay here on my little moon-along with my squad of dead soldiers.

²CJPQ

²²²PQ

-/=__=!_"_#Éá\$Éá%_

[\$@±_\$NormalmH <A@_i<Default Paragraph Font _____

μ_ KL_±|+á _____Wayne N. Harris2C:\windows\TEMP\AutoRecovery save of Document1.asdWayne N. HarrisC:\data\ERIC\mood1.docWayne N. HarrisC:\data\ERIC\mood1.doc_@Ç_p@-__ P@GÉTimes New Roman5ÉÇSymbol3&ÉArial"±ê-h_Æ1&Là2FOy_Ñ+||Ç20- _____Wayne N. HarrisWayne N. Harris__
àf•Oh½æ+!'+0dêÉ£¿+|_ °

@ä"fH+1.Ü This female, who I will call Betsy, is a sad woman. She spends all of her time in front of a mirror putting make-up on. She seems like a slutty, trendy bitch that people like to look at since she seems ôprettyó by the social standards. She feels very dense, she just smiles and says ôgosh, OK!ô in a cheerful but dumb manner. She just wants to be liked. She doesn't know she is different, she thinks she is normal and not different. Some words that would describe her are dense, stupid, shallow, and dazed. She feels happy yet uncomfortable. She is covered with pasty-tan make-up and has golden hair. She smells of cheap perfume and hairspray. I hear windàor the oceanâwhen looking at her. She remembers that she has an audition coming up for a cheap B-movie part where she thinks she will be acting. She feels smooth yet cold. The taste of polyester comes to mind.

Eric Harris
 Period 4
 Picture description.

r¿_²²CJrstÇèP fáíóúñÑªº¿_°+__+±±±+°+±±±·\$d_rstÇèP fáíóúñÑªº¿_____°_____

_-/ __=!_"#Éá\$Éá%_
 [\$@±_\$NormalmH <A@__í<Default Paragraph Font,@_,Header

!_+!, @,Footer

!_+!____-/1358__îÆræ£º~rèPº~__Wayne N. Harris2C:\windows\TEMP\AutoRecovery save of Document1.asdWayne
 N. HarrisC:\data\ERIC\picdescr.doc_@ÇXt_P@GÉTimes New
 Roman5ÉÇSymbol3&ÉArial"qê-h•-1+1+__Ñ+!|Ç20|__6C:\Program Files\Microsoft Office\Templates\Normal.dotWayne N.
 HarrisWayne N. Harris__
 àf•Oh½æ+!+0dêÉ£¿+!_ °

Ç"ê+ #+aa:x
Trenchcoat Mafia
Hit-Men
For Hire

Eric Harris
Period 2
12/10/98
T-dog

Table-of-Contents

- 1: Product Overview
- 2: Map
- 3: Business Organization
- 4: Fund Raising
- 5: Advertising Campaign
- 6: Conclusion

Product Overview

In this city, protection is needed. Day by day people grow more and more agitated with one another and become less understanding and forgiving. Even though programs made by anti-hate groups and police try to keep people from being prejudiced and having stereotypes, most people are still the same. The so-called "Trench Coat Mafia" is a small group of friends who generally wear dark clothes, military fatigues, and long black dusters. Most people usually just stare and whisper when they see us. We don't mind because we generally don't like people anyway. Now they have reasons to stay clear of us.

MAP

This map depicts our current locations. We are located in a few different houses in the Columbine area, along with a safe location in the mountains. We also have connections with people in Mexico, Germany, South Africa, and New York City. The locations in the Columbine area are strategically positioned so we can launch attacks in almost any neighborhood with a few minutes notice. We also have caches of weaponry and explosives located around the CHS area and in certain fields, all to serve you, the customer.

Business Organization

Now, with more and more violent fights and nearby gang activity at locations like Chatfield, we believed that we needed to start a business. The business is basically to kill people who anger our clients. Hence, the "Trench Coat Mafia Hit-Men for Hire" business was created. Several weapons, such as a sawed-off pump-action riot-gun, an AB-10 machine pistol, home made rocket launchers, swords, and daggers were gathered to help our business. Now on school grounds we can't be armed. Everyone knows that if someone is caught with a weapon they are suspended or expelled, which would not help my business at all. Therefore, using our resourceful home computers, we acquire the full name, telephone number, and address of our target. Then we hunt the target down and relocate him/her to one of several secluded areas, like the bottom of a lake.

Fund Raising

As far as costs are concerned, we can be pretty lenient. For underclassmen, the cost is \$50 a day for general protection. For upperclassmen it is \$20 a day. Now if you wanted someone so intimidated that they would not even get out of bed in the morning, that costs about \$100. Assaults and beatings can range from \$200 to \$500, depending on the severity. For relocation of problem targets, the price is usually between \$1,000 and \$10,000. It basically depends on the location and time of the hit, as well as if there will be witnesses or if it requires us to take out a whole group of targets.

We raised enough money to start our business strongly. Most of the money came from personal reserves. We also got money from relocated targets. Weaponry we already had, and ammunition isn't too expensive these days. Political contributions are the main expense.

Advertising Campaign

Our advertising campaign is quite simple. We don't want to start a war, at least not yet, so we can only help certain groups of people. We will help whoever is willing to pay the most for our protection. It is a first-come-first-served basis. My business will reach the intended audience by word of mouth alone. That may seem like we wouldn't get many clients, but we have already made \$20,000 since we started the business only a few weeks ago.

So if you need our help, just come up to me, or one of my associates, and tell us a little about yourself and your problem. We'll see what we can arrange for you.

Conclusion

The fact is that people need protection from the dangers of every-day encounters and the δTrench Coat Mafiaδ is willing to protect you. For a small cost, you can walk the halls knowing that you have your very own personal guards keeping a close eye on you. No one, no matter what size, will give you any trouble.

"#J^`--+_!"34_¶HLP Q g A

B

d

e

BC+

@+.<(+-+ My last article is on the new Brady bill. The Brady bill that went into affect recently requires all licensed gun deals to have instant background checks from the FBI when selling a firearm of any kind. In theory this was a good idea. This would keep guns out of the hands of people who have felony charges on their police record, dishonorable discharge from the military and illegal immigrants. The background checks will take anywhere from thirty minutes to a few days.

The FBI just shot themselves in the foot. There are a few loopholes in the new Brady bill. The biggest gaping hole is that the background checks are only required for licensed dealers not private dealers. The number of licensed dealers dropped from 5,011 in 1993 to 1,715 in 1998. Private dealers can sell shotguns and rifles to anyone who is 18 or older, and they can sell handguns to anyone who is 21 or older, without background checks of any kind. Another problem with the bill is that misdemeanor crimes of abuse and violence do not show up, and sometimes police and mental health records aren't put into the FBI's database. Only about 50% of the needed information is there. Therefore 50% of the criminals who want guns have a pretty good chance of getting them from a licensed dealer.

!_2CJ!_2!_2_/_=__=!"#Éá\$Éá%_

[\$@±_\$NormalmH <A@_í<Default Paragraph Font*B`_* Body TextCJ_____âà__Wayne N.

Harris2C:\windows\TEMP\AutoRecovery save of Document1.asdWayne N.

HarrisC:\data\ERIC\article7.doc_@Ç__pu_+_`@GÉTimes New

Roman5ÉÇSymbol3&ÉArial" _ê-h¥,â_â+|Ñ+||Ç20__6C:\Program Files\Microsoft Office\Templates\Normal.dotWayne N.

HarrisWayne N. Harris__

àf•Oh½æ+"!+0dêÉ£_+_!_ °

á_!i+aa_! The anger management class I took was helpful in many ways. I feel the instructors were well qualified for this class and the class size was not too big. I learned several things about how drugs and alcohol contribute to violence, and how to avoid using drugs and alcohol. I felt like the class was focused more on people who had committed violent crimes and people who use drugs and alcohol, rather than being more broad. Nevertheless I still learned what anger is, how to recognize it, and how to deal with it. Violence is expensive, along with anger. Committing violent crimes brings forth fees, bills, and punishment that have very deep affects on that person, not to mention the emotional turmoil it causes. I learned the four stages of anger; tension building, verbal escalation, physical escalation, and opportunity for change. I believe the most valuable part of this class was thinking up ideas for ways to control anger and for ways to release stress in a non-violent manner. Things such as writing, taking a walk, talking, lifting weights, listening to different music, and exercising are all good ways to vent anger. We also discussed the positive and negative results of anger and violence. Another thing we discussed was ôtriggers.ô Triggers are defined as warnings or symptoms that one experiences when getting angry. Things like quick breathing, tunnel vision, muscles tighten, and teeth clench. I feel that all of the suggestions can all be helpful, bu

t the main part of anger management comes from the individual. If the person does not want to control his/her anger, then it can be a problem. The person must want to control his/her anger and actually want to not be violent or angry. It all starts in the personÆs mind. I have learned that thousands of suggestions are worthless if you still believe in violence. I am happy to say that with the help in this class, and several other diversion-related experiences, I do want to try to control my anger.

+²CJ+²+ _/ __=!_"#Éá\$Éá%_

[\$@±_\$NormalmH <A@_j<Default Paragraph Font+___+++ -!-=_Wayne N.

Harris2C:\windows\TEMP\AutoRecovery save of Document2.asdWayne N.

HarrisC:\data\ERIC\angermanagment.docWayne N. Harris7C:\windows\TEMP\AutoRecovery save of angermanagment.asdWayne N. HarrisC:\data\ERIC\angermanagment.doc_@Ç!+ùu!++@@GÉTimes New Roman5ÉÇSymbol3&ÉArial"±ê-h@¶+!_+?H)=_Ñ+!!Ç0d/_6C:\Program Files\Microsoft Office\Templates\Normal.dotWayne N. HarrisWayne N. Harris__

àf·Oh½æ+!'+0dêÉ£¿+!_ °

@eñ_D+Ç:öEveryday events can change a life significantly and we might not even be aware of it. Everything we do, say, and see and everything others do always will affect us, no matter what we think. Therefore, it is hard to say which event in my life has had the most serious, dramatic change. I do believe what happened on the last Friday night in January 1998 is the most significant event that has changed my life. My friend Dylan and I were driving around that night at about 9:00 PM with nothing to do. We decided to go to the a dirt parking lot off of deer creek canyon road to just kind of ôhang outö to kill sometime. We were planning to check out some movies, and go home to my house and just spend the night there, just another weekend night. We arrived there, and there were 2 cars, a large white utility van and a small red truck, already parked there. We were the only ones there so we just walked around, broke some bottles we found there, lit off some fireworks, and just talked. Then we began thinking about breaking into this van. No one was around, we had a clear line of sight to anything coming and going, and the van was stuffed with electronic equipment. We thought there was no way we would get caught, and everything seemed so easy. So we got a rather large rock, broke the window and Dylan started removing items from the van while I waited in my car keeping a look out for incoming cars. After about 10 minutes I said ôthatÆs enough, letÆs go.ö So we left the scene and went up to an open space in the mountains. We were sure we had gotten away with it all, so we started reviewing what we had stolen. I got out of my car to put something in my trunk when a Jefferson County sheriff shined his rather bright flashlight into my eyes from the other side of my car. Right then I realized what a damn fool I was for what I did. He had been watching us for about 5 minutes, apparently he had seen us far away, parked his car down the road, and walked up behind my car without us noticing him. We told him everything, and we were arrested. We spent that entire night waiting for the cops to finish searching my car, waiting at the station and filling out forms and giving statements to the cops, explaining to my parents what we had done and why, and then going up to Golden to get ôbooked.ö After a very unique experience in a real live police station being a real live criminal, I had lots of time to think about what I did. Remorse put it lightly. I spent about 4 hours there, only about 15 minutes of that was I actually doing something, like giving them any and every imaginable way of taking my fingerprints, or taking my picture. Actually, mug shot would be a more appropriate word. I waited for the rest of the time. Their computer chose that moment to break down, so they put me into prison-type bathroom to wait. As I waited, I cried, I hurt, and I felt like hell. We got home at about 4:30 AM that morning. My parents lost all trust in me, and were completely disappointed beyond belief. April is when our court date finally came around, and we were both sentenced to 1 full year of diversion. Which is a lesser charge since we plead guilty to all charges. So, the consequences of that night were; 1 year diversion which includes about 350 dollars worth of fines, a total of 4 full days of classes such as anger management and mother against drunk driving, 45 hours of community service, 2 months grounding, 120 dollar fine for getting my car back (it was impounded), and I am seein g a psychologist to help me with my anger problems. I am glad neither of us drink or do drugs, because that would have sky rocketed our already orbit-level consequences. My parents lost all respect and trust in me and I am still slowly regaining it. That experience showed me that no matter what crime you think of committing, you will get caught, that you must, absolutely must, think things through before you act, and that just because you can do something doesnÆt mean you should. To this day I still do not have a hard realistic reason why we broke into that car, but since we did, we have been set on a track that makes it mandatory for me to be a literal angel until March of Æ99. So that will hopefully keep me out of any trouble that I would have gotten into my senior year. Personally, I think that whole entire night was enough punishment for me. On the good side, I have had many new experiences that I am sure will help me with life as a result of being on diversion. So all in all, I guess it was a worth while punishment after all.

Eric Harris
 Period 2, T-dog.
 11/19/98

±#S²²CJ± ___ !"#°+ _±±± _____ + _____ °\$ä-dh± ___ !"#S _____ ° _____

_/ __ =! " #Éá\$Éá% _
 [\$@± _\$NormalmH <A@_ i<Default Paragraph Font.@_ .Header

JC-001-026833

_____ \$ ____ Nazism was a form of government unlike any other in history. Lead by Adoif Hitler, the Nazis had distinct beliefs and policies, severe racism and hatred, strong, new family values, and plans for future Germany and the world. The Nazi party came to power in the early 1930s, thanks to Adolf Hitler. Hitler was loved and admired by all of his followers. The Nazis derived many symbols from ancient runes and made code names for things like their concentration camps. They also formed several new laws and restrictions. Racist beliefs and violent actions were all part of everyday life in Nazi Germany. Concentration camps killed millions of people using gas chambers and firing squads. The Jewish race was considered inferior, and therefore extremely and harshly discriminated against by law. Family values were encouraged, education was reformed, the women's roles were outlined, the Aryan race was to be the only race, and law controlled breeding. Education was reformed in order to benefit the state, not the individual. The woman's main role was to bear children, cook, and clean. The Aryan race was the only "superior" race, so therefore Hitler wanted Germany to have all Aryan citizens. Only the elite would reproduce and inferior races were restricted from breeding with the superior race. Hitler had several plans for his new Germany, and for the world as well. Hitler wanted leaders in Germany. He also wanted to control what everyone saw and heard to maintain a working state. The youth of the world was to be under Nazi control, and Europe and Russia were to be conquered. Approximately eleven million people died as a result of the Nazis. The Nazis were one of the most racist forms of government ever.

The Nazi Culture

Thesis: Nazism was a form of government unlike any other in history, with their beliefs and policies, their racism and hatred, their very strong family values, and the plans they had in store for the rest of the world.

The Nazis

How they came to power

Hitler

Love for Hitler

Energy

Who they were

Runes

2. Code words

Policies

Censorship

Control

Euthanasia

Aliens

Racism and violence

Concentration camps

Doctors and wives

Shootings

Gas chambers

Reinforcement of hatred

Jews

Insults and racist comments

Inferior race

Family values

Education

What education would benefit

Textbooks

Science in racism

Women

Children

Discrimination

Aryan race

Mental

Physical

Breeding

Only the elite would reproduce

Jews as inferiors

Future Plans

Europe

Leaders

Freedoms

Censorship of the nation

World

Youth

Russia

Space

PAGE i

JC-001-026835

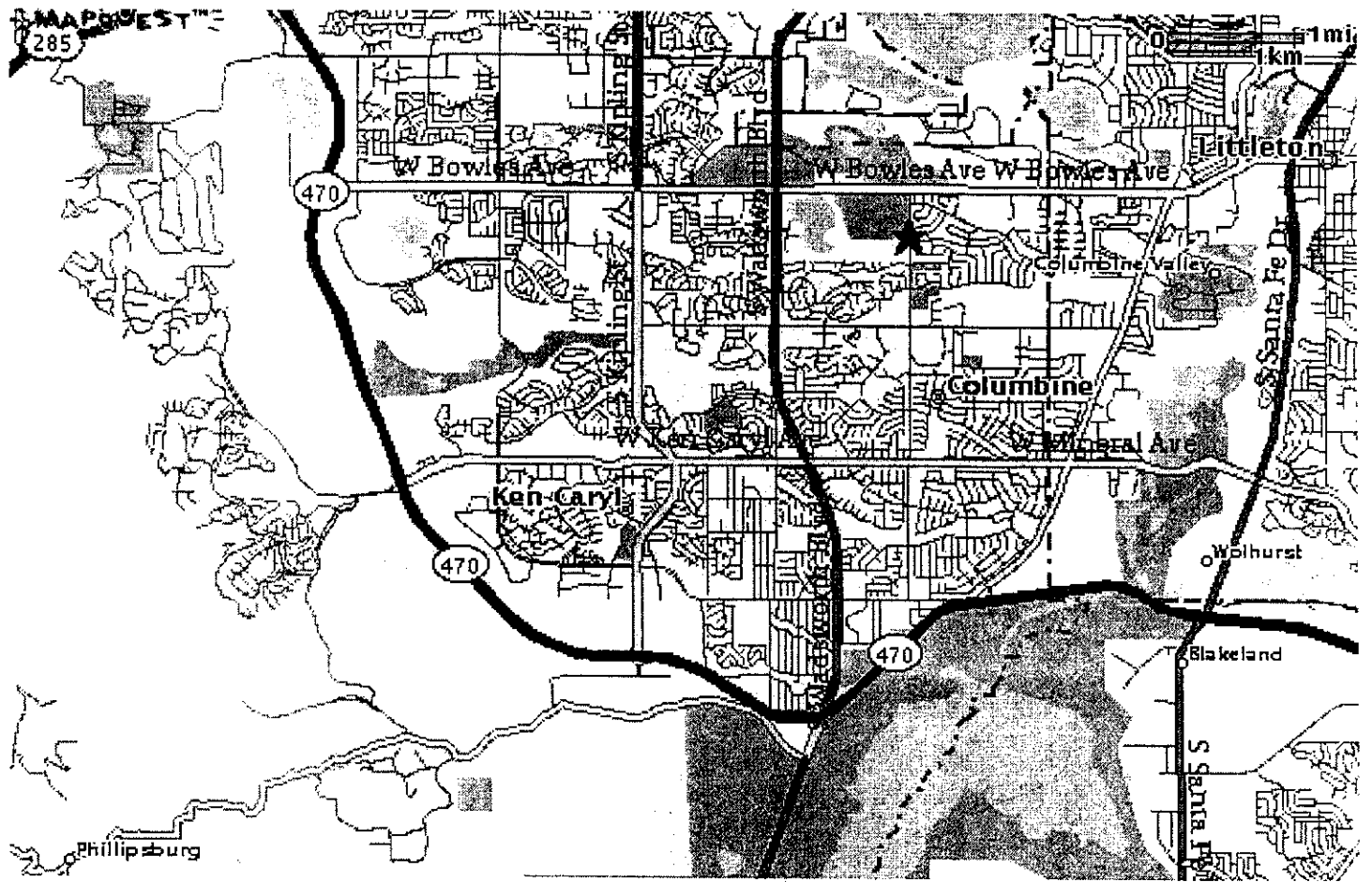

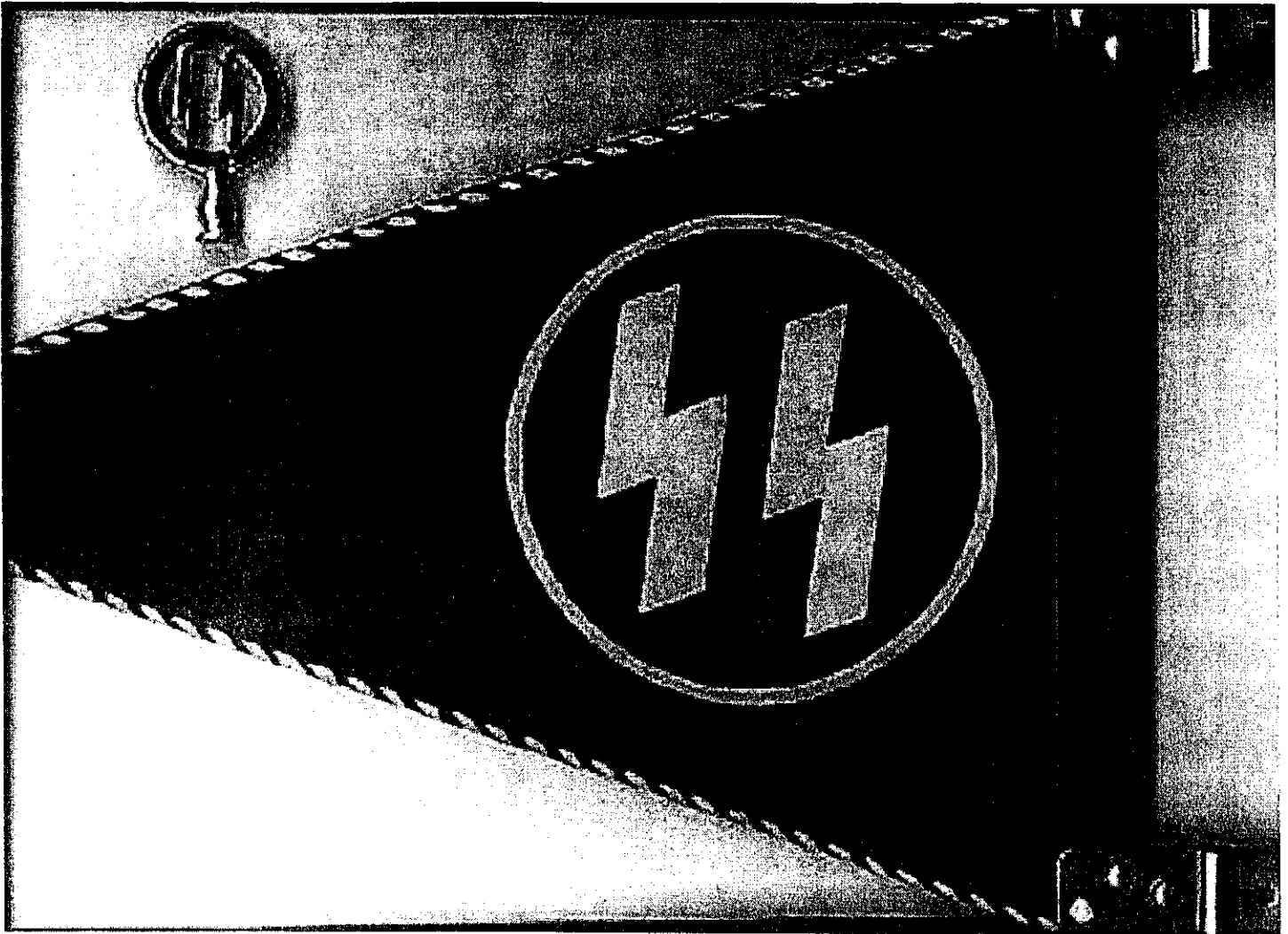

JC-001-026837

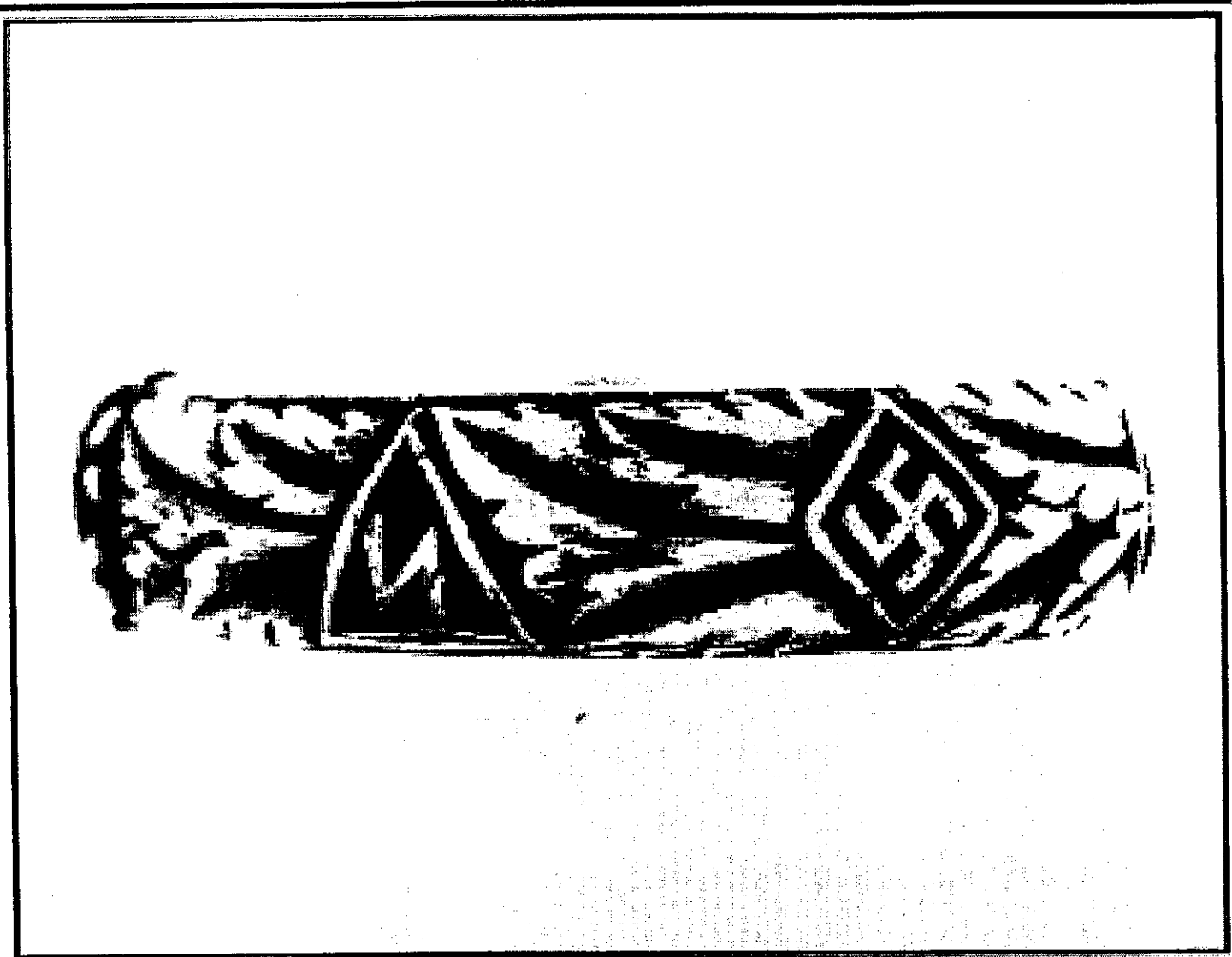

JC-001-026838



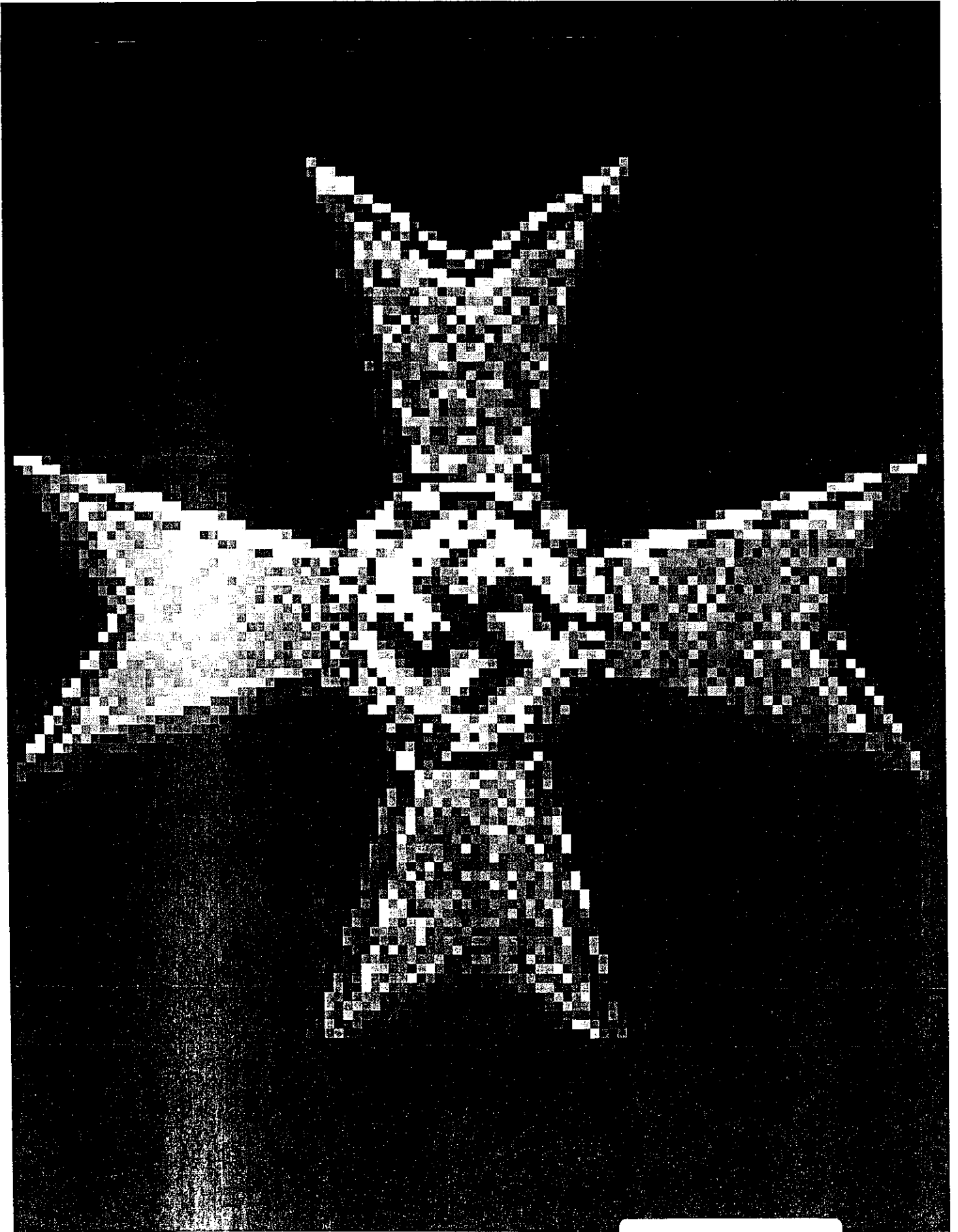

JC-001-026840

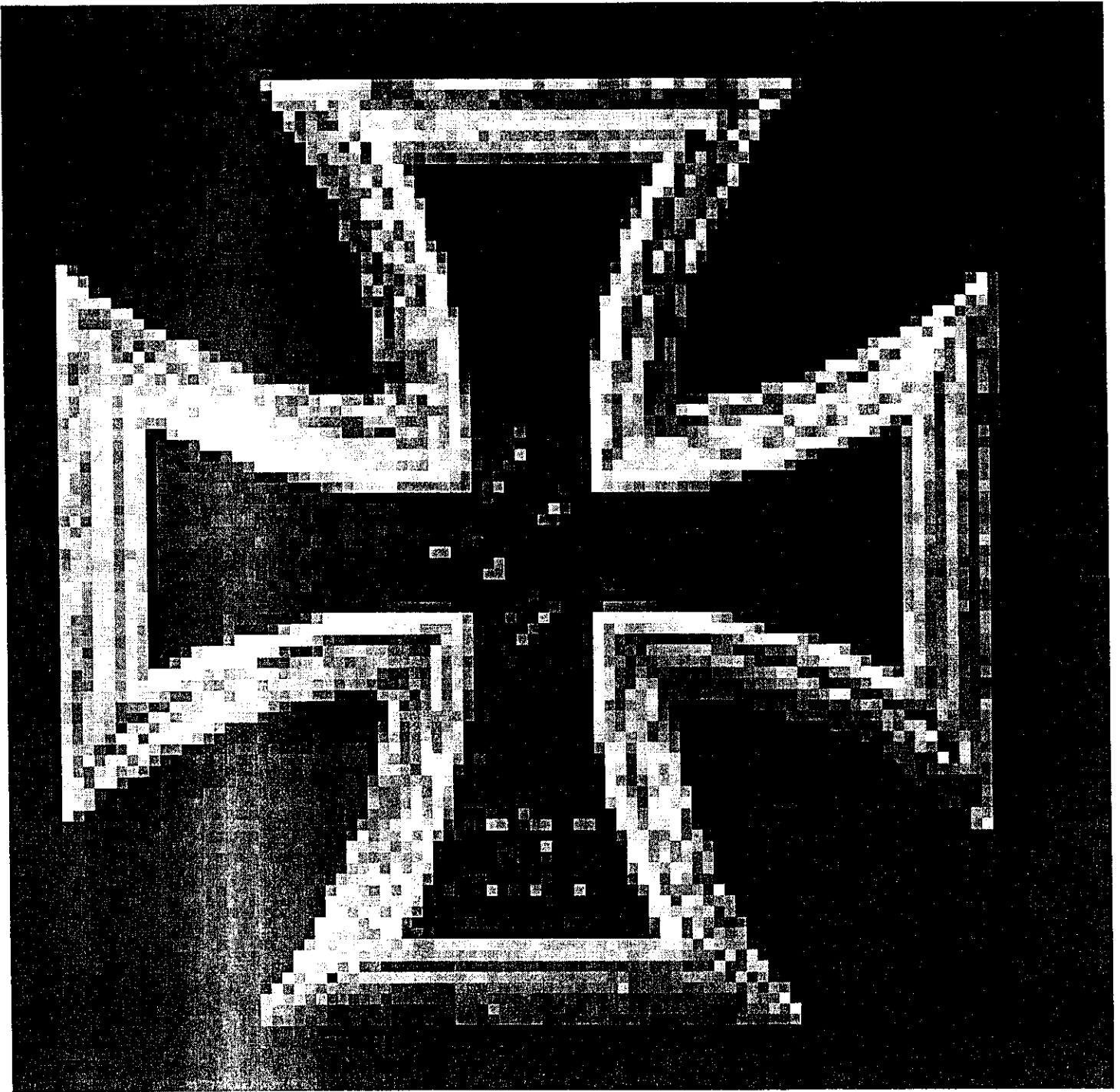

JC-001-026841



JC-001-026842

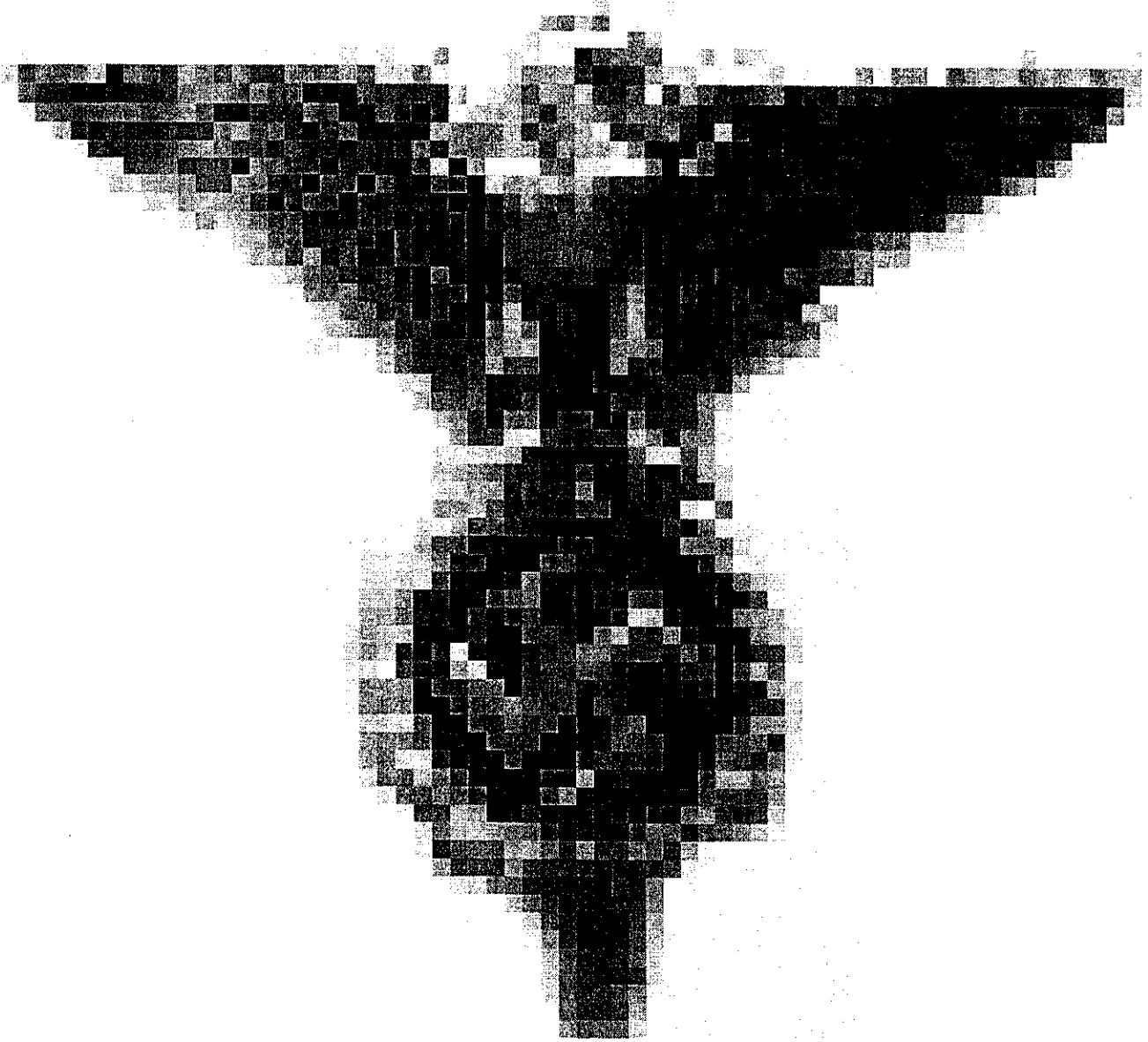

JC-001-026843

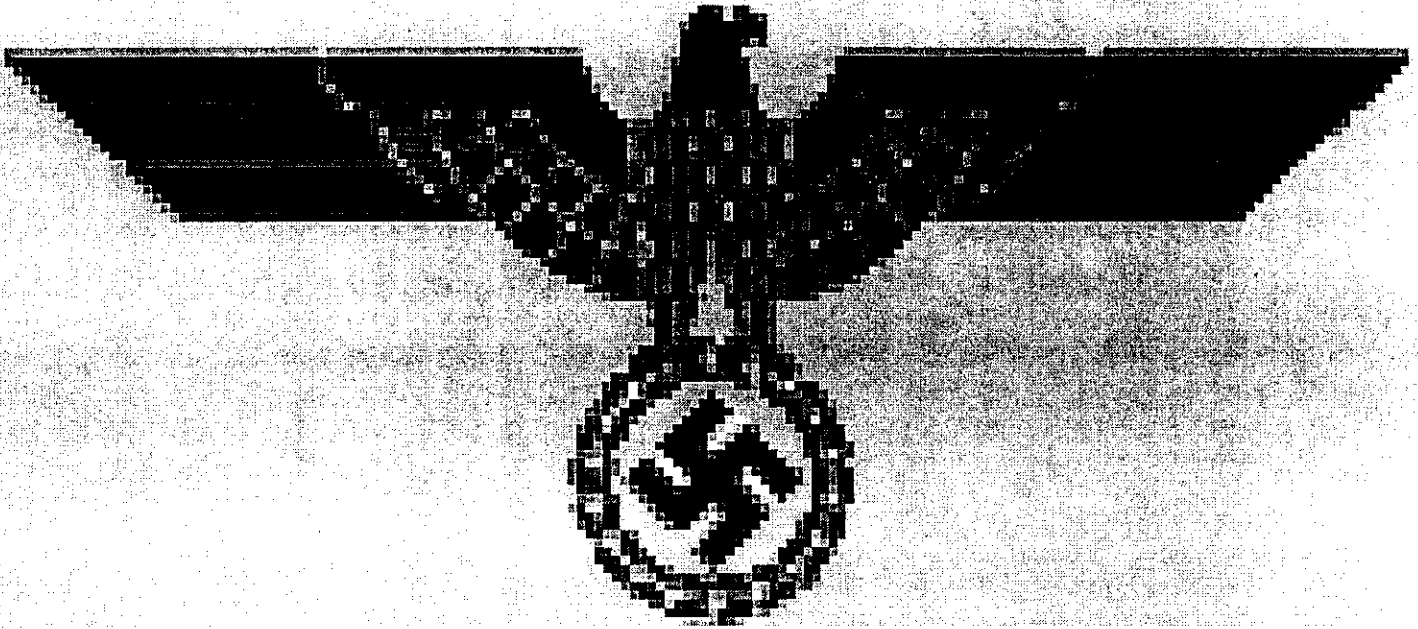

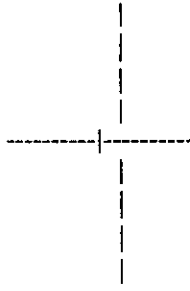

```

=====
Title       : TIER
Filename    : TIER.WAD
Author      : REB
Email Address : REBdomine@aol.com
Misc. Author Info : I have been playing doom since November of 1994, so it is
                    basically my life. These levels are better than anything you have
                    ever seen before. I don't want to brag about my own sh*t, but
                    these levels come from the Herrgott of DOOM himself...so just
                    play each one, and dont miss any rooms, and you'll see why I say
                    these are the best levels ever.

How to Play : Load up the de hacked patch and run "doom2 -file tier.wad -fast
                    -warp 01" and if you are using DM.exe to do a deathmatch or coop
                    game, run "dm.exe -fast". Anything else, you figure it out on
                    yer own.

Description : Tier is a 7 level patch for doom2. It has 6 new monsteres, 2 new
                    guns, 9 new gory sprites, a few new sounds, new music, and tons of
                    new textures. The theme for these levels is totally Phobos-base
                    post-war UAC lab type stuff. So just imagine returning to good
                    old episode 1 of doom with a ton of new twists. I even put in an
                    actual part of the orginal doom in the first level. It's very
                    nice, and not to hard to find. Lots of the rooms and secrets in
                    this place come directly from my imagination, so you are basically
                    running around in my own world. I live in this place. I mean a
                    person could write a freakin book on all of the symbolism and
                    double-meanings used in these levels. So show some respect, ya
                    bastages.

```

Advice from REB:

First things first, use the f*ckin map. You will never find all of the secrets or atleast above 80% without it. Almost all of the secrets are visible on the map, and they aren't to hard to find.

Second: Each level has 4 symbols in it, locate all of them and you are Godlike.

Third: Watch the demo.

Forth: If you are playing with fast mode on, and you should be, you can NOT save your game, if you do save it some wierd ass bug f*cks up the game and some twecky stuff happens to it, so don't save when on fast.

Fifth: Remember this about the machine gunners: They have bad aim when you are more than about 5-10 feet away. So use that to your advantage. Plus watch the first demo to find out how to beat the blue key battlefield in map3.

Sixth: Do not try to use the cheat codes, except for idcleve. They have all been changed besides that one, so if you try to type one in the game will bomb you out. If you are having a hard time beating a level, then play it without fast mode on, so then you can save your game and it'll be easier. I want you people to

see everything in every level, not get your asses kicked every other room.

Story : Once the demon was destroyed on Earth the war seemed over for you. However, the re-taking of Earth had just begun. Helping out here and there with teams of marines to take over our lost cities, you grew tired of the same old battles. When you heard reports that Phobos was becoming an active base for demons again, you made a final decision. You will return to Phobos and finish the job. You will destroy every damn monster on the whole friggin rock and take over every base that you missed during the first siege. What do you have to live for anyway? Every friend you had was wasted on Phobos and your family was killed on Earth, so why the hell not? 7 installations were skipped during your first battle. You knew that a few teams made it over to those bases, but all of them were killed off before you even made it through the hanger. So you pack up a few things and head on back to Phobos. The 9 bases that were already passed through are basically in the same condition you left them in, which was only a few weeks ago. The new bases that you are going to have been "worked on" a little by the aliens. So expect some unusual architecture and probably some ambushes. They know you're coming. One other thing, keep an eye out for new weaponry. There are 2 UAC weapons that you saw training videos on months ago, but never found in the bases. One is an earlier version of the BFG9000, and the other is a modified plasma rifle. Both, as you remember, are very good at getting rid of enemies real damn quick.

Additional Credits to : VoDkA, DevilMan, Grunt, ID Software, the creators of EdMap, BSP, Wintex, PSP 5, DeHacked, and DCK. KMFDM, RAMMS+EIN, NIN, Orbital, The Orb, The Future Sound Of London, Steven Spielberg, Slim Jims, Salsa Sunflower Seeds, Coke, and the authors of the DooM novels.

=====

* Play Information *

Map Number : MAP01-MAP07, game ends after map7 is completed!

Single Player : Yes

Cooperative 2-4 Player : Yes

Deathmatch 2-4 Player : Yes

Difficulty Settings : Yes, don't wuss out.

New Sounds : Yes

New Graphics : Yes

New Music : Yes

New Weapons : Yes, the gun of God and the RFG

New Monsters : Yes, a red machine gunner, an unstable Former Human, a hyperactive Lost Soul, a new breed of Imps to play with the old ones, a sentry, and the spidermind had a few adjustments.

Demos Replaced : All

* Construction *

Base : New levels from scratch

Editor(s) used : EdMap, BSP, Wintex, Dehacked, and DCK to fix a few f*ckin bugs.

Known Bugs : The only thing I know of is that the game gets screwed up when it is saved while on fast mode. Other than that, it should be fine.

Authors may NOT use this level as a base to build additional levels.

You MAY not distribute this WAD file in any format.

* Where to get this WAD *

From me. You must either have my permission to have a copy of this or have actually purchased a copy from me.

X2_g+++|"Kein mitleid fur die merheit"
The shit list



.....10JQJ

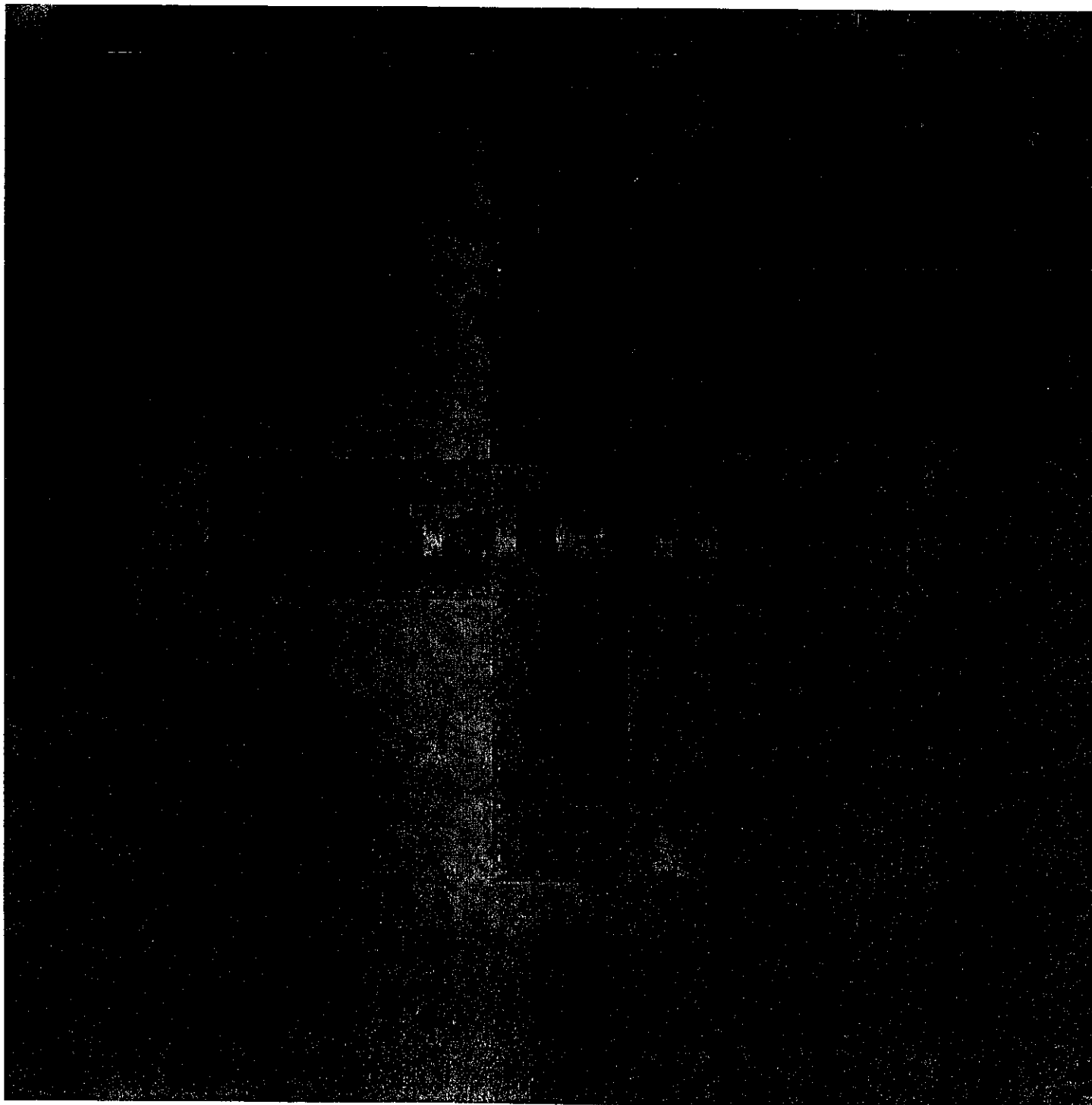

DELTA FORCE IS IN MONTANA. FUCK BICH.
TODAY. HELP LIGHT US SAVE US.
MEGALOMANIACAL. INSANE IS ONLY A
WORD. AUSLANDER. CHICO.
E

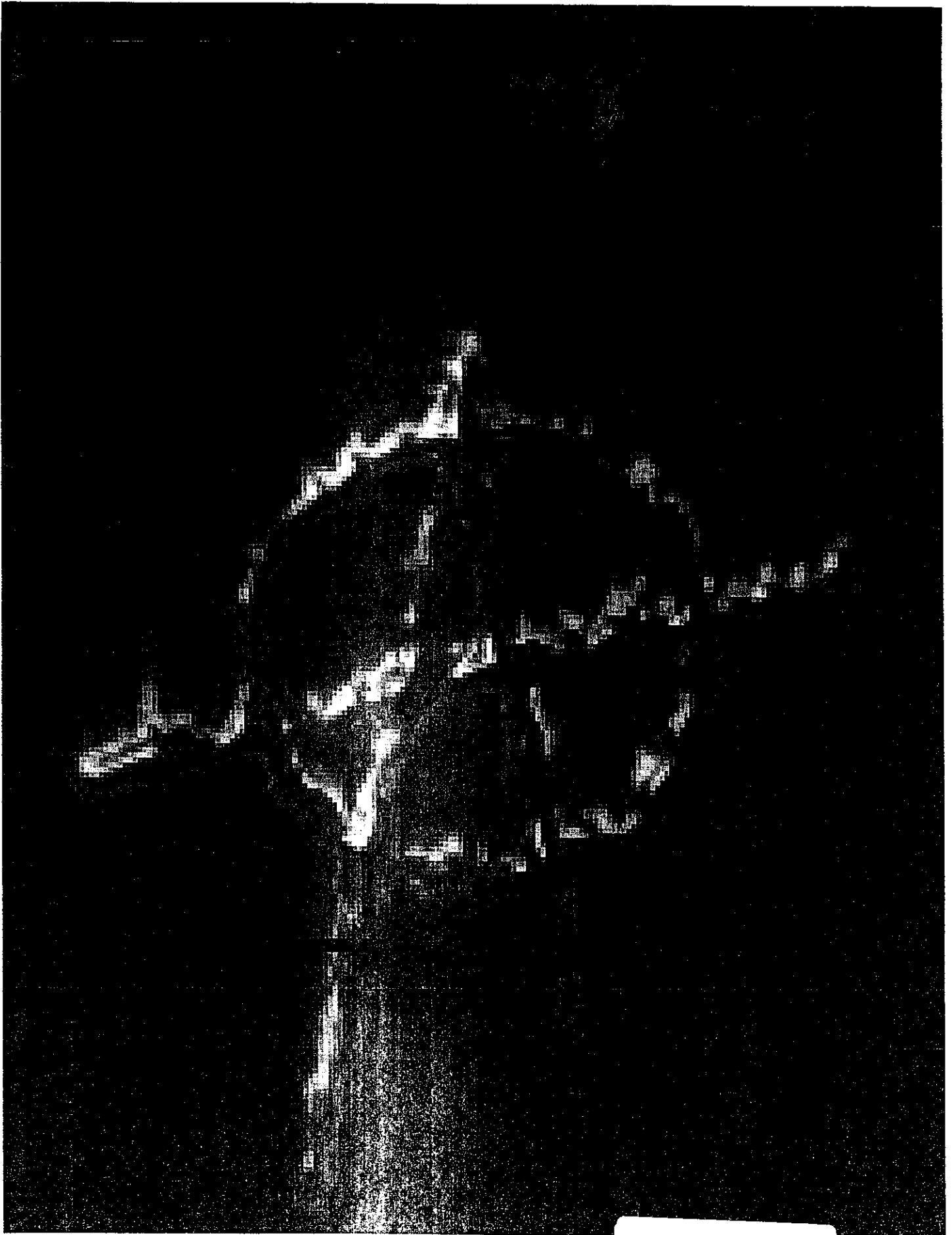

JC-001-026851

bjbj_W_W

V0æ=æ=|_____]ÆÆÆÆÆÆÆ\$_____4SL_K°aaaaaaaa\$C_7j6Æaaaaa6_ÆÆaaa__ä"ÆäÆä|+"ÆÆÆÆÆä`_ÆÆäp+
ó+_ë+_ª

[REDACTED]
Prattsburgh, NY 12901

[REDACTED]
Ft. Walton Beach, FL 32547

[REDACTED]
Littleton, CO 80128

[REDACTED]
Hayden, ID 83835

[REDACTED]
Parker, CO 80134

[REDACTED]
Parker, CO 80134

[REDACTED]
Pleasanton, CA 94566

[REDACTED]
Dayton, OH 45419

[REDACTED]
Lakewood, CO 80228

[REDACTED]
Denver, CO 80222

[REDACTED]
Parker, CO 80134

[REDACTED]
Lakewood, CO 80228

[REDACTED]
Denver, CO 80222

[REDACTED]
Poquoson, VA 23662

[REDACTED]
Littleton, CO 80122

[REDACTED]
Highlands Ranch, CO 80126

[REDACTED]
Denver, CO 80231

[REDACTED]
Denver, CO 80231

Plattsburgh, NY 12901

Ft. Walton Beach, FL 32547

Littleton, CO 80128

Hayden, ID 83835

Parker, CO 80134

Parker, CO 80134

Pleasanton, CA 94566

Dayton, OH 45419

Lakewood, CO 80228

Denver, CO 80222

Parker, CO 80134

Lakewood, CO 80228

Denver, CO 80222

Poquoson, VA 23662

Littleton, CO 80122

Highlands Ranch, CO 80126

[REDACTED]

[REDACTED]

[REDACTED]

[REDACTED]

[REDACTED]

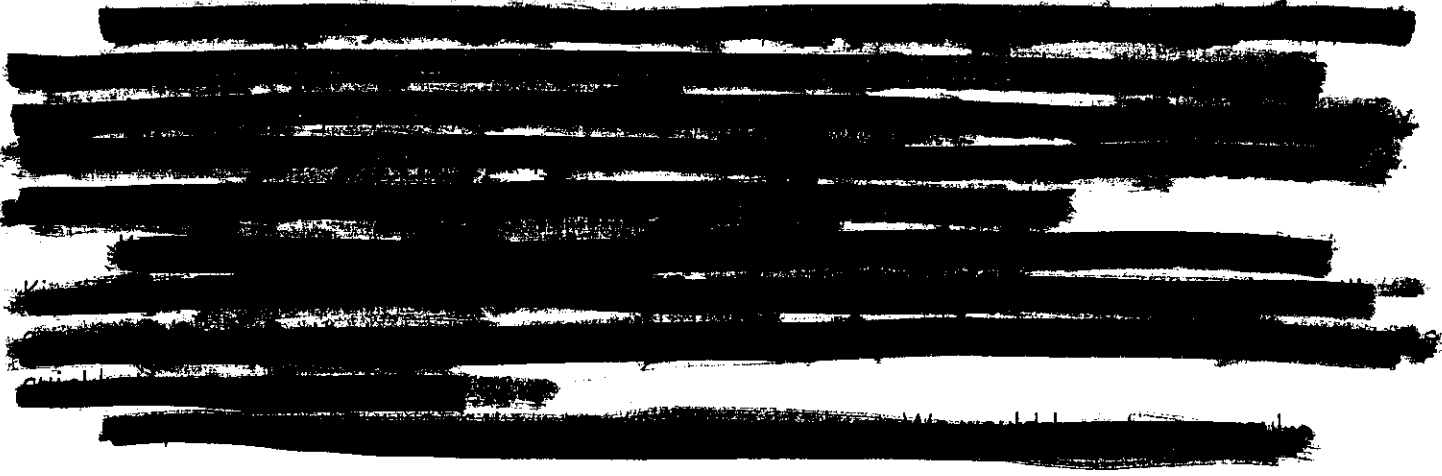

It would be great if god removed all vaccines and warning lables from everything in the world and let natural selection take its course. All the fat ugly retarded crippled dumbass stupid fuckheads in the world would die, and oh fucking well if a few of the good guys die to. Maybe then the human race can actually be proud of itself. World war II is the last time I bet America was proud of its self. We beat the fuck out of the damn zipperheads and the nazis. We came back, from being bombed and loosing major battles to nuke that little piece of shit island and to take over that cool place called Deustchland. I say its cool because I love the German language and "BRUTE" stuff. Kein mitleid fur die merheit. Put everyone in doom I and see who can get past atleast level 1. Actually, then put them into MY worlds. Like Thrasher, Whiskey, UAC Labs, und TIER. I would love to see all you fuckheads die. NBK. I love it! sometime in april me and V will get revenge and will kick natural selection up a few notches. Armed with the following; a terroist bag full of noisey crickets, noisey crickets strapped to WD40 cans, pipe bombs with a shit load of shrapnel, fire bombs, chlorine gas bombs, and smoke bombs. Fire arms we arent sure of yet, hopefully V will have his #3 and plenty of ammo for it. thats another thing, ill fuck around with some shotgun shells for more bombs also. For me, I don't know what weapon ill have. I just want a firearm that can hold lots of bullets and that wont jam on me. So ill need lots of clips to. Ill have those strapped onto my chest. Maybe a bullet proof vest too. We will be in all black. Dusters, black army pants, and we will get custom shirts that say R or V in the background in one big letter and NBK in the front in a smaller font. We will have knives and blades and backup weaponry all over our bodies, I will have a tattoo of REB on my right arm. Once we start we will wear balaclavas. First we will go to the house of [REDACTED] and [REDACTED] in the morning before school starts and before anyone is even awake. We go in, we silently kill each inhabitant and then pin down [REDACTED] and [REDACTED]. Then take our sweet time pissing on them, spitting on them, and just torturing the hell out of them. Once we are done there we set time bombs to burn the houses down and take any weaponry that we find, who knows we may get lucky. Then get totally prepared and during Alunch we go in and park in our spots. With sunglasses on we start carrying in all of our bags of terrorism and anarchism shit into our table. Being very casual and silent about it. its all for a science/band/english project or something. Then, we sit down, play some pumpup music, light a 50\$ stoge, and get ready to start throwing out the first wave of crickets. Then, we light them, and throw them as far as we can, once the first wave starts to go off and the chaos begins, V opens fire and I start lobin the firebombs. Then I open fire and V starts lobin more crickets. Then if we can we go upstairs and go to each classroom we can and pick off fuckers at our will. If we still can we will hijack some awesome car, and drive off to the neighborhood of our choice and start torching houses with molotov cocktails. by that time cops will be all over us and we start to kill them to!we use bombs, fire bombs, and anything we fucking can to kill and damage as much as we fucking can. if it comes to the time when we are trapped with absolutely no way out, we eat crickets along with a ton of chlorine or some other deadly gas. so when we die, so will anyone close to us. if we have figured out the art of time bombs before hand, we will set hundreds of them around houses, roads, bridges, buildings and gas stations. anything that will cause damage and chaos. if you have ever seen the first few clips of violence in INVASION USA youll know what im talkin about. itll be like the LA riots, the oklahoma bombing, WWII, vietnam, duke and doom all mixed together. maybe we will even start a little rebellion or revolution to fuck things up as much as we can. i want to leave a lasting impression on the world. and god damnit do not blame anyone else besides me and V for this. dont blame my family, they had no clue and there is nothing they could have done, they brought me up just fucking fine, dont blame toy stores or any other stores for selling us ammo, bomb materials or anything like that because its not their fault, i dont want no fucking laws on buying fucking PVC pipes. we are kind of a select case here so dont think this will happen again. dont blame the school, dont fucking put cops all over the place just because we went on a killing spree doesnt mean everyone else will and hardly ever do people bring bombs or guns to school anyway, the admin. is doing a fine job as it is, i dont know who will be left after we kill but damnit dont change any policies just because of us. it would be stupid and if there is any way in this fucked up universe we can come back as ghosts or what the fuck ever we will haunt the life out of anyone who blames anyone besides me and V. if by some wierd as shit luck my and V survive and escape we will move to some island somewhere or maybe mexico, new zelend or some exotic place where americans cant get us. if there isnt such place, then we will hijack a hell of a lot of bombs and crash a plane into NYC with us inside iring away as we go down. just something to cause more devistation.

0.
è+..+^_Pipe bombs.

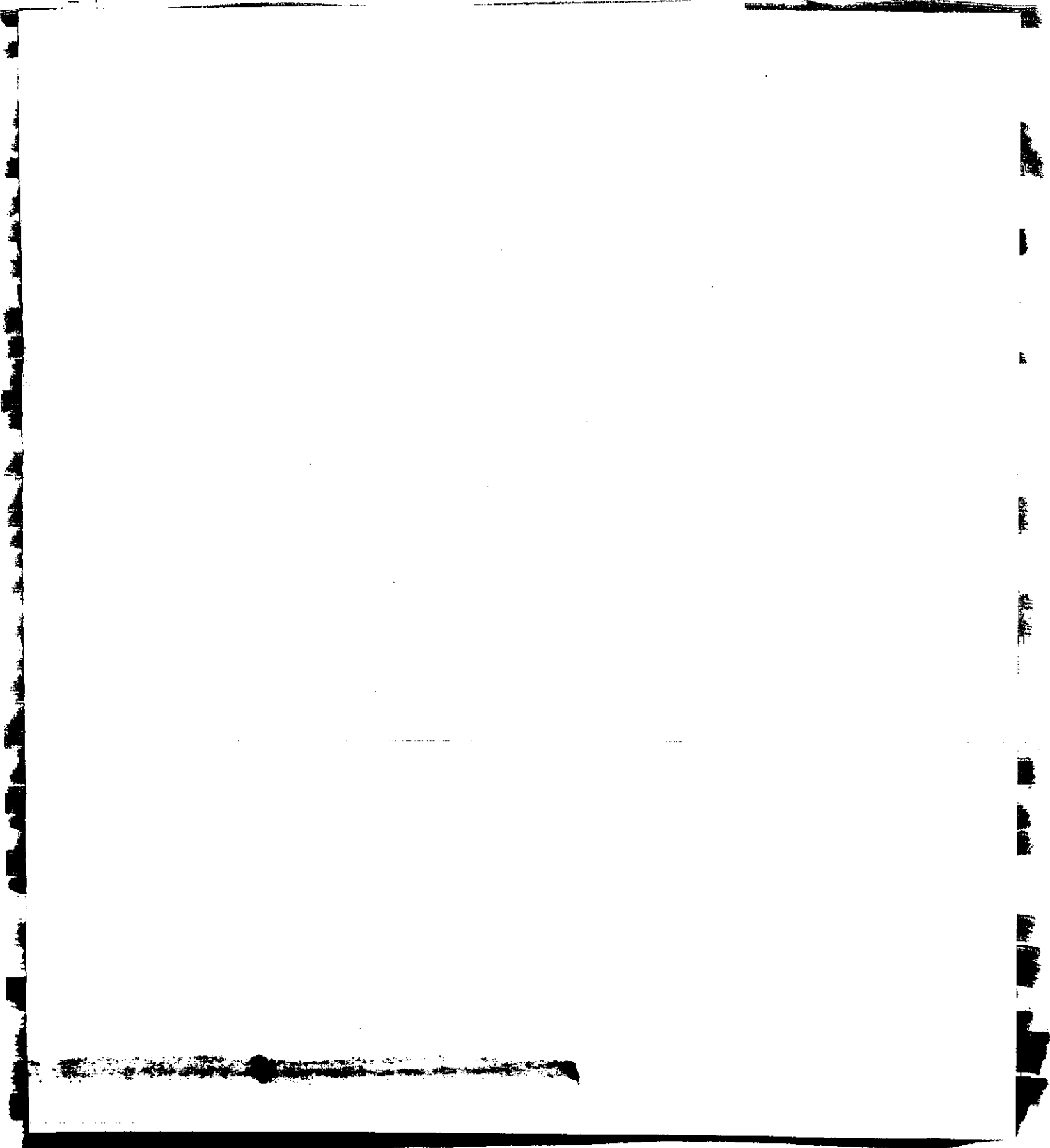

Napalm.

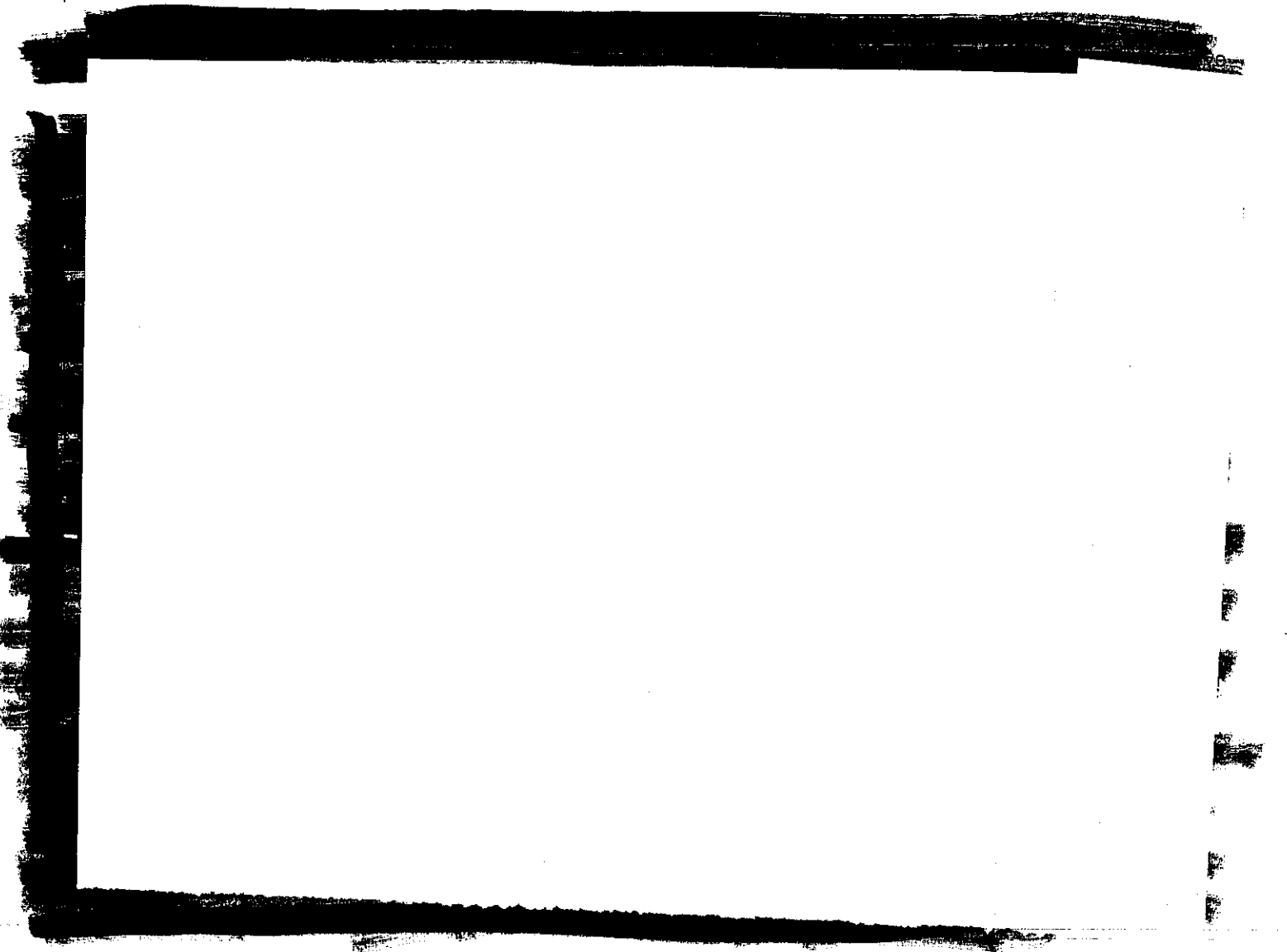

The document described below
has been removed

Description of Document: Emails of
Wayne Harris unrelated to the
investigation

Date of Document: N/A

Reason for Removal

- Copyright
- Bomb-making instructions
- Medical Records
- Other

Comments: Not related to the
Investigation

<HTML>--send this to everyone you know. the more who know about me the better.
1. Full name: Eric Harris 2. Nicknames: REB, reverend, indigo, WAR 3. Birthplace: wichita, KS 4. Birthday: 4/9/81 5. Where Do You Live Now?: hell. a few days ago people called it littleton.(denver) 6. Parent(s): Wayne and Kathy 7. Sibling(s): Kevin 8. Looks: 5'10" 140. skinny but handsom, some say 9. Favorite Animal(s): Dogs, bald eagles 10. Favorite TV Show(s): i hate TV 11. Favorite Kind(s) Of Music: industrial 12. Favorite Movie(s): Lots highway 13. School: former Columbine high school 14. Future School: none 15. Future Job: none 16. Boyfriend/Girlfriend: Nope 17. Best Buds: the 4 horsemen. me(war), vodka(death), (famine), (pestilence) 18. Favorite Candy: slim jims 19. Hobbies: doom. guns 20. Things You Collect: fireworks. gun powder 21. Do You Have A Personal Phone Line: kinda. its the computer line too 22. Favorite Body Part Of The Opposite Sex.? legs. 23. Any Tattoos And Where Of What?: Not yet 24. Piercing(s) And Where?: hell no 25. What Do You Sleep in?: Boxers 26. Do you like Chain Letters: burn em 27. Best Advice: follow instincts 28. Favorite Quotes: kill em all. lets rock. BUCK DICH 29. Non-Sport Activity You Enjoy: Computer, shooting 30. Dream Car: hummer 31. Favorite Thing To Do In Spring: shoot stuff. blow up stuff 32. What's Your Bedtime: whenever 33. Where Do You Shop?: try not to. army surplus or hot topics. even though its a trendy little place 34. Coke or Pepsi: Coke 35. Favorite Thing(s) To Wear?: black stuff and sunglasses 36. Favorite Subject(s) In School?: Bowling 37. Favorite Color(s): black 38. Favorite People To Talk To Online: in CSU 39. Root-Beer or Dr. Pepper? toss em both 40. Do You Shave? when i feel like it 41. Favorite Vacation Spot(s): mountains 42. Favorite Family Member(s): Bro 43. Did You Eat Paint Chips When You Were a Kid? No 44. Favorite CD you own: a custom burn of gothic industrial stuff 45. The ONE Person Who You Hate The Most: are cops one person? 46. Favorite Food(s): salsa sunflower seeds and slim jims 47. Who Is The Hottest Guy or Girl In The World? something. a few others 48. What Is Your Favorite Salad Dressing?: ranch 49. When You Die, Do You Wanna Be Buried or Burned Into Ashes? Burned 50. Do You Believe In Aliens?: you bet your probbed ass i do 51. If You Had The Chance To Professionally Do Something, What would You Do?: blow up things 52. Things You Obsess Over: guns bombs doom 53. Favorite Day of the Week: friday 54. A Teacher You Hate: 55. Favorite Disney Movie: burn em all 56. What Is Your Favorite Season?: summer 57. What Toppings Do You Like On Your Pizza?: peproni and green peps 58. Do You Like Your School Food Itself (As In The District Food): 59. If You Could Live Anywhere, Where Would You Live? phobos 60. Favorite Thing(s) To Do On Weekends: bowl and get stoned 61. Favorite Thing(s) To Get Clean up: eh? 62. Favorite Magazine(s): guns and ammo, penthouse, time 63. Favorite Flower(s): this chinese one i saw 64. Favorite Number(s): 7, 666 65. Favorite Ice Cream flavor(s): cookie dough!!!! 66. What Kind of Guys/Girls Are You Attracted to?: sexy and fun ones 68. What's Your Most Embarrassing Moment? getting arrested 69. If You Could Change One Thing About Yourself What Would It be? weight 70. Do You Eat Breakfast First Then Brush Your Teeth or Brush first then eat breakfast: i eat breakfast and then i brush my teeth 71. Favorite Time of Day: 2am 72. Can A Guy and Girl Be Just "Best Friends?": i guess 73. Do You Ask the Girl / Guy Out Or Do You Wait For Them To Come To You?: ask em out 74. Do You Mind Paying For Sex? depends on who its with, but no not really 75. What's The Most Important thing In Someone's Personality?: compassion 76. Do you have a pager or cell phone? hell no 77. Favorite Sport: soccer 78. What Was the Best Gift You Ever Received? my 86 honda prelude 79. How Long Did This Letter Take You To Finish?: 5 min 80. What Did You Listen To While Completing It?: Nothing 81. Are you or would you like to be married in the near future (next 5 years)? no 82. Don't u just hate how psychics never win the lottery? would rather rob.</HTML>AOLF